

# SILICON CHIP



DECEMBER 2007

ISSN 1030-2662  
9 771030 266001 12  
PRINT POST APPROVED  
- PP255003/01272  
**\$850\*** NZ\$990  
INC GST INC GST

## BUILD THESE SENSATIONAL RIBBON TWEETER SPEAKER SYSTEMS



PERFECT  
for stereo or surround sound!



45-Second  
Voice  
Recorder

Hi-Tech  
Christmas  
Gift Ideas



Bringing a  
Vintage TV  
Back to Life

*Sensational sound from ribbon t*

# Build the *Signature*

*These new speakers are among the very  
They use the very-high-performance Founte  
They will be a very good match to our-recent*

Design by RUSSELL STOREY



***tweeters***

# *Series* Loudspeakers

*best kit speakers that money can buy.  
Peak ribbon tweeters and Peerless woofers.  
Fully described 20W class-A stereo amplifier.*

Words by LEO SIMPSON



At far right is the HD260 tower system and its dimensions while below is its centre channel variant the HD260C. The HD360, at right, uses a 6.5-inch woofer. The pick of the two systems is the HD260 because of its considerably higher efficiency: 92.5dB/1m/1W. Both systems produce commendably low harmonic distortion.

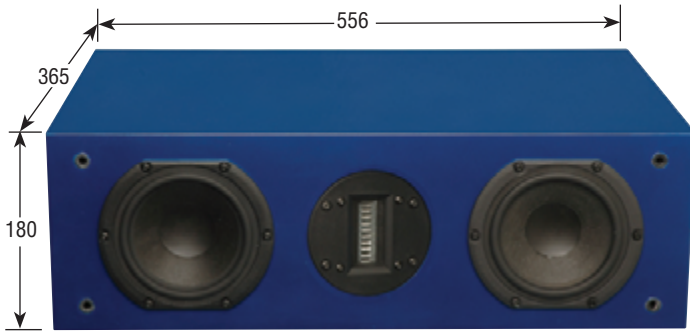

**S**ince we completed our description of the 20W class-A stereo amplifier a few months ago, readers have been asking us for a kit speaker system to match its performance.

As it happens, the Signature Series have been in development for over a year now and we are very pleased to present a complete set of speakers which can be used in stereo or home theatre systems.

They provide excellent stereo spread and definition, very wide and smooth frequency response with very low harmonic distortion. And while they are eminently suitable for our Class-A amplifier, they can be matched up to any amplifier with a power output up to 120 watts per channel, when running normal program material.

The heart of these speakers are the very high performance Fountek ribbon tweeters. For those who are not familiar with ribbon tweeters, consider them as an extremely light filament of aluminium foil suspended between the poles of an extremely strong magnet. The audio signal from the

amplifier is passed directly through the ribbon and the interaction of the current with the strong magnetic field deflects the ribbon back and forth to produce sound.

Incredibly, such an apparently flimsy system can produce deafening sound levels and with unsurpassed fidelity, transient response and so on.

Ribbon tweeters have been around for a long time but until recently they have been largely confined to very expensive esoteric loudspeakers systems and their reliability and ruggedness was always a little suspect.

In the particular Fountek JP3.0 ribbon speakers featured here, the aluminium ribbon weighs a mere 11 milligrams and is just 9 microns thick – much thinner than the proverbial human hair!

The aluminium ribbon is 66mm long and 8mm wide and suspended between the poles of a Neodymium magnet with a gap flux of 0.6 Tesla.

As you might expect, such a short piece of aluminium represents a very low resistance and it cannot be driven

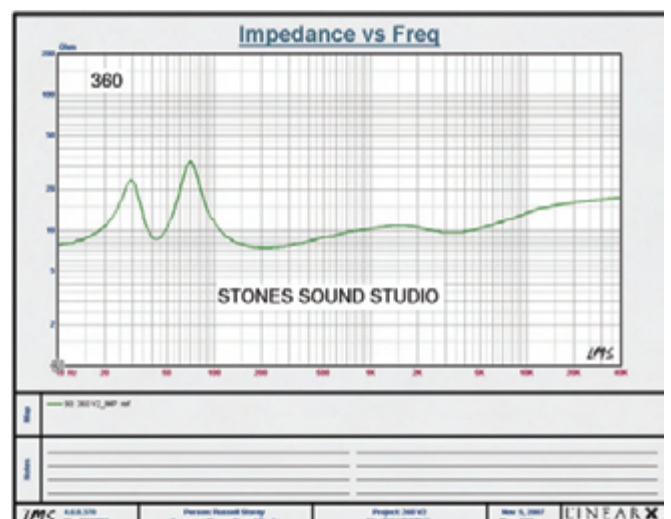
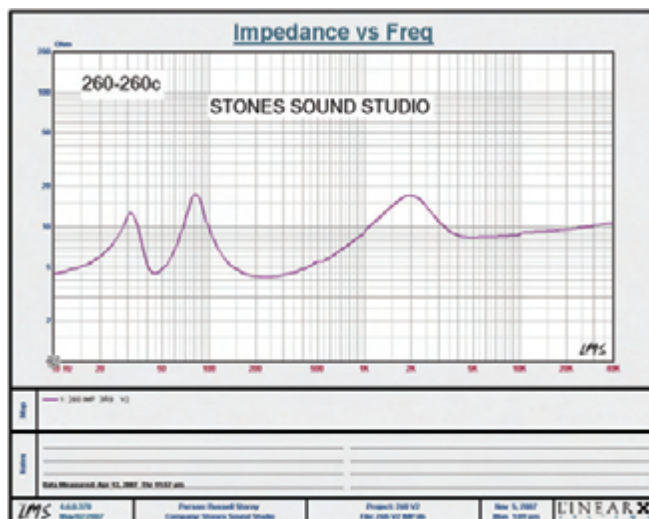

The impedance curves for both the Signature Series speaker systems show the classic “double hump” at the bass end, due to the tuning provided by the bass reflex port.



This series of photos show the lineup of the drivers used in the Signature series. The woofers are made by Peerless and both have rugged dies cast chassis. The ribbon tweeter is made by Fountek and incorporates very high quality matching transformer. Note the fine mesh protecting the ribbon from curious fingers.

directly by any normal audio amplifier. Hence, the tweeter has an integral matching transformer with a frequency response to 120kHz. This results in a very flat tweeter impedance of  $7\Omega$  from 1kHz to 40kHz. The basic tweeter is also extremely efficient and in fact, is used with resistive attenuation to match the Peerless woofers used here.

Two separate stereo pairs of loudspeakers are presented, the Signature Series HD260 and HD360 systems. In addition, a centre channel variant of the HD260, the 260C was designed to complement the 260 and 360 for high-end Home Theatre A/V systems.

Depending on your budget, you may decide to build



The overall frequency response of the Signature Series HD260 and HD360 speakers is commendably flat to below 50Hz. This is the response of the HD260.

either the HD260s or HD360s for a high performance stereo system. Alternatively, for high-end Home Theatre A/V system, you may decide on a mix of the HD260 (front) and HD360 (rear) together with the HD260C for the centre-front channel.

Whichever approach you take, you can be sure that you will be getting a sensational speaker system. Make no mistake, these ribbon units are the finest tweeters we ever heard. They are so clean in their definition and the pin-point localisation of instruments in a stereo spread has to be heard to be believed.

On top of that, these speakers have very low distortion – measured at around 0.3% THD at 1kHz and 1 watt.

### HD260 & HD360

The HD260 is a small tower speaker using the Fountek ribbon tweeter and two Peerless HDS 832873 5-inch mid/range woofers. This uses a Nomex paper cone, a very large ferrite magnet and neoprene rubber roll surround. The HD260 system has exceptional efficiency of 92.5dB/1m/1W and will provide very good volume levels from the SILICON CHIP 20W class-A amplifier, even in large rooms.

The HD260 is a MTM (midrange-tweeter-midrange) arrangement (also known as D'Appolito) with a rear bass reflex port. The HD260C centre speaker is identical in every respect except that the tweeter is rotated through 90°, so that it will be vertical when the cabinet is laid on its side.

The smaller HD360 bass reflex system uses the Fountek ribbon tweeter and Peerless 830883 6.5-inch midrange woofer, also with a rear port. Its efficiency is somewhat lower but still quite respectable at 87.5dB/1m/1W.

Both speaker enclosures were developed using LEAP

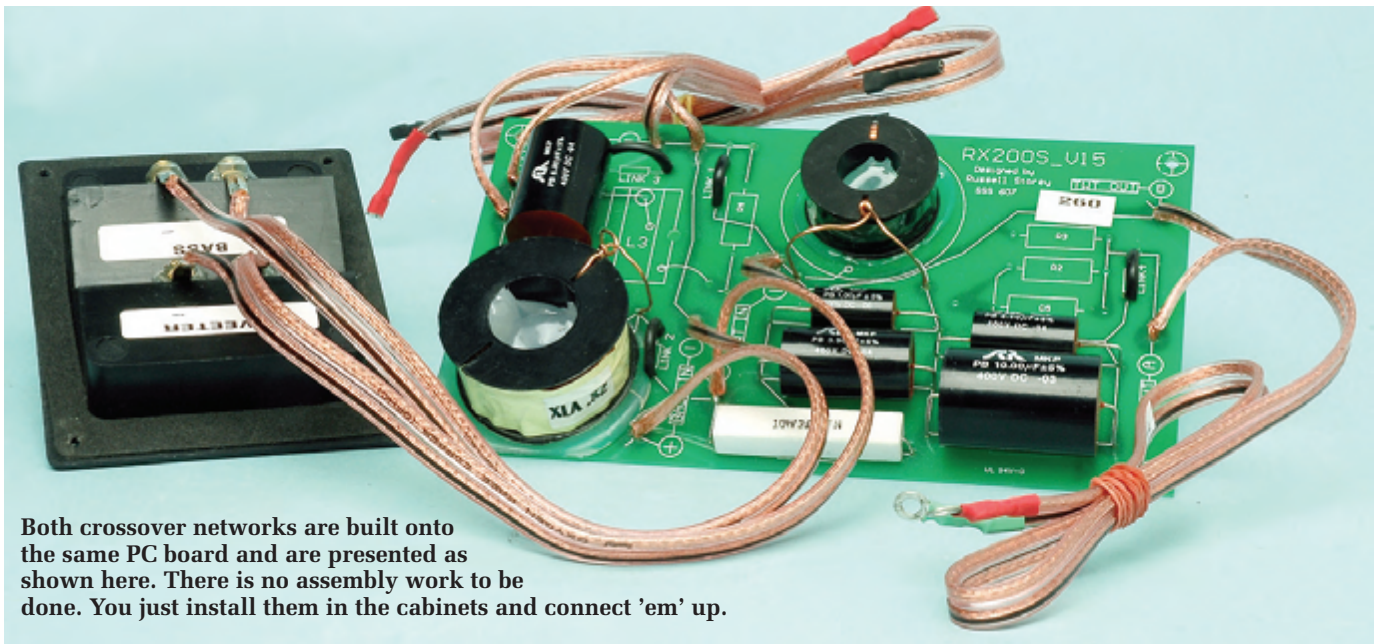

Both crossover networks are built onto the same PC board and are presented as shown here. There is no assembly work to be done. You just install them in the cabinets and connect 'em' up.

5 wave diffraction analyser and FFT vibration analysis software. The resulting enclosures have a Butterworth low pass filter response to ensure optimum bass and transient response.

While the enclosures are relatively small, they are very strong and rigid to ensure very low panel resonances. They are made from 18mm MDF (medium density fibreboard) while the baffle is made from two thicknesses (36mm), to allow the ribbon tweeter to be flush-mounted and still provide maximum rigidity.

In addition, the inside edge of the woofer holes are chamfered to prevent diffraction effects at midrange frequencies and the HD-260 has internal bracing of the large side panels.

### Rear bass port

Both enclosures employ a rear port to ensure a reduction of overall driver distortion and cross-modulation which can be generated by front ports. According to the designer, with a front port a form of speaker (low frequency) distortion and cross modulation is generated by the compressed air exiting the port out of phase with the woofer creating (modulation) interference of the woofer cone. This interference of the woofer cone occurs at medium to high playback levels (port velocity) and is one of the factors reducing overall dynamic range or head-room of the transducers and speaker system.

The port itself is 63mm in diameter with small flared ends. All this is done to keep distortion at a minimum.

### Crossover networks

Using the best drivers and a carefully designed cabinet would be a waste of time without an equal standard in the crossover networks. In the Signature Series the crossover networks are quite complex (Linkwitz Riley with Bessel /Butterworth response). They were developed to enable good linear phase and minimum distortion through the passband and overlap regions of both the woofer and ribbon tweeter.

They have been developed with bi-wiring in mind so

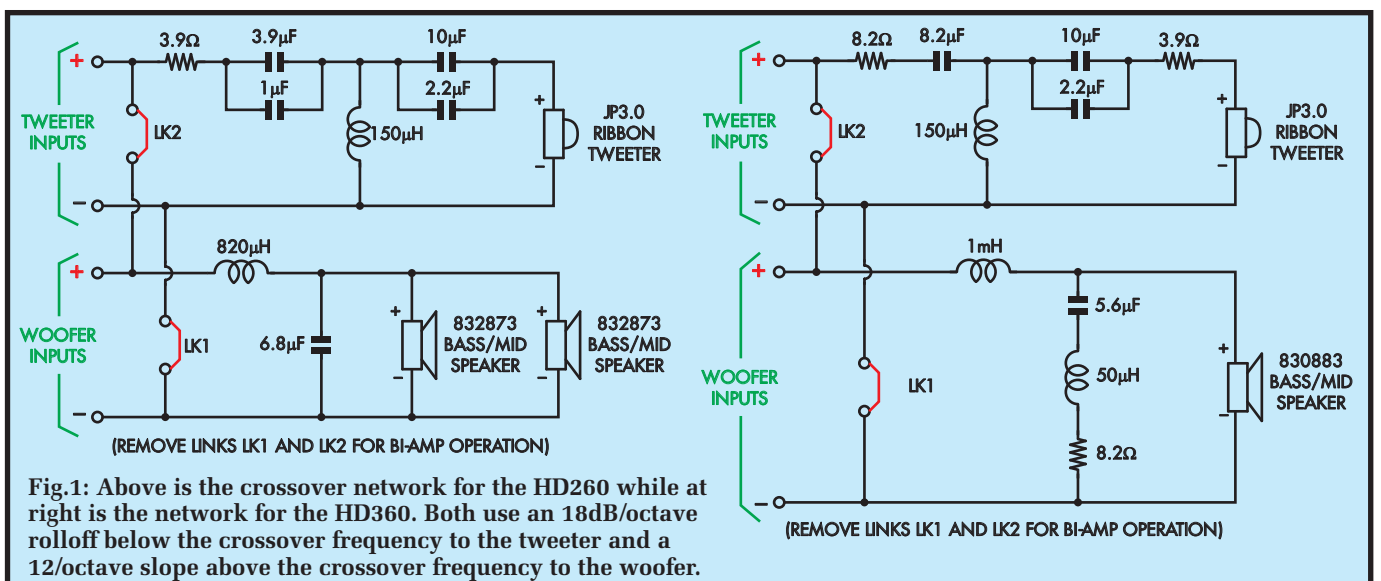
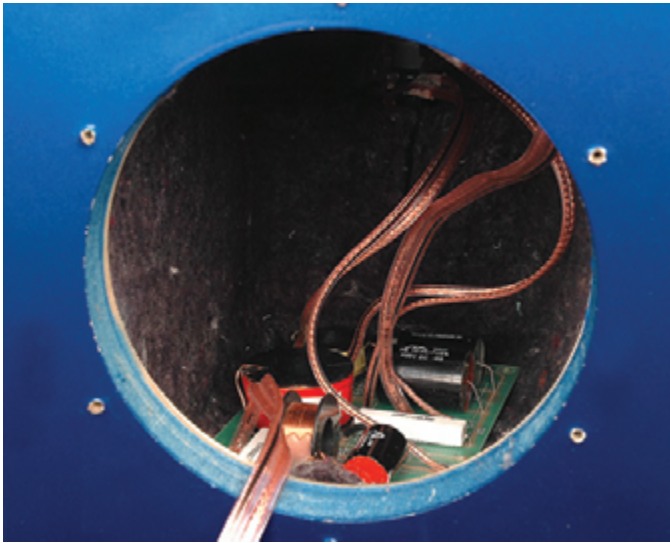

Fig.1: Above is the crossover network for the HD260 while at right is the network for the HD360. Both use an 18dB/octave rolloff below the crossover frequency to the tweeter and a 12/octave slope above the crossover frequency to the woofer.



**This photo shows the crossover network installed in the base of the HD360 enclosure.**

the tweeter and woofer filter networks are essentially quite separate, as shown in the diagrams of Fig.1 & Fig.2.

The tweeter is fed with a third-order high pass (18dB/octave) filter and the woofer is fed with a second-order (12dB/octave) low pass filter. In the case of the HD-260, the crossover frequency is 3.8kHz and 3.2kHz in the HD-360.

Both crossover networks are based on the same PC board but there are differences. Each crossover network employs air-cored inductors, non-inductive wirewound resistors and 400V metallised polyester capacitors. High quality components are used throughout.

### Building them

The designer of these Signature Series loudspeakers has been very particular in specifying how everything must go together, from the initial specification of the drivers, down to the very last detail of the cabinets, crossover components and even oxygen-free copper wiring. We don't think that last detail is really necessary but that is a story for another time.

This very fine attention to detail on the part of the designer has made the task difficult for the kit supplier but it means that you, the ultimate kit-builder, will have an easy time putting them together.

The loudspeaker cabinets are supplied fully assembled in two forms, unfinished MDF or black vinyl. In the case of the unfinished MDF cabinets, it is up to you as to how you finish them.

The prototype cabinets featured in this article were spray-painted to a very high standard. If you have access to a high-pressure spray gun and spray booth, so much the better.

Alternatively, if you intend painting them, we recommend using a roller, to avoid leaving brush marks – it is amazing how brush marks can catch the light and become noticeable, especially if gloss paint is used.

Not only are the cabinets fully assembled but they also come fully lined with a grey felt, to damp internal reflections and they are also supplied with the fully finished grille cloth frames.

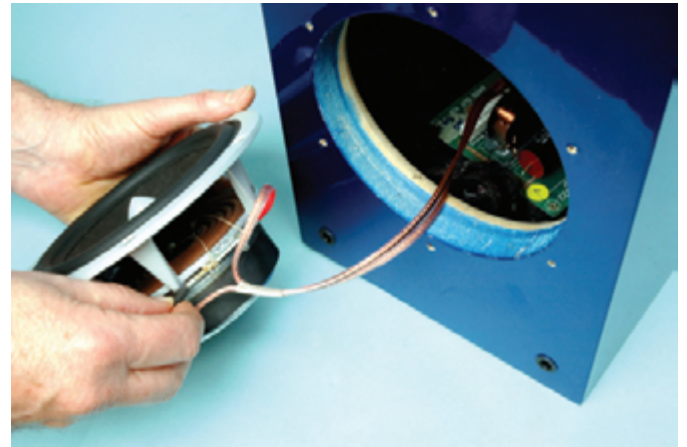

**Making the connections to the woofer. The terminals are colour-coded and differently sized so that you cannot make a mistake.**



**Fit the woofer carefully and do not touch the cone at this point, otherwise you may damage it. It is secured to the baffle with six Allen screws.**



**Making the connections to the tweeter. Do it exactly as the photo depicts. Don't over-tighten the nuts on the tweeters – it would be a shame to damage such a magnificent performer.**

No special tools are required to assemble the kits and no soldering is required. You will need a Phillips head screwdriver, a 3mm Allen key to install the speakers to the baffle and an adjustable wrench to attach the crossover connections to the terminals of the tweeters.

The fully assembled crossover networks even include the wiring to the speaker terminal panels – as we said, there is no soldering at all!

## Order of assembly

The order of assembly is the same, regardless of whether you are putting together the HD260s, HD360s or HD260C (centre speaker). The first step is to install the crossover network in the base of the cabinet. Check the back of the cabinet make sure you do not have it upside down – the rectangular hole for the terminal panel should be below the circular bass port.

Fit six Velcro tabs to the underside of the crossover PC board and then pass it through the lower woofer hole and secure it to the felt on the base of the cabinet. Pass the terminal panel out through the rear of the cabinet, making sure that you do not disturb the felt which covers the rectangular hole. Then secure the panel with four countersunk MDF wood screws.

Bring out the wires for the woofer(s) through their respective holes in the front baffle. Fit the push-on connectors from the crossover speaker cables to the woofer(s). The wires are colour-coded (red for positive and black for negative) are differently sized so that you cannot make a mistake when you do the connections.

Carefully place the woofer into its hole in the front baffle and secure it with six Allen head screws using a 3mm Allen key. It is important that you do not over-tighten these screws otherwise you will strip the holes in the MDF panel.

## Mounting the tweeter

Now is the time to mount the highly prized Fountek ribbon tweeters. Important: do not remove the protection label from the front of the tweeter until you have completed the assembly.

First, check that acoustic cover is fitted behind tweeter cutout hole is in place. Then bring out the tweeter wires from the crossover. These are fitted with colour-coded (red for positive, green for negative) ring terminals to suit the threaded posts of the tweeter.

Make the connections and tighten them with a small adjustable wrench – do not over-tighten them! Hint: angle the connector lugs to allow enough room between the felt cover and back of the ribbon magnet when installing the tweeter.

Then install the tweeter to the front baffle with four Allen head screws. Again – do not over-tighten them. Next, you can carefully remove the protection label from the tweeter faceplate.

## Bi-wiring option

Just back-tracking for a moment – if you intend running these speakers are bi-wired, with separate stereo amplifiers driving the tweeters and woofers, then the installation procedure is slightly different. You need to cut links LK1 and LK2 on the crossover PC boards and then remove the gold plated links from the 4-terminal panels.

Keep the plated links (possibly stick them to the rear of

the cabinets, in case you ever want to run the speakers with conventional amplifier drive (ie, not bi-wired).

A final step is to connect a 1.5V battery across the terminals of the completed loudspeaker. With the battery positive to the red terminal, the woofer cone should move forward. If that's OK, you can fit the grille cloth frames.

You are now almost ready for a listening session. When positioning your speakers in the room, make sure that they are not in the room corners and are out from the walls by around a metre or so. Ideally, they should be placed on stands so that the tweeters are at your ear level, when you are seated.

## Making your own enclosures

If you want to save some money by building your own enclosures, all the necessary dimensions and other information is accessible on the designer's website at [www.stonessoundstudio.com.au](http://www.stonessoundstudio.com.au).

If it was our choice, we would pick the complete kits rather than going to all the trouble to make the cabinets. Sure, you will save some money but there is a great deal of work involved. Consider that the front baffle needs to be laminated from two 18mm sections and you need to make the bass port with its carefully flared ends.

There are really no short cuts to making the cabinets and if you don't follow the diagrams very closely, you will prejudice the sound quality. The above site has all the information on these speakers so if you want to check any aspect of the design, you can readily do so.

sc

### Kit availability

Fountek ribbon speakers, Peerless speakers and all of the kits for the Signature Series are exclusive to Wagner Electronics, 138 Liverpool Road, Ashfield, NSW 2131. Phone 02 9798 9233; fax 02 9798 0017.

Website: [www.wagner.net.au](http://www.wagner.net.au)

#### COMPLETE KITS

Include speakers, cross-overs, all hardware and cabinets. (Price per pair [except 260c] including GST).

#### 260

Plain MDF .....	KIT260-MDF .....	\$1299.00
Black vinyl .....	KIT260-BV .....	\$1399.00

#### 260C (one unit only)

Plain MDF .....	KIT260C-MDF .....	\$649.00
Black vinyl .....	KIT260C-BV .....	\$719.00

#### 360

Plain MDF .....	KIT360-MDF .....	\$1159.00
Black vinyl .....	KIT360-BV .....	\$1299.00

#### SPEAKER KITS (without cabinets)

Include speakers and crossovers but no cabinets and hardware. (Price per pair [except 260C] including GST).

260 Kit .....	SPK260 .....	\$799.00
---------------	--------------	----------

260C kit.....	SPK260C (one driver only).....	\$399.00
---------------	--------------------------------	----------

360 kit.....	SPK360 .....	\$699.00
--------------	--------------	----------