



Product Information Sheet

DAEX25 Sound Exciter Pair



Applications

The 8ohm SoundPAX exciter uses a 25mm VC exciter mounted in a polypropylene enclosure. The enclosure has three flexible legs with double-sided foam adhesive pads allowing the whole exciter assembly to be assembled onto the panel. Thus an exciter can be securely mounted to vertical surfaces in a robust, reliable manner.

Technical Features

- Available in 4, 8,16, and 32 ohm nominal impedance ($\pm 15\%$, manufacturer's specification)
- Basic exciter dimensions : Max OD Φ 93.1mm, Thickness –20.4mm, Weight - 62.9gms.
- Nominal Power rating – 5W rms, Max Power rating – 10W rms (manufacturer's rating according to IEC 268-5)
- Heat resistance – tested at 60°C for 24hrs, Cold resistance – tested at -15°C for 24 hrs (manufacturer's information)
- Humidity resistance - tested at 40°C for 48hrs, 90-95% humidity for 96 hrs (manufacturer's information)

Dynamic Drive Parameters

BI	R_e	$L_e @ 10\text{kHz}$	Expo L_e	Expo R_e	f_{re}	Mms	Mmm
T_m	Ω	μH			kHz	gms	gms
2.999	7.147	77.386	0.831	0.356	13.5	0.77	62.89

Cms	Rms	dDrv
m/N	Ns/m	cm
0.534e-3	0.058	2.5

Impedance measured using Clio and drive parameters calculated using ExcParam (NXT Designer software)

Basic Drawing

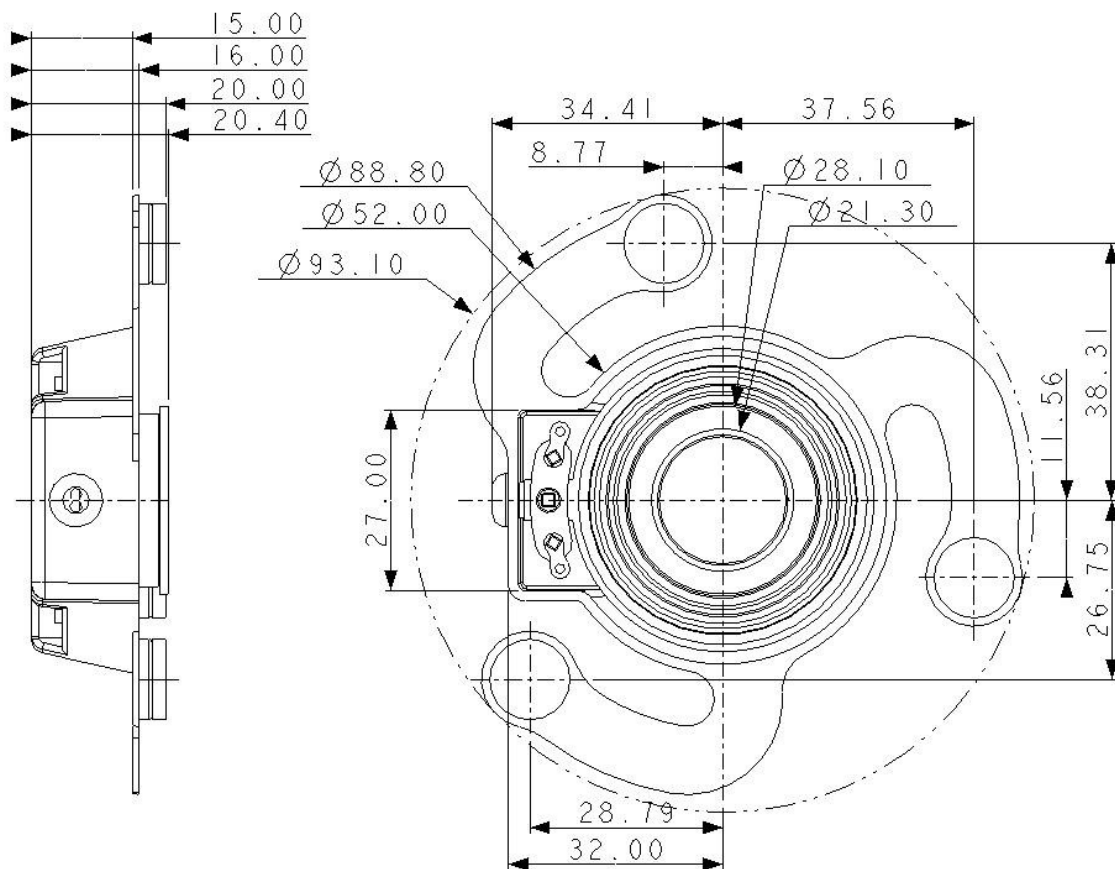

Dayton Audio
Springboro, Ohio, USA
Phone: 937.743.8248
daytonaudio.com



Tech Note: Understanding Exciters – Principles and Applications

daytonaudio.com
Designed and Engineered In USA

Introduction

Typical loudspeakers have been used for nearly a century to add audio reproduction to rooms, displays, exhibits, kiosks, and many other locations where audio is desired. However, certain kinds of applications are inherently hostile to ordinary loudspeaker drivers, and in other applications, visible loudspeakers or loudspeaker grilles are undesirable or unacceptable. In these applications, surface exciter technology may be used to introduce quality audio playback via completely hidden and protected means. Surface exciter technology relies on devices called “exciters” to conduct vibrating energy into solid surfaces, allowing them to radiate sound as though they were a speaker. Surface exciter technology is highly versatile, and can be used in many places where loudspeakers cannot go, where they may be vandalized or damaged, or where the audio system must not be seen.

This article will describe surface exciter technology, the basic functionality of exciters, some guidelines for panel material and placement selection, and how exciters can be used to solve audio reproduction problems that conventional speakers cannot, usually in an extremely simple and cost-effective manner.

How An Exciter Works

The key component of surface exciter technology is the exciter itself. Simply, an exciter functions like a loudspeaker driver where the cone is replaced by a rigid connection to the surface that will radiate the sound. Exciters consist of a motor assembly, a voice coil, a suspension system, electrical connection terminals, and a coupling plate or ring that joins the voice coil to the mounting surface. Unlike a loudspeaker that uses a frame and a cone diaphragm to couple vibrations to the surrounding air, the exciter uses the inertia of its own physical mass to apply force from the voice coil to the mounting surface, which is usually flexible enough to be set in motion to produce sound.



The exciter works by exciting a typically planar surface at a single point. Unlike a loudspeaker driver, where the cone moves essentially in unison with the voice coil, most surfaces are not rigid enough to conduct the exciter’s force evenly across their entire surface area, so they often vibrate in a chaotic manner as longitudinal sound waves travel through the surface itself. This enables a large panel to have the wide dispersion of a much smaller loudspeaker cone, even though the entire panel is set in motion. The panel material behaves like its own acoustic environment, with its own speed of sound, so achieving the most balanced and pleasing sound possible requires careful placement of the exciters themselves on the surface. The material type, exciter placement, and edge termination of the surface all affect the sound properties of a surface, though exciters can give acceptable results when mounted on nearly any kind of surface.

Exciter Selection and Types



Bone Conducting Exciters (BCE) and Coin Type Exciters (CT)

Dayton Audio Bone Conducting Exciters (BCE) produce sound through direct vibration of the bones in the head, creating sound using bone conduction. They are also capable of providing low-level excitation to surfaces, creating small invisible speakers or implementing 'haptic' tactile feedback where high acoustic output is not needed. Bone Conducting exciters are excellent for unique OEM sound applications and for the experimenter, where conventional speakers and exciters cannot be used due to size constraints.

Thin, small, and multi-purpose, Dayton Audio Coin Type Exciters (CT) use high grade neo magnets to create maximum magnetic flux around proprietary voice coil structures. Available in compact sizes, they are the ideal selection when limited space and smaller surface areas are available for the sound application. Most Dayton Audio CT exciters include a high strength peel-and-stick film adhesive which makes mounting them quick and easy while providing the bonding necessary for the highest levels of acoustic transfer between the transducer and the surface to which it is attached.



Extended Mount Exciters (EM, FP, TP, Q)

Dayton Audio Extended Mount Exciters (EM) incorporate extended legs and rugged plastic housings. The additional stabilizing legs with mounting tabs allow for more robust mounting and higher power handling capabilities. Leg and tab extensions on the exciter allow it to be firmly placed on almost any substrate to produce excellent sound. Extended Mount exciter mounting designs allow for a strong, customized hold to virtually any surface. Ideal for commercial or visually exposed applications, Extended Mount exciters are available in multiple performance and size variations. A high strength peel-and-stick adhesive is used for quick assembly and firm coupling to any surface for maximized acoustic energy transfer. Tripod (TP) and Quad Arm (Q) exciters feature three or four extended legs to stabilize the exciter and support its weight, and Flat Pack (FP) exciters feature a shallow design with minimal footprint and screw tab or adhesive mounting.



Specialty and High Power Exciters (VT, FHE, SHF, EP, UT, W)

Dayton Audio Specialty and High Power Exciters are available for applications requiring higher power handling and increased sound performance. Specialty and High Power exciters are perfect for use in commercial applications, thanks to extreme life testing and enhanced audio performance capabilities. These exciters incorporate specialized mounting provisions along with high strength peel-and-stick adhesives. In applications where the exciter placement may be exposed to water, weather, or dust, Ingress Protection (IP) rated exciters are available.

Material Selection for Exciters

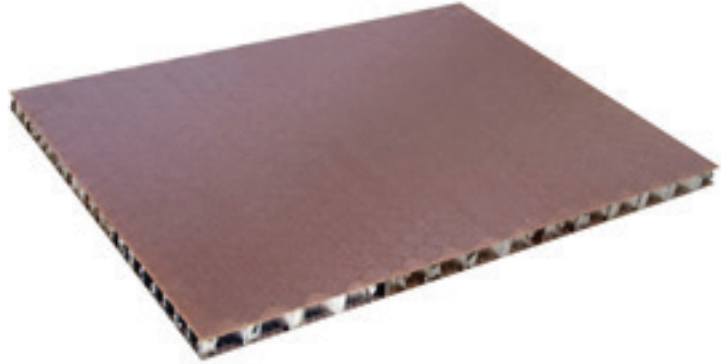

In many surface exciter applications, the material of the surface to be excited and the edge termination of the surface are dictated by external factors. However, these selections can be optimized to provide improved audio quality over a wider bandwidth from the hidden 'speaker' formed by the exciter and the panel. The material that the exciter is used with has the greatest impact on the frequency range and efficiency of the exciter, which is why a generalized frequency or impedance response curve is not typically published for exciters.

The ideal material for mounting an exciter is a thin, lightweight sheet of material with high compressive strength and moderate to high bending strength. The compressive strength of the material has the greatest effect on the treble extension of the resulting 'speaker' (affecting 'detail' and 'air'), while the bending strength of the material influences the midrange and low frequency efficiency of the 'speaker'.

The amount of acoustic output from the panel over its effective bandwidth is determined by the weight of the panel material and the available force from the exciter. For thicker or heavier materials, a larger and more powerful exciter may be needed, or multiple exciters may be used. Whenever possible, the weight of the surface to be excited should be minimized.

Excellent materials to use for exciter mounting include:

- Aluminum, Nomex/Kevlar, or resin-impregnated paper honeycomb sandwich composites
- Structural or syntactic foam sandwich composites (e.g. Rohacell)
- Fabric-reinforced phenolic plastic panels
- Fiberglass-reinforced resin panels
- Corrugated or honeycomb cardboard sheet
- Corrugated plastic 'signboard' material
- Foam-core poster board with paper backing

Other materials which are less ideal but still workable include:

- Unreinforced plastic panels
- Mylar sheet
- Plexiglas or Lexan sheet
- Glass windows
- Mirrors
- Acoustic drop-ceiling tiles
- Wallboard
- Plywood/MDF/OSB sheets

Materials which may not give desirable results:

- Metal panels
- Metal structural members
- Concrete
- Wooden beams
- Soil

Exciter Placement and Installation



Once the mounting surface material, shape, and size are known, the exciters can be placed. Exciter placement is critical to achieving uniform excitation of the surface while maintaining wide dispersion. For the best results, exciters should be placed near the center of the mounting surface, but should be offset from each edge of the surface so that the distance from the exciter to the edge is not an even multiple of the distance from the exciter to another edge of the panel, in order to avoid the buildup of standing waves.

For mounting exciters to a flat rectangular panel (a common application), the width of the panel should be less than $4/5$ of the height, or vice versa, and good results will be given with the exciter mounted a distance of $2/5$ of the panel width from one side of the panel, and $3/5$ from the other side of the panel, with the same relationship used for exciter placement with respect to the panel height. This relationship will provide a satisfactory offset to reduce the buildup of standing waves on the panel.

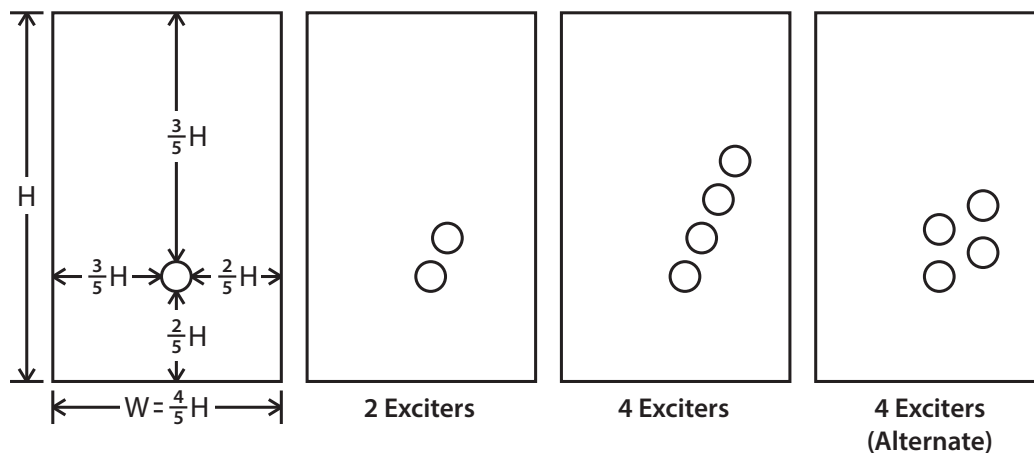

If multiple exciters are needed for a panel or surface, it is not recommended to space the exciters evenly across the surface. This will result in very narrow sound dispersion at upper midrange and treble frequencies. Instead, place the exciters together in a group, with exciters at unequal distances from the panel edges and from one another.

Installation of most exciters is simple. An adhesive pad is provided with some exciters, which should be applied to a smooth, clean area of the surface. For other exciters that provide screw mounting via a mounting plate, it is still recommended to apply an adhesive such as "super glue", hot melt glue, or double-sided tape to the mating surface of the mounting plate in addition to the mechanical fasteners, to avoid rattling or buzzing of the mounting plate against the surface. If attenuation of upper frequencies is desired (typically not desirable), this can be achieved with an inductor electrically in series with the exciter, or by adding a compliant pad (such as a sheet of rubber) between the exciter and the surface.

Edge Termination and Damping

As described earlier, prior to being radiated into the room by the vibrating panel surface, acoustic waves first travel through the material of the panel itself, as though it were its own acoustic environment, with its own speed of sound. When these traveling waves in the panel material encounter a different acoustic impedance (such as a different material or a panel edge), some or all of the traveling wave is reflected and propagates in a new direction across the panel. In some instances it may be desirable to reduce this reflected energy to improve clarity and transient response, and this can be achieved through controlled termination of the panel edge, or by applying a soft damping material to the panel itself.

Different types of edge terminations include:

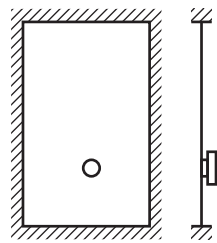

**RIGIDLY SUSPENDED
PANEL EDGES**

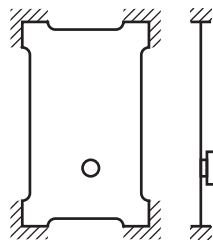

**RIGIDLY SUSPENDED
CORNERS WITH FREE EDGES**

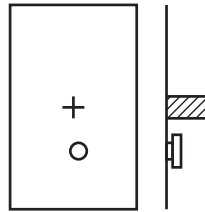

**SUSPENDED RIGIDLY AT
A CENTRAL LOCATION WITH
FREE EDGES**

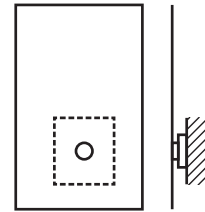

**COMPLIANT SUSPENSION AT
A CENTRAL LOCATION WITH
FREE EDGES**

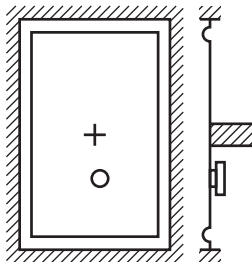

**SUSPENDED RIGIDLY AT A CENTRAL
LOCATION WITH COMPLIANTLY
SUSPENDED EDGES**

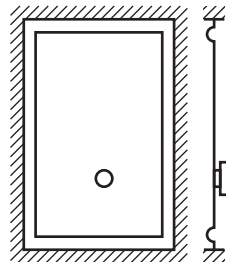

**COMPLIANTLY SUSPENDED
PANEL EDGES**

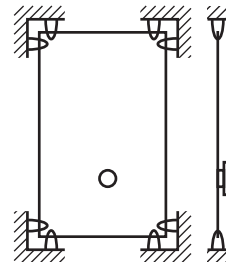

**COMPLIANTLY SUSPENDED
CORNERS WITH FREE EDGES**

The benefit of compliantly suspending part or all of the panel is a reduction in the internally reflected energy, because some of the energy is transmitted into the compliant material and does not get reflected. Compliant suspension of the panel edges may be accomplished using a soft material like foam tape, a silicone adhesive bead, or a flexible rubber member.

Other means can be used to control the vibration of the panel. For example, the corners of a rectangular or polygonal panel may be rounded to help reduce long-decay reflections. Linear or curved braces, point masses, and damping elements (such as felt buttons) may also be added to the panel to control its vibration, but these are generally not necessary except in highly-optimized applications. Engineering modeling software can aid in the application of these more advanced panel damping features, or the placement and use of these items can be determined experimentally.

Additional Tips

- Using a larger panel or installing the exciter to a larger surface will provide deeper bass response.
- A non-magnetic material should be chosen for the exciter mounting surface; mounting the exciter to a magnetic material may interfere with the magnetic circuit of the exciter's motor assembly and impair performance.
- Suspending a panel at a central location will reduce bass response; exciter placement should be chosen to be between central mounting points and panel edges, instead of placing the exciter close to the central mounting point.
- Exciters are slightly less efficient than conventional loudspeakers. As a very rough guideline, expect to replace one speaker with two exciters in retrofit applications.

Wiring of Exciters

Exciters may be used with any typical audio amplifier, using typical speaker wire. However, care should be taken to avoid overloading the amplifier with a low-impedance load. Because many exciter-based audio systems use multiple exciters, care should be exercised in wiring the exciters so the resulting load presented to the amplifier does not fall outside the amplifier's minimum rated impedance.

When using multiple exciters, the units may be wired together in series or parallel to give an acceptable impedance load for the amplifier. When exciters are wired in series, their impedances add together (8 ohms + 8 ohms = 16 ohms). When exciters are wired in parallel, the impedance of one exciter is divided by the number of exciters (8 ohms / 2 exciters = 4 ohms). By creating groups of exciters wired in series, then wiring the multiple series groups in parallel, a wide range of impedances can be created from groups of many exciters. It is usually easiest to use this technique on even-numbered groups of exciters.

Below are some examples of series-parallel wiring to achieve desired impedances.

Example 1: Four 8-ohm exciters, wired for 8 ohms combined

Series Group 1: (8 ohms + 8 ohms = 16 ohms)
 Series Group 2: (8 ohms + 8 ohms = 16 ohms)
 16 ohms per series group / 2 series groups = **8 ohms total**

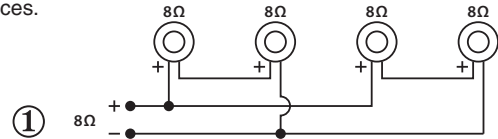

Example 2: Eight 8-ohm exciters, wired for 4 ohms combined

Series group 1: (8 ohms + 8 ohms = 16 ohms)
 Series group 2: (8 ohms + 8 ohms = 16 ohms)
 Series group 3: (8 ohms + 8 ohms = 16 ohms)
 Series group 4: (8 ohms + 8 ohms = 16 ohms)
 16 ohms per series group / 4 series groups = **4 ohms total**

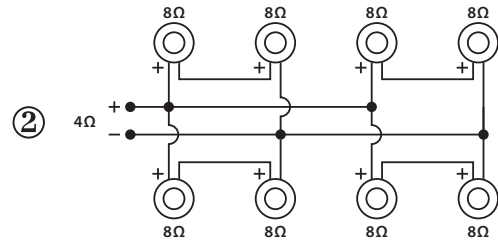

Note: Eight exciters with a nominal impedance of 8 ohms each cannot be wired via series/parallel for 8 ohms. See example 4 for a configuration using nine exciters with a nominal impedance of 8 ohms to achieve an 8 ohm final impedance.

Example 3: Eight 4-ohm exciters, wired for 8 ohms combined

Series group 1: (4 ohms + 4 ohms + 4 ohms + 4 ohms = 16 ohms)
 Series group 2: (4 ohms + 4 ohms + 4 ohms + 4 ohms = 16 ohms)
 16 ohms per series group / 2 series groups = 8 ohms total

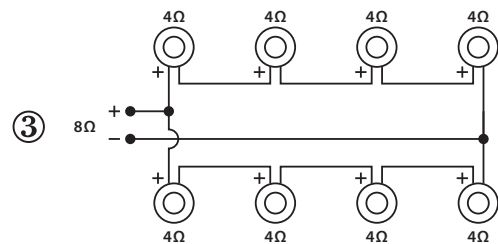

Example 4: Nine 8-ohm exciters, wired for 8 ohms combined

Series group 1: (8 ohms + 8 ohms = 24 ohms)
 Series group 2: (8 ohms + 8 ohms = 24 ohms)
 Series group 3: (8 ohms + 8 ohms = 24 ohms)
 24 ohms per series group / 3 series groups = 8 ohms total

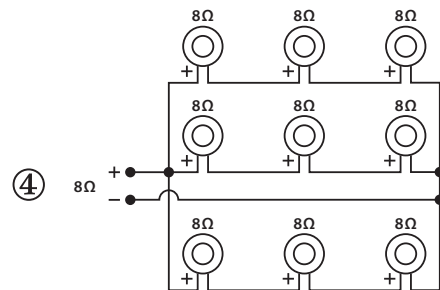

For installations of multiple exciters, the connecting wire should not rest against the excited surface, in order to prevent noise from the wire buzzing against the surface. Where wire contacts the excited surface, it may be useful to add foam or felt to cushion the wire and prevent noise.

Recommended Exciter Applications

Surface exciter technology easily solves many problems in achieving high-quality audio reproduction anywhere it is desired. Exciters are of particular value for installations where loudspeakers may be damaged by weather or vandalized, or where the audio system must not be seen. Additionally, surface exciters may be used to provide a seamless, luxurious interior trim finish in high-design environments where a loudspeaker grille would be an unwelcome discontinuity.

Common applications for exciters include:

- Invisible home theater and multi-room audio
- Audio systems on board airplanes and transit buses
- Electronic gaming machines
- Point-of-purchase product displays
- Commercial distributed audio
- Hidden audio entertainment systems aboard luxury jets and yachts
- Automotive audio systems
- Bathroom tubs and shower enclosures
- Advertising signage
- Multimedia exhibits
- Kiosks

Exciter Quick FAQ:

Here are answers to some common questions regarding the use and application of exciters for audio:

1) Why select an exciter over a small speaker or conventional transducer?

Exciters work by vibrating the surface they are mounted to, creating a high-quality invisible speaker. Because the substrate/surface is being vibrated to produce the sound, there is no need for grills or openings in the surface, making the system more resistant to vandalism or weather ingress. The exciter's thin profile makes it perfectly suited for applications where there are space and depth limitations. In addition, the wide-angle sound dispersion from an exciter often exceeds standard loudspeaker performance.

2) Can two exciters on a single panel create stereo sound?

Yes! It is possible to use a left channel and right channel exciter on a single panel to achieve stereo sound. The quality of the stereo image will be determined by the distance between the left and right channel exciters, and the symmetry of their placement on the panel, just like the distance between conventional loudspeakers affects their stereo image. Groups of exciters can also be used for the left and right channels, following the placement recommendations in this article.

3) How can I increase the low frequency (bass) sound being produced by the exciter?

Bass and low frequency sound are enhanced greatly when using larger panels or increased areas of substrate. Additionally, using a heavier substrate will allow deeper bass to be achieved, but at the expense of reduced treble output.

4) Will the vibrations from an exciter be visible or “shake” the device or substrate the exciter is mounted to?

Because the vibrations are small and “fast”, and propagate over a larger panel area than a typical speaker, the movement of the surface is usually not visible to the listener. As an example, should the exciter be used on video displays, the visual impact of sound being generated from the panel is unseen. Also, most electronic devices will be unaffected by the vibration of an exciter.

5) How are exciters mounted or affixed to surfaces?

Most exciters incorporate a mounting ring with peel-and-stick film adhesive that is used to mount the exciter to most any substrate or surface area. Prior to mounting, surfaces should always be prepared (clean and dry) to remove dust, oils or any other elements that may impede the bonding of the adhesive and surface areas.

6) Does placement impact the sound performance of the exciter?

Placement does impact the sound being produced by the exciters, and therefore prior to selecting a permanent location listening tests and audio testing is recommended. Exciter placement is covered in detail by this article, but in brief, exciters that are offset to the side (not centered) on a panel provide the best sound experience. However, this may not always be the case as sound quality is subjective and can be perceived differently from listener to listener.

7) Can I attach exciters to ordinary surfaces (walls, ceilings, doors)?

Yes! Exciters can turn ordinary surfaces into high-quality speakers, and exciters can often be hidden behind or inside panels to provide sound from an invisible source. Unlike in-wall speakers, which interface directly with the air and require visible grilles to protect the drivers, an exciter sets the wall surface itself into motion to produce sound, so no grille is required. The surfaces that will give the best performance are those which are thin and light, like cabinet doors in a kitchen, or a fiberglass shower enclosure.

8) How does an exciter differ from a “bass shaker” device?

Exciters differ from “bass shakers” in two important ways. Normally, a bass shaker device will have an internal mass element inside a housing, and the reaction force from vibrating the mass creates the low-frequency bass vibrations. In an exciter, the mass of the motor structure remains stationary by its own inertia, and vibrating energy is transferred directly to the surface by the voice coil. Also, the design of a bass shaker is usually limited to low frequencies because of the large mass involved, while an exciter can produce the full range of sound because the moving mass is low. Choosing an exciter with a suspension system that is more “stiff” can increase the sound efficiency of the exciter and panel, while limiting low frequencies.

OEM Inquiries

If you are an OEM looking for a custom audio solution, Dayton Audio has the expertise and experience to create a custom exciter-based solution that is perfect for your application, project, or product development. Contact us today at info@daytonaudio.com to get started.

Notice

The information contained in this Tech Note is intended to be used for general knowledge and information purposes only. Should you have any questions about the information found in this document, please contact Dayton Audio or an Authorized Distribution Partner.



Dayton Audio • 705 Pleasant Valley Dr. Springboro, OH 45066 • (937) 743 8248 • info@daytonaudio.com



Sound Exciters Installation Instructions

1. Connect the Sound Exciters to the amplifier with the supplied wire
2. Turn the amplifier on and set the volume to a reasonable level
3. Press the Sound Exciter against the intended surface
4. Move the Sound Exciter across the surface until the ideal tone is achieved
5. Peel the backing from the adhesive pads and permanently place the Sound Exciter

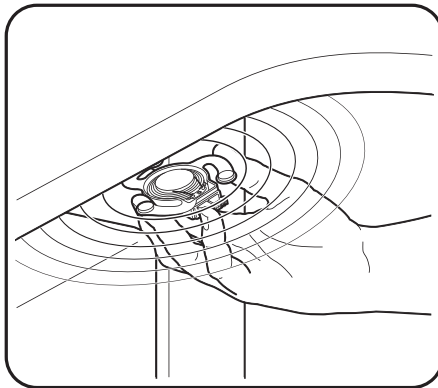

NOTE: Before permanently attaching the Sound Exciters, test the placement for optimal sound reproduction.

Specifications:

- Ideal for use with 10~50 Watt Amplifiers
- Wide Frequency Range
- 8 Ohm Impedance
- 6 Watt Power Capacity