

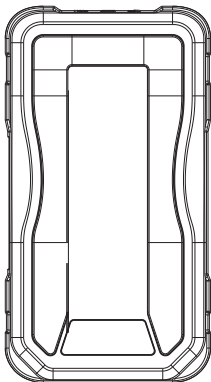

GTRAKPRO

VEHICLE TRACKING SYSTEM

Startup Guide



gatortracking.com.au

(Version 2.0)

1 Inclusions

- Main device
- Power cord
- 4-pin relay
- Microphone
- SOS cable

1.1 Optional accessories

- 5-pin relay*2 (Optional refer Diagram on p7 3.3)

This is a standard automotive relay available from aftermarket retailers

1.2 Features

- Real-time GPS+AGPS tracking
- Track by time interval/distance/direction change
- Track through SMS or Web
- Remote fuel/power cut-off control via SMS or Server
- Voice monitor
- SOS alarm
- Geo-fence alarm
- Vibration alarm
- Movement alarm
- External power cut-off alarm
- Door status-detection
- Analog & Digital inputs
- Low battery alert

1.3 Specifications

Frequency	3G 850/900/1900/2100MHz
	Quad Band, All network support
Networks	WCDMA(3G)
Operating Voltage	9-36VDC<300mA
Location Time	Cold Start: < 35s
	Hot Start : < 2s
Location Accuracy	<10 meters
Operating Temperature	-20°C ~ +70°C
Dimension	98.5(L) x 52(W) x 15(H) mm
Weight	80g

2. My device

2.1 Appearance

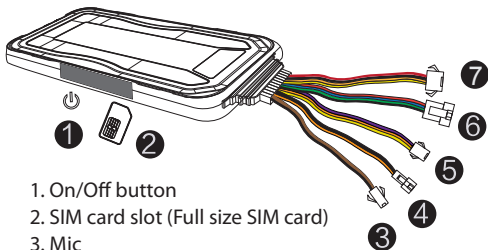

1. On/Off button
2. SIM card slot (Full size SIM card)
3. Mic
4. SOS button
5. Extension interface
6. Data
7. Power, Oil/Electricity, ACC

2.2 LED indicators

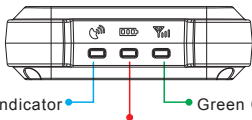

Blue GPS LED indicator

Green GSM LED indicator

Red Power status

GPS LED Indicator - Blue

● → ○	0.1s ON & 0.1s OFF	Searching GPS signal
●	Steady on	GPS is fixed
○	OFF	No GPS fixed or initialising

GSM LED Indicator - Green

● → ○	0.1s ON & 0.1s OFF	GSM initialising
● → ○ ○ ○	0.1s ON & 1.9s OFF	Receiving GSM signal
●	Steady on	As above + connected to APN
○	OFF	No GSM signal or SIM error

Power Status - Red

● → ○	0.1s ON & 0.1s OFF	Low battery
● ● → ○ ○ ○	2s ON & 2s OFF	Full charged
● → ○ ○ ○	0.1s ON & 1.9s OFF	Normal operating
●	Steady on	Device is charging
○	OFF	Low battery/Power off

● → ● → ●	Flash in a loop	Device is in defense status
-----------	-----------------	-----------------------------

3. Installation

3.1 Installing the SIM card

The SIM card should be inserted in the correct orientation. Note the diagram on the rubber cover indicating the side the SIM cards notch should face. Full size SIM card is required but not supplied.

Open the cover

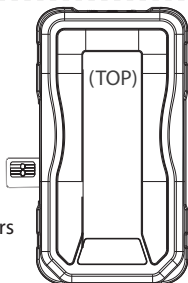
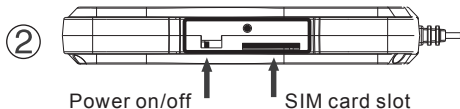

Turn the battery switch to the on position after it is wired to the vehicle. Make sure the device is turned off before installing or removing the SIM card

3.2 Device Wiring Definition

Picture 1

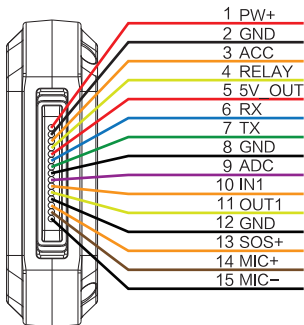
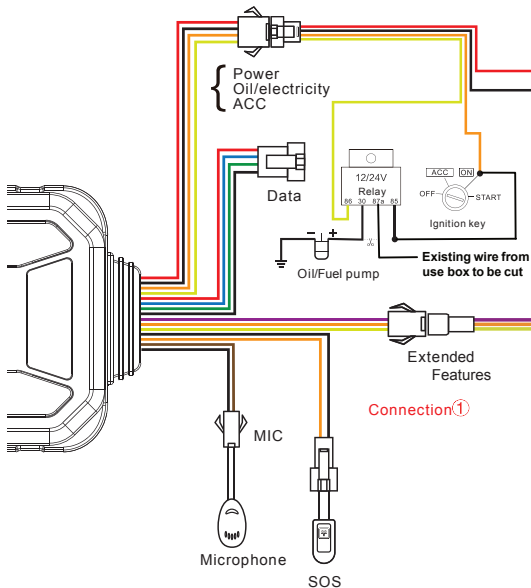

Table 1

Line	Colour	Description	Definition
1	Red	PW+	12V/24V car battery positive
2	Black	GND	12V/24V car battery negative
3	Orange	ACC	ACC ignition
4	Yellow	RELAY	Relay control
5	Red	5V-OUT	External power supply
6	Blue	RX	Data RX / backup interface
7	Green	TX	Data TX / backup interface
8	Black	GND	Data Ground Output
9	Purple	ADC	Extended Features
10	Orange	In1	
11	Yellow	OUT1	
12	Black	GND	SOS button
13	Orange	SOS+	
14	Brown	MIC+	Microphone
15	Black	MIC-	

3.3 Device Wiring Diagram



Notice: The purple line (ADC) of terminal connects to analog signals line, like analog temperature sensor or fuel sensor. Voltage detected by analog signal ranges from 0~30 Vdc.

3.3 Device Wiring Diagram Cont...

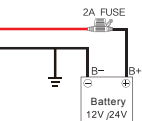

Analog signal

Diagram 1

Negative trigger connection car type

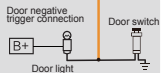

Positive trigger connection car type



Diagram 2

Output control Connection 2

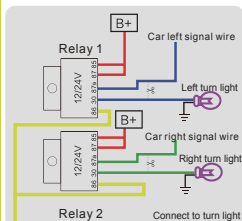
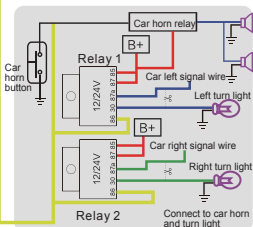

Diagram 3



3.4 Wiring Instruction

1. The standard power supply ranges from 9V to 36VDC. Please use the power wires supplied as part of this loom. Red line means positive side while black line means negative side.
2. ACC line (orange) connects to the vehicle's ACC switch, detecting ignition on and off.
3. Device's oil and electricity control line (yellow) connects to relay's 86. (thin yellow line of relay socket) Make sure that all wiring from Power sources are through a fusible link.

Fuel cutoff relay wiring instructions

If there is an electric fuel pump in the vehicle. Locate the Positive wire leading to the pump. The Fuel pumps power supply can be found at the main fues box. Once you have located the fuse. you can remove it to check if you have found the correct power source. when the fuse is removed the engine should stop shortly after (this is what the relay does). Cut the positive line going from the fuse box to the pump and wire it via the relay as shown in the diagram 3.3 page 7. Alternatively you can cut the ignition wiring. Again you can find the correct power wire by removing the fuse and testing if the car is disabled. **This kind of installation is best left to advanced Installers or Auto electricians.**

Note:

A 12V relay is included in the kit. If the vehicle has a 24V system, then a 24V relay is needed.

4. To monitor analog signals, the purple line (ADC) of extended features port should be connected to the analog line.

5. To check status of car door, orange line (IN1) should be connected between the door light and door switch (See diagram 3).

6. To find car remotely, please connect the yellow line (OUT1) of extended feature port to external relays as illustrated in diagram 3 page 8.

3.5 Device Installation

Under front windshield underneath the dash

Rear windshield under rear parcel shelf

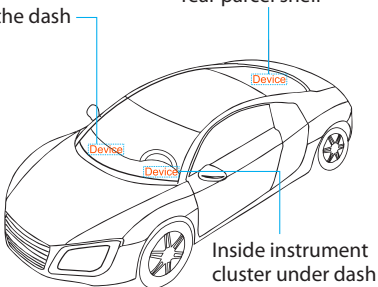

Inside instrument cluster under dash

Note:

There are many areas you can hide the tracker in your vehicle. The device should face up to the sky. Metal thermal barriers / heat shielding layers of the windshield can affect the performance. Please keep this in mind when looking for a suitable location

4. Operation of device

Power on/ Power off

Power on: Once you insert a valid SIM card and connect all the wires, turn on the device by turning on the cars ignition. The Red Power LED will flash first. During the signal searching process, The Green GSM LED and Blue GPS LED will flash once. When the Blue GPS LED stays ON

this means the device has been located and it starts to work. On first turn on this may take a minute or two. The Green LED should stop flashing within 30 seconds.

Power off: Move the power switch to the OFF position.

Reminder:

When the device is installed in a vehicle and is connected to the vehicles power source, don't forget to turn on the Battery switch under the side cover. If the battery is **OFF**, it can not be charged or used as a back up in the event that the wiring is tampered with.

5. Main Functions

5.1 SOS

In an emergency, press the SOS button for 3 seconds to activate the SOS alarm. The device will send an SOS SMS to the preset SOS number. The Alarm message will also be sent to the server platform where an email and or system message is activated. (See command list 7-8) (Note: The Direct SMS ability is dependant on the SIM card having SMS capability)

5.2 Power cut-off alarm

When the electricity supply of the device is cut, the device will activate the power cut-off alarm.

5.3 Low battery alarm

When the internal battery is low, the device will activate the low battery alarm.

5.4 Vibration alarm (default OFF)

When the vehicle is shaken or hit several times, the vibration alarm is triggered.

(See command list 7-12)

5.5 Voice monitoring

Using the pre-set SOS number to dial the device, after 10 seconds, the device changes to monitoring mode. In this mode the caller can then hear sounds inside the vehicle.

Note:

1. A Pre-set SOS number is necessary for this function.
2. The SIM card of the calling device must have caller ID service active
3. The SIM card Must have Voice call capability.
4. When in this mode, the device is not trackable.

5.6 Displacement alarm(default OFF)

The device will send a movement alarm when the vehicle moves out of the pre-set distance (when ACC is off and GPS is fixed).

5.7 Oil-fuel/electrical contact CUT OFF

If the Vehicle is stolen, a fuel/electrical cut-off command can be sent by the server platform, or via SMS.

Note:

1. Make sure the ACC is correctly connected.
2. When the ACC is OFF, the command will be executed immediately.
3. When The ACC is ON, but the GPS does not have a fix, the command will be postponed until a GPS fix is available.
4. When The ACC is ON and the GPS has a fix, the command will be executed when the vehicle speed is less than 20km/h.

To use this function Via SMS you have to set a "Center number" first. Only the "center number" can send the cut off/restore oil/fuel command to the device. (See command list 7-14)

Note:

1. Only the SOS number can be used to set the center number.
2. Only the SOS number can be used to delete the center number.
3. There is only one centre number that can be set.
4. Note the Spelling is center not re

5.8 Restore oil-fuel/electrical contact

You can send a restore command via the server platform or via SMS and restore the vehicles power. (See command list 7-15)

5.9 Restart device

If GPRS is abnormal (device is offline), you can send SMS a command **RESET#** to restart the device. The device will reboot after 20 seconds after receiving the command.(See command list 7-16)

5.10 Door detection

This device is able to detect a door open/closed status. (if the IN1 wire input is connected to the door switch during installation) the tracker uploads the cars door status to the server platform. Negative triggering is default. When the car door's status is negative triggering, in this case there is no need to change any settings. If the car door status (open) is positive triggering, the trigger polarity must be modified as follows by sending command: **DOOR,1#** via SMS). See diagram 2 (3.3) for wiring instructions. (See also command list 7-17)

Note:

Negative triggering (default): Means when the door is opened, the signal on the switch wire is Ground (0v); When the door is closed, the signal level is a voltage. Some cars/trucks with computerised interior lighting systems may not be compatible or may require a pull up resistor installed.

5.11 Analog signal

The Tracker can measure the car battery's voltage or any other variable voltage and upload it to the server platform. Purple wire (ADC). You can set up analog temperature sensors, fuel sensors etc. The Voltage range of the analog input is 0~30Vdc. See diagram (3.3) for wiring instructions. (See command list 7-18)

5.12 Find the car by triggering the indicators and or horn/buzzer

When Wired to do so, you can send a command that instructs the device to flash the indicators or toot the horn of the vehicle. See diagram 3(3.3) for wiring instructions. (See command list 7-19)

6.Web Platform Operation

This device is factory configured to connect to the Gator GPS tracking server platform and it is designed to detect the network and set the APN automatically. In most circumstances there is NO programming required to connect to our server. However, in the event that you wish to use the device on a third party server please use the following guide. (manual APN and manual server settings pg17, 6.1)

You can check to see if the device is ready to connect to the server by observing the green LEDs status before placing the device in its final installed location. the GSM LED Indicator - (Green LED) should be

constantly on within 30 to 40 seconds of its first turn on. If the LED is Solid, your ready to go to the server, set up an account and add this device. If the indicator is flashing you may need to check the APN settings as the tracker may not be able to auto set this parameter.

6.1 Manual APN Setting

Web Search your Sim cards APN by searching "service provider name_APN settings". This should lead you to the APN name that needs to be used to allow your sim card to connect to your providers APN (Correct APN = Gain access to the Internet).

SMS Command **APN**, [apnname]#

Replace [apnname] with your service providers APN name. (See command list 7-6)

Manual Server Setting

If you are using a third party Server (not the Gator server). You can change the server using the following command. Please note for 3rd party web services we can not offer technical assistance on this topic.

SERVER,mode,domainName/IP,port,0#

E.g. SERVER,1,www.othertrackingserver.com,8011,0#

SERVER,0,211.154.135.113,8011,0#

mode = 1 means set with domain name

mode = 0 means set with IP address

6.2 Login Web service platform

1. Go to www.gator.net.au
 2. Set up a user account
 3. Add the device to your account using the IMEI number on the Gift box (also printed on the device)
- Detailed instructions are at gator.net.au (Help)

6.3 Mobile devices

Access using mobile devices is done via the web server portal. However, on Mobile devices the portal is optimised for mobile browsers and works more like an App with advanced settings hidden for simplification. For advanced settings and set up please use a lap top or desk top computer.

7.Common Command List

Send these SMS commands in the right column to the devices SIM card number (Phone number) to achieve the respective functions as per list on Pages 19/20. Do not adjust any settings that you do not understand as this may adversely effect the devices performance

7.Common Command List cont....

Setting

SMS command

	Setting	SMS command
1	Device status	STATUS#
2	Device coordinate	WHERE#
3	Location URL	URL#
4	Check version	VERSION#
5	Network setting	GPRSSET#
6	APN setting	1. APN, [apnname]# E.g: APN,internet# 2. APN, [apnname],[user],[pwd]# E.g: APN,internet,CLIENTE,AMENA#
7	Server setting	SERVER,mode,domain/IP,port,0# E.g. SERVER,1,www.ydpat.com,8011,0# SERVER,0,211.154.135.113,8011,0# mode1 means set with domain name mode 0 means set with IP address
8	SOS setting	1. Add SOS number: SOS,A,number 1,number 2,number 3# 2.Delete subjected sequence of SOS number: SOS,D,number sequence 1, number sequence 2, number sequence 3# E.g. SOS,D,1,2,3# 3. Delete the SOS number SOS,D,phone number# 4. Query SOS number SOS#
9	GPS data upload time interval	TIMER,T1,T2# T1=5 ~ 18000 seconds ; ACC ON upload interval default value 10 T2=5 18000 seconds ACC OFF upload interval default value 10 (when GPS is not sleep)
10	GPS data upload distance interval	DISTANCE,D# D=0、 50~ 10000 meter; Distance interval default value 300, unit meter

7.Common Command List cont....

Setting

SMS command

11	Delayed defense setting	DEFENSE,A# A:1 ~ 60 minutes , set delayed defense, default value 10 minutes
12	Vibration alarm (default OFF)	1. SENALM,ON# 2. SENALM,OFF#
13	Displacement alarm setting (default OFF)	1. MOVING,ON,R,M# R=100~ 1000; Displacement radius unit: meter M=0-2; Alert way 0:GPRS 1: SMS+GPRS 2: GPRS+SMS+CALL E.g. MOVING,ON,200,2# 2. MOVING,OFF#
14	Set centre number	Set center number : CENTER,A,mobile number# Delete center number: CENTER,D#
15	Power/oil control	RELAY,A# A=0/1 0= restore petrol; 1=cut off petrol Default value 0 E.g. RELAY,1#
16	Restart	RESET# Device restart 20 seconds after receiving this command
17	Car door negative/positive triggering setting	DOOR,A# A=0/1; 0 negative triggering, 1 positive triggering default: 0
18	Analog upload setting	Upload analog data: ADT,ON,T# T: upload interval; scope: 5 3 600(second) Turn off analog upload: ADT,OFF# default: OFF
19	Find car by triggering light and buzzer	FIND#

8.Trouble shooting

If you are having trouble with your device, try these troubleshooting procedures before contacting a service professional.

Problems	Causes	Solutions
Poor signal	Signals are blocked due to the vehicle being located underground or in a sheltered building. or due to the devices location inside the vehicle being sheilded by metallic parts.	
Unable to connect to Server	Incorrect APN	Refer pg17 (6.1) for manual setting
No power off alarm	Built-in battery is off	Turn it on
Fail to start the car	Power cutoff / ACC abnormal	Restore power/Check ACC
No update of vehicle's location	No GPS positioning	Test the device again/ Change installation position

9. IMEI/SIM number safeguard

Copy the IMEI/I.D. number (10-digit bar code of the device), and the SIM card number and place here for safe keeping before installing the device.

NOTE: DO NOT LEAVE THIS INFORMATION INSIDE THE VEHICLE (for security reasons)

IMEI number

— — — — —

SIM number

Retailer

Date of purchase

10. Technical assistance

If you need assistance setting up or using your Gator product now or in the future, call Gator Support Australia.

TEL: 03 – 8587 8898

FAX: 03 – 8587 8866

Mon-Fri 9am – 5pm AEST



Please retain this user guide for future reference. If you would like to download a digital copy of this manual, or other Gator manuals/software, please visit the website gatortracking.com.au.

This manual is considered correct at time of printing but is subject to change. For latest manuals and updates refer to the website.

Copyright © 2019 by TDJ Australia All rights reserved.

No part of this publication may be reproduced, distributed, or transmitted in any form or by any means, including photocopying, recording, copying or other electronic or mechanical methods, without the prior written permission of the author.

