



DesignMax DM10P-SUB

pendant subwoofer

Product Overview

Delivering rich low-end performance, the DesignMax subwoofers bring instantly impressive bass to any commercial sound installation. The 300-watt DM10P-SUB is a 10-inch pendant subwoofer with a 40 Hz - 125 Hz frequency range and features a recessed single-point suspension system for a sleek, attractive appearance. All models are available in black or white.



Key Features

Complete any commercial sound installation with 16 DesignMax loudspeakers to mix and match, including in-ceiling, surface-mount, and pendant form factors, subwoofers, high-SPL compression-driver models, compact low-profile models, and outdoor-rated options

Choose from three DesignMax subwoofer models — the 180-watt in-ceiling DM8C-SUB, the 300-watt surface-mounted DM10S-SUB, and the sleek 300-watt DM10P-SUB pendant subwoofer

Deliver rich bass performance with custom drivers; for optimal performance, use select Bose Professional DSPs and amplifiers to enable Bose Professional loudspeaker EQ and SmartBass processing, which expands performance and response at any listening level

Blend with any room design with elegant form factors, minimum-bezel grilles available in black or white, and removable logos

Install easily with industry-standard accessories — all models include Euroblock connectors; in-ceiling models include plenum-rated backcans, tile bridges, and front-access audio wiring that makes installation and troubleshooting easier

Provide an open, attractive aesthetic with pendant loudspeakers featuring a recessed single-point suspension system that keeps hardware out of sight and can be used to hold and hide a service loop for easy access

Technical Specifications

SINGLE-LOUDSPEAKER PERFORMANCE		
Frequency Response (-3 dB) ¹	46 - 108 Hz	
Frequency Range (-10 dB) ¹	40 - 125 Hz	
Nominal Coverage Angle	Omnidirectional below 200 Hz	
	AES transducer test ⁴	Bose Professional extended-lifecycle test ⁵
Power Handling, long-term continuous	300 W	250 W
Power Handling, peak	1200 W	1000 W
Sensitivity (SPL / 1 W @ 1 m) ²	85 dB	85 dB
Calculated Maximum SPL @ 1 m ³	110 dB	109 dB
Calculated Maximum SPL @ 1 m, peak	116 dB	115 dB
Recommended Crossover	80 - 200 Hz (requires active crossover in DSP)	
Loudspeaker EQ	Not required, Bose Professional EQ voicing, and SmartBass processing available	
Recommended High-pass Protection	45 Hz with recommended 24 dB/octave filter	
Transformer taps	70V: 20, 40, 80, 150 W, bypass	
	100V: 40, 80, 150 W, bypass	

TECHNICAL DATA

DesignMax DM10P-SUB

pendant subwoofer

TRANSDUCERS	
Low Frequency	1 × 10-inch woofer (254 mm)
Nominal Impedance	8 Ω (transformer bypass)
PHYSICAL	
Enclosure Material	Engineered plastics
Grille	Perforated steel, powder-coated finish
Logo	Rotatable, removable
Color	Black: RAL 9005, paintable
	White: RAL 9003, paintable
Paintable	Choose a paint that is specifically designed for use with polypropylene (PP) plastics.
Environmental	Indoor only
Safety Agency	UL-1480A, S5591/UL Listed, NFPA70 & NFPA90-A, CE compliant, UL 2239 for suspension cable
Operating Temperature Range	0 °C to 50 °C (52 °F to 122 °F)
Connectors	Euroblock 6-pin connector with loop-through, mounted on top. Accepts 18 AWG (0.8 mm ²) to 14 AWG (2.5 mm ²) size wire.
Suspension / Mounting	Each DM10P-SUB has one (1) suspension attachment point and one (1) safety cable attachment point. Included is one (1) 4.5 meter (15 foot) Gripple adjustable suspension cable.
Product Dimensions (Enclosure Diameter × Depth)	400 × 383 mm (15.7 × 15.1 in)
Cable Dimensions	Length: 4.57 m (15.00 ft)
	Diameter: 3.2 mm (0.125 in)
Net Weight	8.9 kg (19.7 lb)
Shipping Weight	12.65 kg (27.89 lb)
Included Accessories	Each DM10P-SUB includes one (1) Gripple adjustable suspension cable system, four (4) cable ties
Optional Accessories	Threaded Rod Adapter, Conduit Adapter
PRODUCT CODES	
835265-0110	DESIGNMAX DM10P-SUB SINGLE BLACK
835265-0210	DESIGNMAX DM10P-SUB SINGLE WHITE
850571-0010	DESIGNMAX PENDANT THREADED ROD ADAPTER, PAIR
854381-0010	DESIGNMAX PENDANT CONDUIT ADAPTER, PAIR

Footnotes

1. Frequency response and range measured on-axis in whole-space environment with recommended EQ
2. Sensitivity measured on-axis in whole-space environment averaged 100 Hz - 10 kHz using recommended high-pass protection
3. Maximum SPL calculated from sensitivity and power handling specifications, exclusive of power compression
4. AES standard 2-hour duration with IEC system noise
5. Bose Professional extended-lifecycle test using pink noise filtered to meet IEC268-5, 6-dB crest factor, 500-hour duration
6. Frequency response shown using 45 Hz HPF 24 dB/octave and 100 Hz LPF 24 dB/octave

TECHNICAL DATA

DesignMax DM10P-SUB

pendant subwoofer

On-Axis Frequency Response ⁶

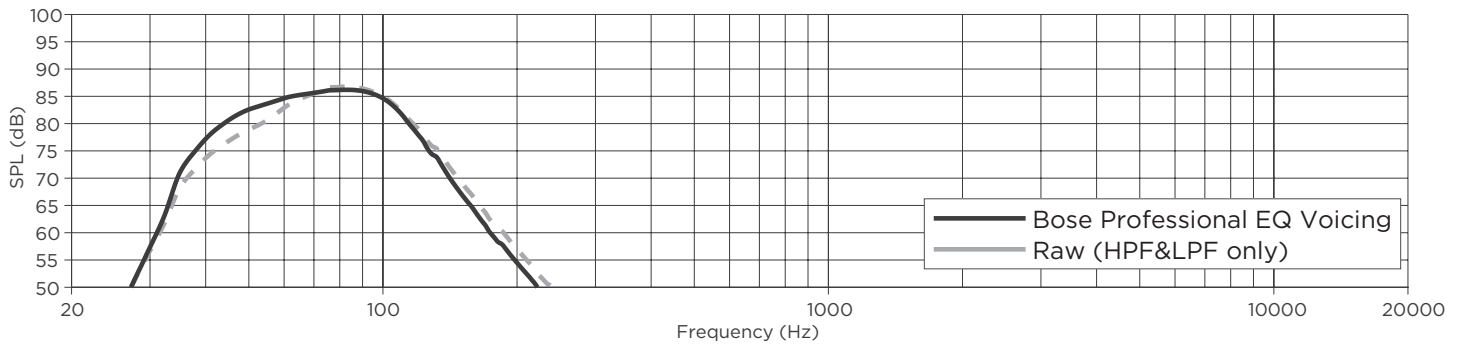

Impedance

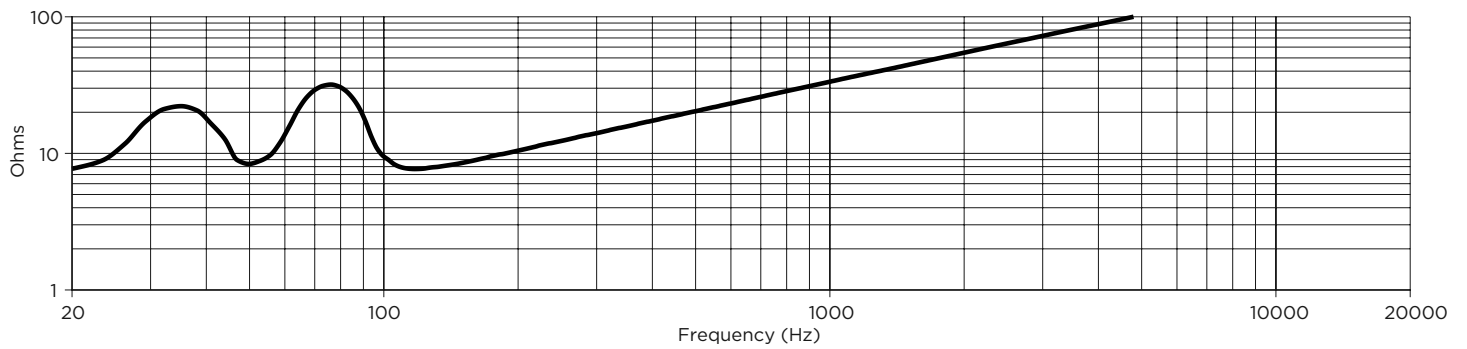

TECHNICAL DATA

DesignMax DM10P-SUB

pendant subwoofer

Dimensions

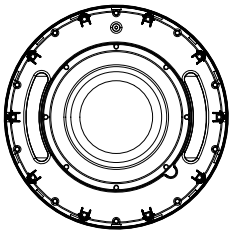
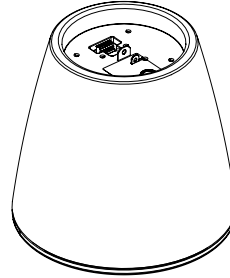
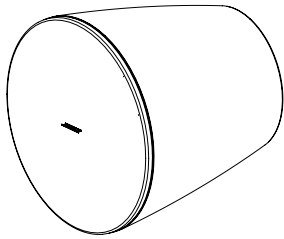

Front View
GRILLE REMOVED FOR CLARITY

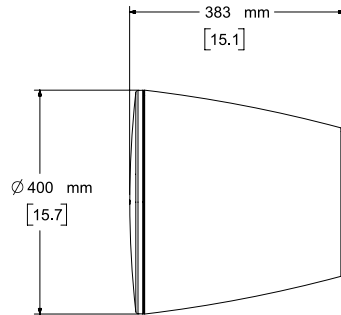

Right View
DIMENSIONS APPLY TO BOTH SIDES

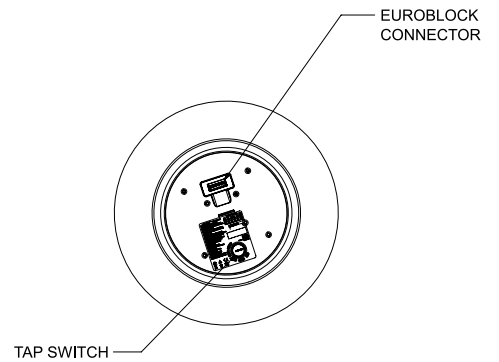

Rear View

- NOTES:
1. DIMENSIONS ARE IN MILLIMETERS OVER INCHES
 2. WEIGHT APPROX 8.9kg [19.7lbs]

Bose is a trademark of Bose Corporation.
DesignMax, QuickHold, and SmartBass are trademarks of Transom Post OpCo LLC.
Gripple is a registered trademark of Gripple Limited.
All other trademarks are the property of their respective owners.

For additional specifications and application information, please visit BOSEPROFESSIONAL.COM
Specifications subject to change without notice. 05/2023