



SOUND SOLUTIONS



ACCENTO DYNAMICA KEVLAR CEILING SPEAKER PAIR WITH MAGNETIC GRILLE

MICRO-FLANGE

Modern low profile flange design that's unobtrusive and slim line that will suit traditional and modern decor's seamlessly.

SUSPENDED TWEETER SYSTEM

Suspended 20mm Titanium dome tweeter with silk surround, above mounted in coaxial configuration for excellent HiFi audio sound. Selectable tweeter attenuation adjustment. Ball-in-socket tweeter tilt adjustment.

HI-END WOOFER CONSTRUCTION

Cone construction is made from black woven kevlar material designed and constructed to be light but rigid for excellently controlled tight bass with live natural sound. Mounted in an anodised metal basket with butyl rubber surround for long exertion high SPL efficiency, low resonance and long life durability. Premium audio quality.

CROSS-OVER NETWORK

Engineered using high quality components designed to perfectly match the tweeter and woofer for exceptional sound reproduction. 12dB/Octave with tweeter level attenuation adjustment.

Tweeter Attenuator



Ultra Low Profile Micro-Flange Magnetic Grille

High Quality Cross-Over Network UL-8540T Protective back

Premium audio Kevlar woofer with suspended coaxial neodymium magnet titanium tweeter

BLACK GRILLE

Replacement ultra low profile grille available in black. Grille Only. Sold separately. See Page: 7



WIRELESS VERSION AVAILABLE

Bluetooth speaker set includes an active speaker with a built in amplifier and a passive speaker. The amplified speaker includes connections for power and optional RCA line input. Connects to the 2nd speaker with common speaker wire.



SERIES MODELS

8 OHM HIFI MODELS

Gold plated spring terminals for larger wire or 4mm plug connection to a standard 8 ohm HiFi audio amplifier. New super-slim grille for an ultra low profile flange with contemporary design. Multiple magnets hold the metal grille securely. Built from strong rigid plastics that are fire retardant to UL-8540T. Quick-install clamp system for 5 to 25mm thickness. Long-life driver design with sealed motor system, butyl rubber surround and an advanced woven kevlar yellow cone. Premium audio sound optimised with a 12dB crossover and a front fascia switch selectable tweeter attenuator. The 20mm Titanium dome tweeter with silk surround and phase cap provides a very natural high-end audio experience.

6 1/2" ADS65-100MG



Optional Replacement Black Grille. Part No: ICGR-6B

Code	ADS65-100MG
Size	6.5"
Input	8Ω
Freq.	55Hz-20kHz
Impedance	8Ω
Pmax	100W
Prms	50W
Sens.	88dB
Packaging	Pair

8" ADS8-160MG



Optional Replacement Black Grille. Part No: ICGR-8B

Code	ADS8-160MG
Size	8"
Input	8Ω
Freq.	50Hz-20kHz
Impedance	8Ω
Pmax	160W
Prms	80W
Sens.	89dB
Packaging	Pair

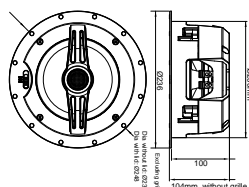

PASSIVE

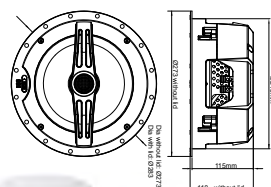

PASSIVE

AMPLIFIED MODELS WITH BLUETOOTH

A completely self contained audio solution with built-in stereo amplifier (external 240Vac power supply included). Standard audio RCA type inputs or using the convenience and utility of wireless streaming to an installation for direct, familiar device control via Bluetooth (over-rides the RCA input). Premium quality audio sound solution with kevlar woofers and titanium dome tweeters matched to a powerful and dynamic class-D amplifier. Dual speaker (stereo) package supplied as one passive and one active speaker with amp built-in plus power pack. RCA line level input or Bluetooth. Modern styling, sound quality, and connectability.

6 1/2" ADS65-60BT



Optional Replacement Black Grille. Part No: ICGR-6B

Code	ADS65-60BT
Size	6.5"
Speaker	Active
Bluetooth	V4.1+EDR
Freq.	55Hz-20kHz
Pmax	60W x2
Prms	30Wrms per channel
Sens.	88dB
Packaging	Pair

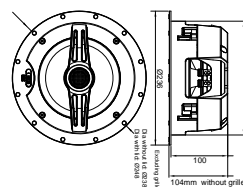

ACTIVE

8" ADS8-100BT



Optional Replacement Black Grille. Part No: ICGR-8B

Code	ADS8-100BT
Size	8"
Speaker	Active
Bluetooth	V4.1+EDR
Freq.	50Hz-20kHz
Pmax	100W x2
Prms	50Wrms per channel
Sens.	89dB
Packaging	Pair

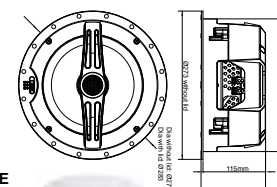

PASSIVE

ACCENTO DYNAMICA AMT CEILING SPEAKER PAIR WITH MAGNETIC GRILLE

MICRO-FLANGE

Modern low profile flange design that's unobtrusive and slim line that will suit traditional and modern decor's seamlessly.

AMT TWEETER SYSTEM

Air Motion Transformers (AMT) are high frequency electrostatic transducers that produce clarity with high transient speed. Unique to Accento-Dynamica, AMT tweeters achieve a level of musicality not normally found in a ceiling speaker system.

HI-END WOOFER CONSTRUCTION

Cone construction is made from black woven kevlar material designed and constructed to be light but rigid for excellently controlled tight bass with live natural sound. Mounted in an anodised metal basket with butyl rubber surround for long exertion high SPL efficiency, low resonance and long life durability. Premium audio quality.

CROSS-OVER NETWORK

Engineered using high quality components designed to perfectly match the tweeter and woofer for exceptional sound reproduction. 12dB/Octave with ATM Tweeter level attenuation adjustment.



SERIES MODELS

New super-slim grille for an ultra low profile flange of contemporary design. Multiple magnets hold the metal grille securely. Built from strong rigid plastics that are fire retardant to UL-8540T. Quick-install clamp system for 40 to 10mm thickness. High exertion butyl rubber surround and an advanced woven kevlar black cone for quality, strength and durability. Premium audio sound optimised with a 12dB crossover and a front facia switch selectable tweeter attenuator. Air Motion Transformers (AMT) are high frequency electrostatic transducers that produce clarity with high transient speed. Gold plated spring terminals for larger bare wire or 4mm plug connection to any 8 ohm HiFi audio amplifier.



AMT Super-Tweeter

6½" ADS65AMT-120MG



Optional Replacement Black Grille, Part No: MIGR-6B

Code	ADS65AMT-120MG
Size	6.5"
Input	8Ω
Freq.	56Hz-20kHz
Impedance	8Ω
Pmax	120W
Prms	60W
Sens.	89dB
Packaging	Pair

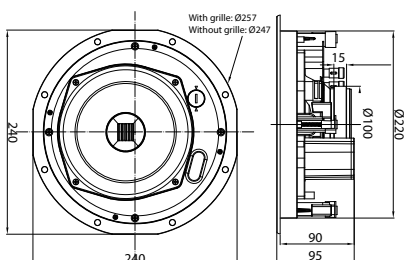

8" ADS8AMT-160MG



Optional Replacement Black Grille, Part No: MIGR-8B

Code	ADS8AMT-160MG
Size	8"
Input	8Ω
Freq.	48Hz-20kHz
Impedance	8Ω
Pmax	160W
Prms	80W
Sens.	90dB
Packaging	Pair

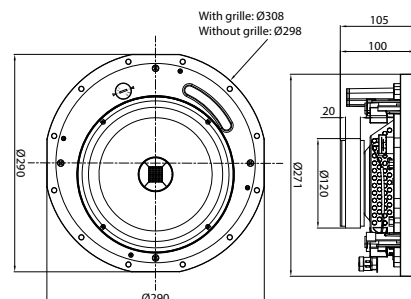

ACCENTO DYNAMICA 8Ω MICA-PP CEILING SPEAKER PAIR WITH MAGNETIC GRILLE

MICRO-FLANGE

Modern low profile 5mm flange design that's unobtrusive and slim line that will suit traditional and modern decor's seamlessly.

SUSPENDED TWEETER SYSTEM

Suspended 20mm Titanium dome tweeter with silk surround, above mounted in coaxial configuration for excellent HiFi audio sound. Ball-in-socket tweeter angle adjustment. Tweeter level control for HF brightness.

HI-END WOOFER CONSTRUCTION

Cone construction is made from blue Mica-Polypropylene material designed and constructed to be light but rigid for excellently controlled tight bass with live natural sound. Butyl rubber surround for long exertion high SPL efficiency, low resonance and long life durability.

CROSS-OVER NETWORK

Engineered using high quality components 12dB/Octave designed to perfectly match the tweeter and woofer for exceptional sound reproduction. Tweeter attenuator adjustment.

BLACK GRILLE

Replacement ultra low profile grille available in black. Grille Only. Sold separately. See Page: 7



SOLD IN PAIRS

SERIES MODELS

Super-slim grille design for an ultra low profile flange of only 5mm. Multiple neodymium magnets hold the metal grille securely. Built from strong rigid plastics that are fire retardant to UL-8540T. Quick-install clamp system for 40 to 10mm panel thickness. Long-life driver design with sealed motor system, butyl rubber surround and mica reinforced polypropylene composite cone. 20mm Titanium dome tweeter with silk surround above mounted in coaxial configuration for excellent HiFi audio sound. Premium audio sound optimised with a 6dB crossover and a front fascia switch selectable tweeter volume level attenuator. Spring terminals for easy bare wire connection to any standard 8 ohm HiFi audio amplifier.



Titanium Dome

4" ADS4-60MG



Optional Replacement Black Grille. Part No: MIGR-4B

Code	ADS4-60MG
Size	4"
Input	8Ω
Freq.	95Hz-20kHz
Impedance	8Ω
Pmax	60W
Prms	30W
Sens.	85dB
Packaging	Pair

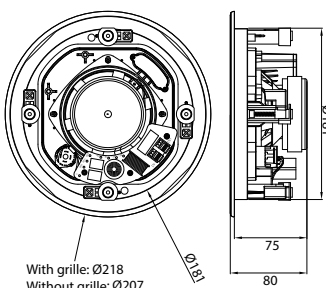

6½" ADS65-80MG



Optional Replacement Black Grille. Part No: MIGR-6B

Code	ADS65-80MG
Size	6.5"
Input	8Ω
Freq.	60Hz-20kHz
Impedance	8Ω
Pmax	80W
Prms	40W
Sens.	87dB
Packaging	Pair

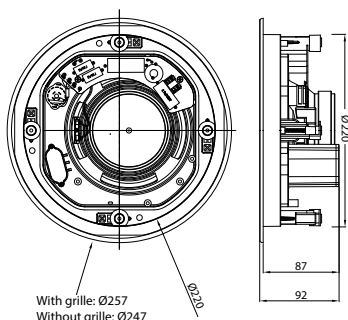

8" ADS8-120MG



Optional Replacement Black Grille. Part No: MIGR-8B

Code	ADS8-120MG
Size	8"
Input	8Ω
Freq.	50Hz-20kHz
Impedance	8Ω
Pmax	120W
Prms	60W
Sens.	88dB
Packaging	Pair

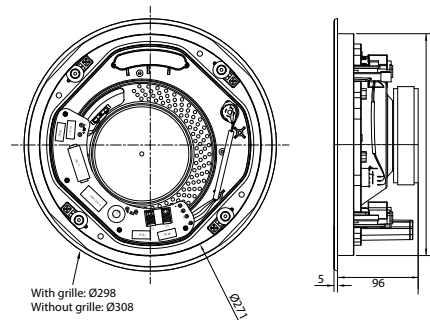

ACCENTO DYNAMICA 8Ω OR 100V TYPE CEILING SPEAKER WITH MAGNETIC GRILLE

8 OHM HI-FI / 100V INPUT

Flexible Installation options can be connected to 8 Ohm Hi-Fi or 100V PA installations. High end cross-over design. Multiple 100V Watt Tap Selections.

2-WAY COAXIAL SYSTEM

Suspended 20mm Titanium dome tweeter with silk surround above mounted in coaxial configuration for excellent HiFi audio sound. Tweeter level adjustment.

SUPER SLIM GRILLE

Magnetically held speaker creates a ultra low profile 5mm and virtually frameless appearance as well making installation faster.

BLACK GRILLE

Replacement ultra low profile grille available in black. Grille Only. Sold separately. See Page: 7

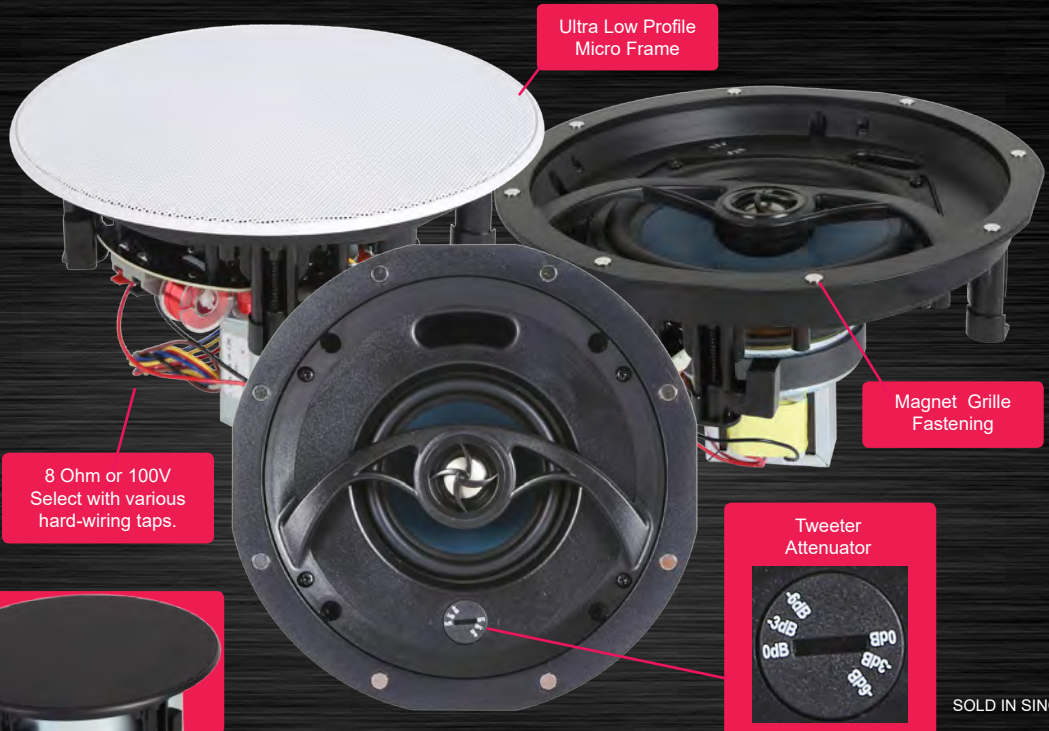

SOLD IN SINGLES

SERIES MODELS

Super-slim grille with ultra low profile flange of only 5mm. Multiple magnets hold the metal grille securely. Easy to install. Built from strong rigid plastics that are fire retardant to UL-8540T. Quick-install clamp system for 40 to 10mm panel thickness. Long-life driver design with sealed motor system for dust tolerance. Featuring a 100V line audio transformer with taps for PA installations which can be bypassed for direct 8 ohm input if required. Premium audio sound optimised with a 6dB crossover and a front facia selectable tweeter attenuator. 20mm Titanium dome tweeter with silk surround above mounted in coaxial configuration for excellent HiFi audio sound. Butyl rubber surround and mica reinforced polypropylene composite cone. Achieves excellent quality full-range audio sound reproduction.



4" ADS4-60MG-T20



Optional Replacement Black Grille. Part No: MIGR-4B

Code	ADS4-60MG-T20
Size	4"
Input	100V
Taps	2.5W / 5W / 10W / 20W
Freq.	96Hz-20kHz
Pmax	40W
Prms	20W
Sens.	85dB
Packaging	Single

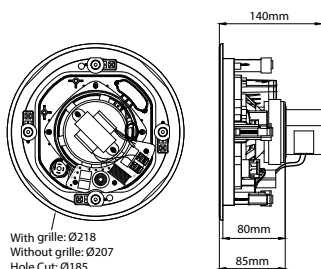

With grille: Ø218
Without grille: Ø207
Hole Cut: Ø185

6.5" ADS65-80MG-T40



Optional Replacement Black Grille. Part No: MIGR-6B

Code	ADS65-80MG-T40
Size	6.5"
Input	100V
Taps	5W / 10W / 20W / 40W
Freq.	61Hz-20kHz
Pmax	80W
Prms	40W
Sens.	87dB
Packaging	Single

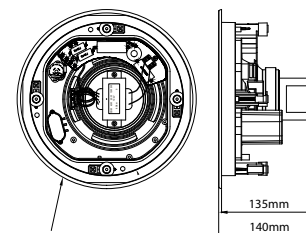

With grille: Ø257mm
Without grille: Ø247mm
Hole Cut: Ø220mm

ACCENTO DYNAMICA 8Ω / 100V TYPE CEILING SPEAKER SEALED BACK

100V INPUT

Designed for commercial 100V PA installations.

FULLY ENCASED

Improved sound, long-life and safety with the a sealed metal back cover. Fire retardant materials used.

2-WAY COAXIAL SYSTEM

Suspended 20mm Titanium dome tweeter with silk surround. Above mounted in a coaxial configuration for excellent Hi-Fi audio sound.

SUPER SLIM GRILLE

Magnetically held metal grille creates an ultra low profile and virtually frameless appearance as well as making installation faster and easier.

Ultra Low Profile Micro Frame

Easy Tap Selection



Magnet Grille Fastening

BLACK GRILLE

Replacement ultra low profile grille available in black. Grille Only. Sold separately. See Page: 7

SOLD IN SINGLES

SERIES MODELS

New super-slim grille with ultra low profile flange of only 5mm. Multiple magnets hold the metal grille securely. Easy to install. This model has an extruded metal back-cover that is fire retardant and gives added ingress protection. Ideal for ceilings where acoustic isolation is required and also improves the speakers sound. Quick-install clamp system for 40mm to 10mm ceiling panel thickness. Long-life driver design with sealed motor system, butyl rubber surround and a mica reinforced polypropylene composite cone. Extended performance with a Titanium dome tweeter with silk surround, above mounted in coaxial configuration. Includes a 12dB matching crossover. There is an easy-access rotary-switch on the front panel for selecting the 100V Taps or 8 Ohm type input. Sold as singles.

4" ADS4-60MG-CT10



Optional Replacement Black Grille. Part No: MIGR-4B

Code	ADS4-60MG-CT10
Size	4"
Input	8Ω / 100V
Switch	8Ω / 1.25W / 2.5W / 5W / 10W
Freq.	96Hz-20kHz
Pmax	60W
Prms	30W
Sens.	85dB
Packaging	Single

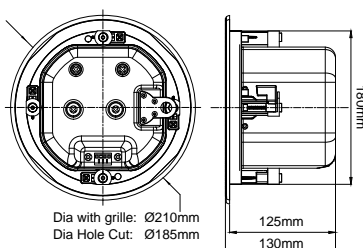

6.5" ADS65-80MG-CT40



Optional Replacement Black Grille. Part No: MIGR-6B

Code	ADS65-80MG-CT40
Size	6.5"
Input	8Ω / 100V
Switch	8Ω / 5W / 10W / 20W / 40W
Freq.	61Hz-20kHz
Pmax	80W
Prms	40W
Sens.	87dB
Packaging	Single

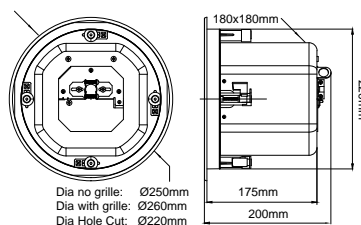

8" ADS8-100MG-CT60



Optional Replacement Black Grille. Part No: MIGR-8B

Code	ADS8-100MG-CT60
Size	8"
Input	8Ω / 100V
Switch	8Ω / 7.5W / 15W / 30W / 60W
Freq.	55Hz-20kHz
Pmax	120W
Prms	60W
Sens.	88dB
Packaging	Single

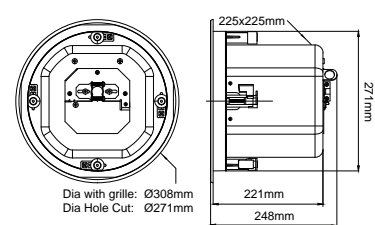

IN-CEILING SPEAKER MOUNTING BRACKET

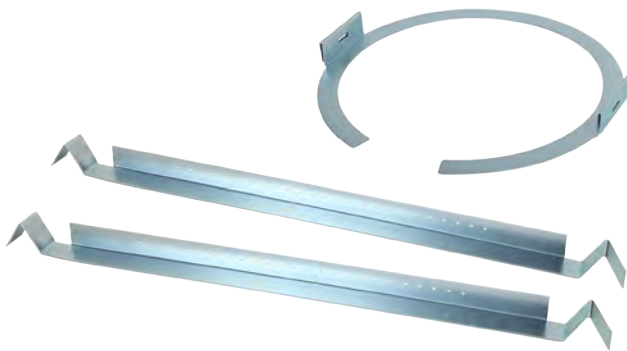
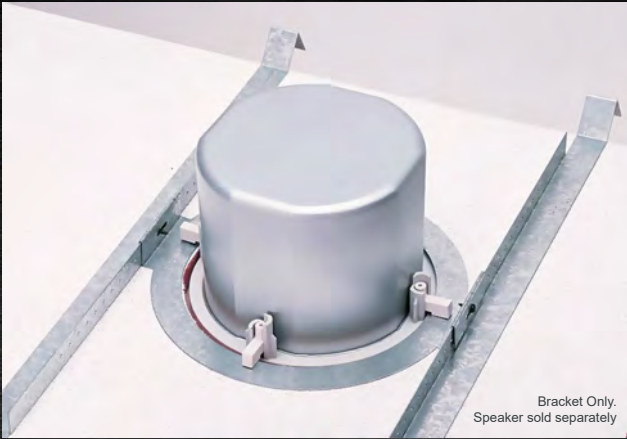

This bracket is designed for an easy and secure way of installing in-ceiling speakers and are suitable for drywall or drop ceiling. The kits include two bridge brackets which spans the width of the ceiling tile and puts the weight of the speaker on the ceiling frame instead of the tile itself. It also includes a speaker ring that can be secured to the brackets. Ring size is internal diameter (Hole).

Code	CLBKT-4	CLBKT-6	CLBKT-8
Suits	ADS4	ADS65	ADS8
Ring Size	180mmØ	220mmØ	270mmØ

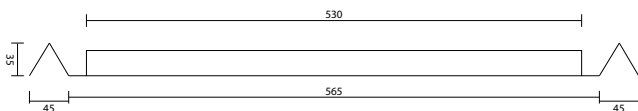

BLACK SPEAKER GRILLES MAGNETIC MOUNT



Grille Only. Speaker sold separately

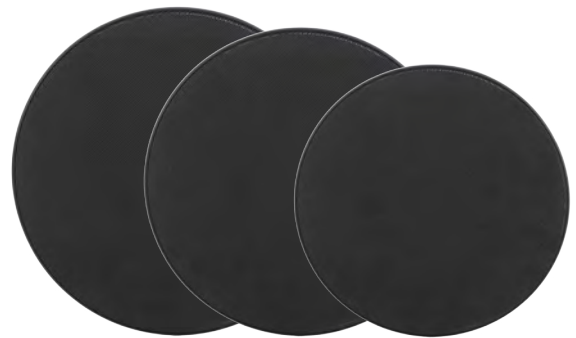

These metal speaker grilles are tailored to suit Accento Dynamica range of speakers that use a magnetic speaker grille cover. Easy to install. The magnet system on your speakers will hold the grille tightly. Sold in single units. 2 required for pairs.

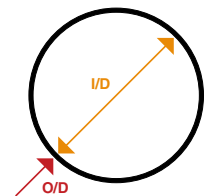

Code	MIGR-4B	MIGR-6B	MIGR-8B
Colour	Black	Black	Black
I/D	207mm	247mm	298mm
O/D	218mm	257mm	308mm
Suits	ADS4-60MG, ADS4-60MG-CT10, ADS4-60MG-T20	ADS65-80MG, ADS65AMT-120MG, ADS65-80MG-T40, ADS65-80MG-CT40	ADS8-120MG, ADS8AMT-160MG

Code	ICGR-6B	ICGR-8B
Colour	Black	Black
I/D	238mm	273mm
O/D	248mm	283mm
Suits	ADS65-60BT, ADS65-100MG	ADS8-100BT, ADS8-160MG

ACCENTO DYNAMICA PREMIUM HIFI 2-WAY 8 OHM PAIR

MICRO-FLANGE

Modern low profile (7mm) flange design that's unobtrusive and slim line that will suit traditional and modern decor's seamlessly.

SUSPENDED TWEETER SYSTEM

High quality 1" Silk dome ferro fluid cooled neodymium magnet tweeter for beautiful sound and high end. Mounted independently and suspended from the woofer to ensure the tweeter and woofer work in perfect harmony.

HI-END WOOFER CONSTRUCTION

Cone construction is made from black woven fibre-glass material designed and constructed to be light but rigid for excellently controlled tight bass with live natural sound. Mounted in an anodised metal basket with butyl rubber surround for long exertion, high SPL efficiency, low resonance and long life durability.

CROSS-OVER NETWORK

Engineered using high quality components designed to perfectly match the tweeter and woofer for exceptional sound reproduction. 12dB/Octave with adjustable 0dB / 3dB / 6dB Tweeter level adjustment.



**ALUMINIUM
GRILLES**

SOLD IN PAIRS

SERIES MODELS



**BE HEARD
SEND YOUR MESSAGE
LOUD & CLEAR**



6 1/2" ADS65M50

25mm aluminium voice coil. Black fibre-glass cone. Inverted dust cap. Butyl rubber surround. Anodised metal basket. 25mm Mylar dome tweeter Ferro fluid cooled Neodymium magnet. 12dB/Octave cross-over 8 Ohm. Push terminals. High 89dB/1W Sensitivity. Swivel clamp mounting. Fits a 202mm hole. Power 50Wrms (100Wmax). Aluminium grilles for long life & no discolouration.

Code	ADS65M50
Size	6.5"
Freq.	61Hz-20KHz
Input	8Ω
Pmax	100W
Prms	50W
Sens.	89dB
Packaging	Pair

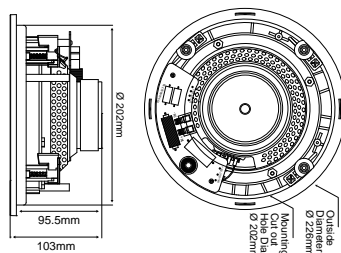

8" ADS8M80

35mm aluminium voice coil. Black fibre-glass cone. Inverted dust cap. Butyl rubber surround. Anodised metal basket. 25mm Mylar dome tweeter Ferro fluid cooled Neodymium magnet. 12dB/Octave cross-over 8 Ohm. Push terminals. High 90dB/1W Sensitivity. Swivel clamp mounting. Fits a 245mm hole. Power 80Wrms (160Wmax). Aluminium grilles for long life & no discolouration.

Code	ADS8M80
Size	8"
Freq.	40Hz-20KHz
Input	8Ω
Pmax	160W
Prms	80W
Sens.	90dB
Packaging	Pair

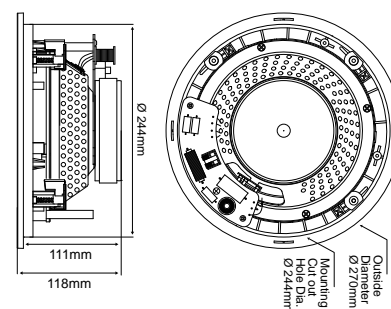

ACCENTO DYNAMICA KEVLAR HIFI 2-WAY 8 OHM PAIR

RAPID INSTALLATION SYSTEM !

Unique Push-To-Release spring loaded auto mounting clamps. Spiral fastener auto-fits ceiling depth 10-25mm. Use the 1/4" Allen Key (Included) for easy half-turn release of the clamp to remove the speaker. Time saving, simple, reliable and no-fuss mounting process.

LOW-PROFILE FLANGE

Modern 7mm profile flange design that's unobtrusive and slim line that will suit traditional and modern decor's seamlessly.

TILT COAXIAL TWEETER

High quality 1" Silk dome ferro fluid cooled neodymium magnet tweeter for a beautiful high frequency response. Tweeter can be tilted to give directionality to sound and an attenuator switch for softening presence and flawless sound.

HI-END WOOFER CONSTRUCTION

Cone construction is made from woven Kevlar material designed for premium sound quality audio & warm bass. Mounted in an anodised metal basket with butyl rubber surround for long exertion high SPL efficiency, low resonance and long life durability.

CROSS-OVER NETWORK

Engineered using high quality components designed to perfectly match the tweeter and woofer for exceptional sound reproduction. 12dB/Octave with adjustable 0dB / 3dB / 6dB Tweeter level adjustment under the front grille.



RAPID INSTALL SYSTEM
8 SECOND INSTALLATION.
SEE PAGE 14 FOR DETAILS

SOLD IN PAIRS

SERIES MODELS



6½" ADS65F40

Rapid Push-Release mounting system for quick & easy install in seconds ! Premium high-end audio sound quality with durable and reliable components. Yellow woven Kevlar mid-woofer 6½" Long-life Butyl Rubber roll surround, 25mm Aluminium high temp' voice coil. Anodised steel frame, back grille. 25mm Dome tweeter with tilt adjust and a high range attenuator switch. 12dB/Octave electronic crossover. Arctic white removable metal grille. Attractive, reliable, beautiful sound. 40Wrms (80Wmax), 87dB, 60Hz-20KHz 8 Ohm. Aluminium grilles for long life.

Code	ADS65F40
Size	6.5"
Input	8Ω
Freq.	55Hz-20KHz
Pmax	80W
Prms	40W
Sens.	87dB
Packaging	Pair

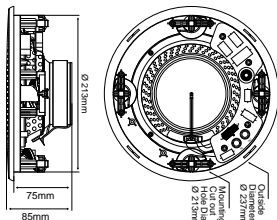

8" ADS8F80

Rapid Push-Release mounting system. Quick & easy Install in seconds ! Premium high-end audio sound quality with durable and reliable components. Yellow woven Kevlar mid-woofer 8". Long-life Butyl Rubber roll surround. 35mm Aluminium high temp' voice coil. Anodised steel frame back grille. 25mm Dome tweeter with tilt adjust and a high range attenuator switch. 12dB/Octave electronic crossover. Arctic white removable metal grille. Attractive, reliable, beautiful sound. 80Wrms (160Wmax), 90dB, 50Hz-20KHz. 8 Ohm. Aluminium grilles for long life.

Code	ADS8F80
Size	8"
Input	8Ω
Freq.	53Hz-20KHz
Pmax	160W
Prms	80W
Sens.	90dB
Packaging	Pair

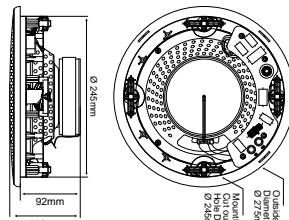

6½" ADS365F40

Rapid Push-Release mounting system Quick & easy Install in seconds ! Premium high-end audio sound quality with durable and reliable components. Yellow woven Kevlar mid-woofer 6½" Long-life Butyl Rubber roll surround. 25mm Aluminium high temp' voice coil. Anodised steel frame back grille. 25mm Dome tweeter with tilt adjust and a high range attenuator switch. 12dB/Octave electronic crossover Arctic white removable metal grille. Attractive, reliable, beautiful sound 40Wrms (80Wmax) 87dB 60Hz-20KHz 8 Ohm. Aluminium grilles for long life and no discolouration.

Code	ADS365F40
Size	6.5"
Input	8Ω
Freq.	55Hz-20KHz
Pmax	80W
Prms	40W
Sens.	87dB
Packaging	Pair

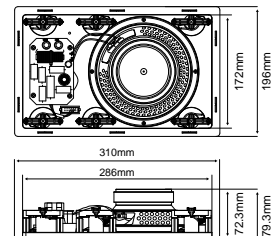

ACCENTO DYNAMICA HI-FI CEILING SPEAKER SYSTEMS 2-WAY 8 OHM PAIR

SAFETY PLASTIC

Constructed from Fire retardant plastics to UL-8540T.

TILT COAXIAL TWEETER

High quality titanium tweeter for beautiful sound and high end response. Tweeter can be tilted to give directionality to the sound and an attenuator switch for softening presence for flawless ceiling audio.

HI-END WOOFER CONSTRUCTION

Cone construction is made from woven Kevlar material designed for premium sound quality audio & warm bass. Mounted in an anodised metal basket with butyl rubber surround for long exertion, high SPL efficiency, low resonance and long life durability.

CROSS-OVER NETWORK

Match the tweeter and woofer for excellent sound reproduction. PTC overload protection devise. Push terminals for speaker wires.



SOLD IN PAIRS

SERIES MODELS



5 1/4" ADS2550

High performance premium grade. 2-Way coaxial w/ PTC overdrive protected tweeter titanium coated. Kevlar Mid-Woofer. 8 Ohm input. HiFi Spring terminals O/D Frame 215mmØ Hole Mount 175mmØ Cavity depth 75mm 50Wrms 100Wmax 70Hz-20KHz 88dB Aluminium grilles for long life and no discolouration.

Code	ADS2550
Size	5.25"
Freq.	70Hz-20KHz
Input	8Ω
Taps	Nil
Sens.	88dB
Pmax	100W
Prms	50W
Packaging	Pair

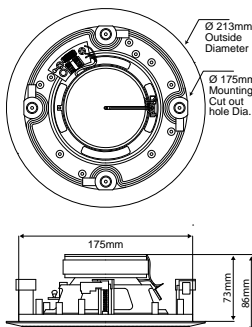

6 1/2" ADS2660

High performance premium grade. 2-Way coaxial w/ PTC overdrive protected tweeter titanium coated. Kevlar Mid-Woofer. 8 Ohm input. Spring terminals O/D Frame 240mmØ Hole Mount 205mmØ Cavity depth 75mm 60Wrms 120Wmax 60Hz-20KHz 89dB Aluminium grilles for long life and no discolouration.

Code	ADS2660
Size	6.5"
Freq.	60Hz-20KHz
Input	8Ω
Taps	Nil
Sens.	89dB
Pmax	120W
Prms	60W
Packaging	Pair

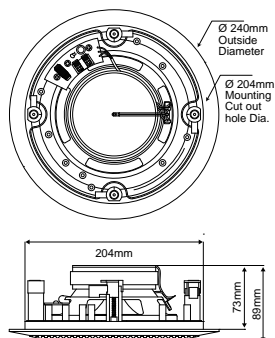

8" ADS2880

High performance premium grade. 2-Way coaxial w/ PTC overdrive protected tweeter titanium coated. Kevlar Mid-Woofer. 8 Ohm input. Spring terminals Frame 280mmØ Hole Mount 245mmØ Cavity depth 90mm 80Wrms 160Wmax 50Hz-20KHz 92dB Aluminium grilles for long life and no discolouration.

Code	ADS2880
Size	8"
Freq.	50Hz-20KHz
Input	8Ω
Taps	Nil
Sens.	92dB
Pmax	160W
Prms	80W
Packaging	Pair

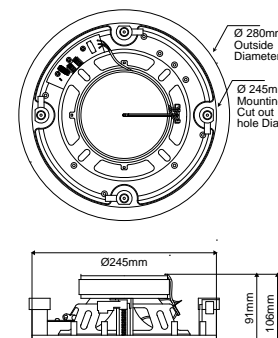

ACCENTO DYNAMICA 8Ω OR 100V TYPE CEILING SPEAKER SEALED-BACK

ENCLOSED CABINET / SEISMIC CABLE

Sealed cabinet design protects speaker. No dirt, no dust and no vermin. Also gives better bass and reduce cavity vibration. With attachment point for seismic cable (safety cord).

SAFETY PLASTIC

Constructed from Fire retardant plastics to UL-8540T.

TILT COAXIAL TWEETER

High quality Titanium tweeter for beautiful sound and high end response. Tweeter can be tilted to give directionality to sound and an attenuator switch for softening presence for excellent audio quality ceiling audio.

HI-END WOOFER CONSTRUCTION

Cone construction is made from woven Kevlar material designed for premium sound quality with warm, authoritative bass, high SPL efficiency, low resonance and long life durability to ensure enduring reliability.

CROSS-OVER NETWORK

Engineered using high quality components designed to perfectly match the tweeter and woofer for exceptional sound reproduction. Rear switched tweeter level attenuator.



SOLD IN SINGLES

SERIES MODELS



5 1/4" ADS1550

KEVLAR & TITANIUM

High performance Audiophile grade. 2-Way coaxial with PTC Overdrive protected titanium coated tweeter. 5 1/4" Kevlar Mid-Woofer. High Power, Long life and Hi-Fidelity. Input Options: 8 Ohm & 100V 6W / 3W / 1.5W Taps.

Code	ADS1550
Size	5.25"
Input	8Ω / 100V Taps 6W / 3W / 1.5W
Pmax	100W
Prms	50W
Freq.	70Hz-20Khz
Sens.	88dB
Packaging	Single

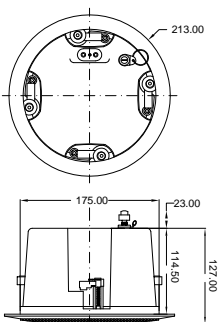

6 1/2" ADS1660

KEVLAR & TITANIUM

High Performance. PTC Protected titanium tweeter with adjustable tilt. Kevlar 6 1/2" Woofer Aluminium voice coil. High Power, Long life and fidelity. Input Options: 8 Ohm & 100V: 30W / 15W / 7.5W Taps.

Code	ADS1660
Size	6.5"
Input	8Ω / 100V Taps 30W / 15W / 7.5W
Pmax	120W
Prms	60W
Freq.	66Hz-20Khz
Sens.	88dB
Packaging	Single

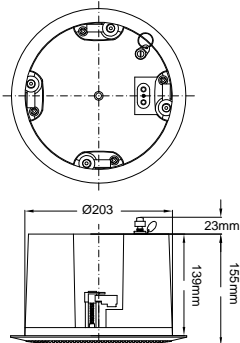

8" LOW PROFILE ADS1850

KEVLAR & TITANIUM

Suitable Small Ceiling cavity. 2-Way coaxial with Titanium Tweeter & Polypropylene 8" woofer for superior bass. Aluminium voice coil. High Power, Long life and Hi-Fidelity. Input Options: 8 Ohm & 100V: 30W / 15W / 7.5W Taps.

Code	ADS1850
Size	8"
Input	8Ω / 100V Taps 30W / 15W / 7.5W
Pmax	100W
Prms	50W
Freq.	45Hz-20KHz
Sens.	88dB
Packaging	Single

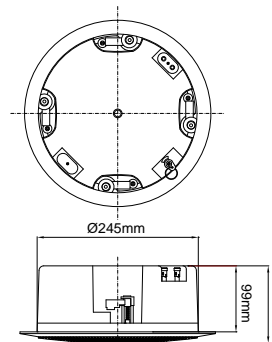

8" ADS1880

POLYPROPYLENE

High Performance. PTC Protected titanium tweeter with adjustable tilt. Kevlar 8" Woofer with aluminium voice coil for extra High Power and Long life. Input Options: 8 Ohm & 100V: 50W / 25W / 12.5W Taps.

Code	ADS1880
Size	8"
Input	8Ω / 100V Taps 50W / 25W / 12.5W
Pmax	160W
Prms	80W
Freq.	50Hz-20KHz
Sens.	90dB
Packaging	Single

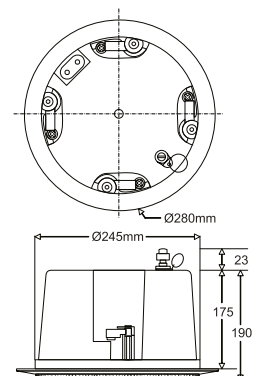

ACCENTO DYNAMICA 5¼" 2-WAY 8 OHM PAIR RECTANGLE CEILING / IN-WALL

Exceptional sound reproduction delivered from the 2-Way or 3-Way speaker systems for a full spectrum audio experience. Perfectly matched crossover using high quality components to maintain signal clarity and definition with adjustable tweeter brightness control on front (3-Way model only). Ideal for home theatre applications for use as front stage Left / Centre / Right using an In-Wall configuration. Also suits high end multi-room audio applications.



SOLD IN PAIRS

SERIES MODELS



RE-LIVE IT
HIGH FIDELITY SOUND
REPRODUCTION

5¼" 2-WAY 8 OHM ADS528

Modern Micro Flange Style. High End Sound reproduction via twin Mid-Woofer configuration. 25mm Dynamic Silk Dome Neodymium Tweeter. The two High Performance 5¼" Mid-Woofer's, perfectly matched crossover to a dynamic tweeter makes these wall speakers an ideal solution for home theatre applications for use as front stage Left / Centre / Right using an In-Wall or In-Ceiling configuration. Suitable for high end multi-room audio applications. Classic Flange Style. White with white aluminium grille. Facia is 175x345mm, hole cut out 155x325mm.

Code	ADS528
Size	5.25"
Input	8Ω
Pmax	80W
Prms	40W
Freq.	62Hz-20KHz
Sens.	86dB
Packaging	Pair

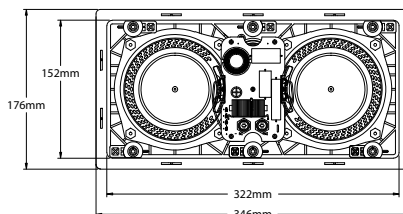
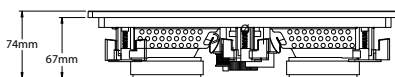

6½" 3-WAY 8 OHM ADS658

Exceptional sound reproduction delivered from a 3-Way speaker system for a full spectrum, quality audio experience. 25mm Dynamic Silk Dome Neodymium Tweeter. 1x 5¼" Mid-Range Polypropylene. 1x 6½" Kevlar Woofer. Perfectly matched crossover using high quality components to maintain signal clarity and definition with adjustable tweeter brightness control on the front panel. Ideal for home theatre applications for use as front stage L/C/R. Quick In-Wall installation. Excellent solution high-end multi-room audio applications. Aluminium grilles for long life and no discolouration. Facia is 360x210mm.

Code	ADS658
Size	6.5"
Input	8Ω
Pmax	160W
Prms	80W
Freq.	50Hz-20KHz
Sens.	89dB
Packaging	Pair

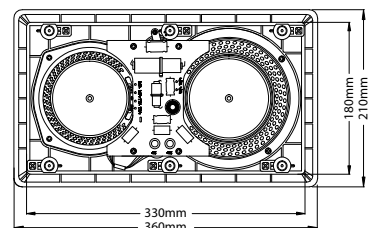
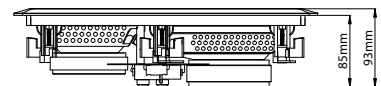

ACCENTO DYNAMICA SQUARE FRAME

6½" & 8" HiFi 2-WAY 8Ω

Modern Square frame Ceiling / In-Wall speaker will suit interiors where conventional round is not of choice. 8 Ohm Hi-Fi series featuring two way coaxial design with a high performance Kevlar woofer, 18mm Silk Dome Tweeter matched together using a high quality cross-over with adjustable tweeter brightness. Sold in pairs.



SOLD IN PAIRS

SERIES MODELS



6½" 2-WAY HiFi ADS680

HiFi 8 OHM Input. 2-Way Coaxial System. Kevlar Mid-Woofer with high resolution dynamic tweeter for excellent sound reproduction.

Code	ADS680
Size	6.5"
Input	8Ω
Pmax	100W
Prms	50W
Freq.	60Hz-20KHz
Sens.	88dB
Mount	Swivel Clamp 10mm
Packaging	Pair

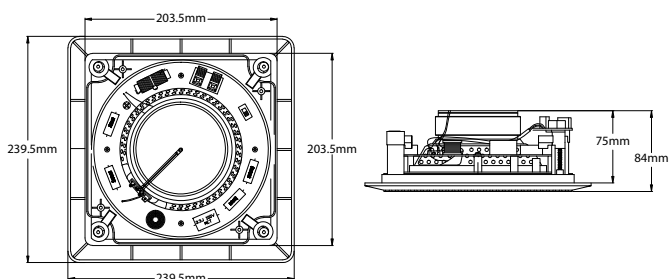

8" 2-WAY HiFi ADS860

HiFi 8 OHM Input. 2-Way Coaxial System. Kevlar Mid-Woofer with high resolution dynamic tweeter for excellent sound reproduction.

Code	ADS860
Size	8"
Input	8Ω
Pmax	120W
Prms	60W
Freq.	55Hz-20KHz
Sens.	89dB
Mount	Metal Bracket / Frame
Packaging	Pair

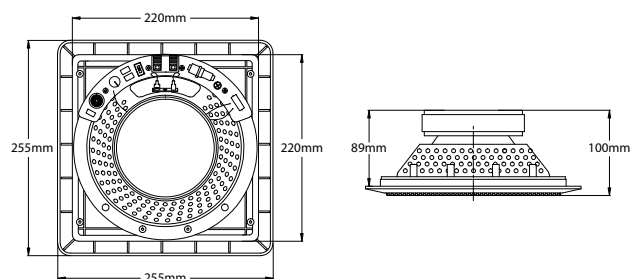

ACCENTO DYNAMICA QUICK INSTALL 8Ω / 100V

RAPID INSTALLATION SYSTEM !

Unique Push-To-Release spring loaded auto mounting clamps. Spiral fastener auto-fits ceiling depth 10-25mm. Use the 1/4" Allen Key (Included) for easy half-turn release of the clamp to remove the speaker. Time saving, simple, reliable and no-fuss mounting process.

2-WAY COAXIAL SYSTEM

High quality 13mm PEI dynamic tweeter for enhanced high frequency response.

APPLICATIONS

Suitable for most PA type applications for those who want a little bit Hi-Fi. These drivers include a 100V Line transformer with voltage taps via bare wires for in-line type connection enabling multiple speaker setups. For 8 Ohm input, the transformer should be disconnected and the 8 Ohm input wired to the speaker directly.

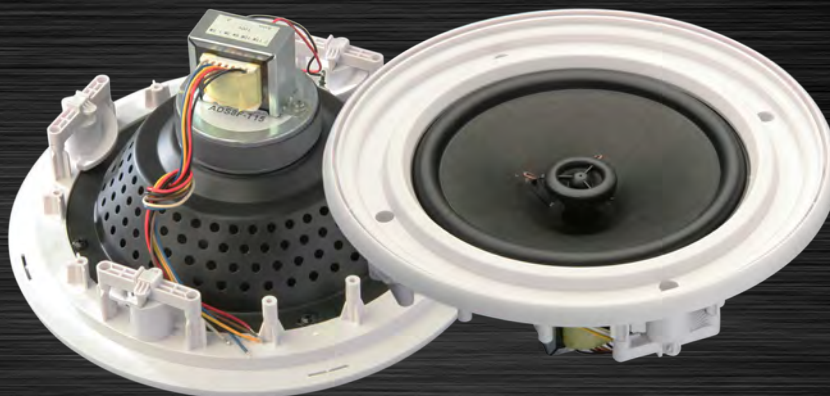

SOLD IN SINGLES

SERIES MODELS

RAPID INSTALL 8 SECOND INSTALLATION

1

Insert Speaker into Installation Location

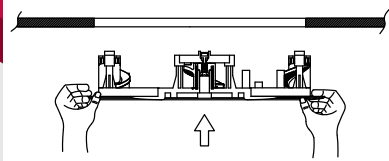

Required ceiling thickness must be between 10mm ~ 25mm

2

Use the thin side of the L shaped wrench to install the speaker. Simple push to release mounting tabs! Tabs will automatically release mount speaker to the ceiling.

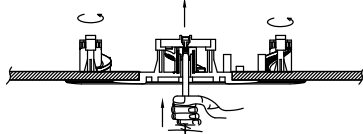

Released Tabs Lock Speaker into Ceiling

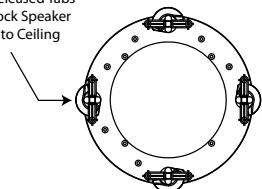

6 1/2" ADS65FT15

Rapid Push-Release mounting system. Quick & easy Install in seconds! Quality ABS plastic fascia surround. Arctic white metal removable grille. Metal frame & rear protection grille. 25mm Aluminium High Temp voice coil. Paper pulp HiFi mid-woofer speaker. Durable doped cloth roll surround. Centre pole mounted coaxial tweeter. 13mm dynamic Mylar cone tweeter. Includes 100V Line Transformer. Bare wire taps or 8 Ohm direct. 20Wrms(40Wmax) 87dB Sensitivity. 8Ω / 100V Taps: 15W-10W-6W-3W-1.5W Aluminium grilles for long life and no discolouration.

Code	ADS65FT15
Size	6.5"
Freq.	80Hz-20KHz
Input	8Ω / 100V Taps 15W / 10W / 6W / 3W / 1.5W
Pmax	30W
Prms	15W
Sens.	87dB
Packaging	Single

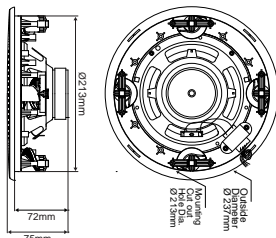

8" ADS8FT15

Rapid Push-Release mounting system Quick & easy Install in seconds! Quality ABS plastic fascia surround. Arctic white aluminium removable grille. Metal frame & rear protection grille. 25mm Aluminium High Temp voice coil. Paper pulp HiFi mid-woofer speaker. Durable doped cloth roll surround. Centre pole mounted coaxial 13mm dynamic Mylar cone tweeter. Includes 100V Line Transformer. Bare wire taps or 8 Ohm direct. 30Wrms(60Wmax) 87dB Sensitivity Taps: 15W-10W-6W-3W-1.5W Aluminium grilles for long life and no discolouration.

Code	ADS8FT15
Size	8"
Freq.	62Hz-20KHz
Input	8Ω / 100V Taps 15W / 10W / 6W / 3W / 1.5W
Pmax	30W
Prms	15W
Sens.	87dB
Packaging	Single

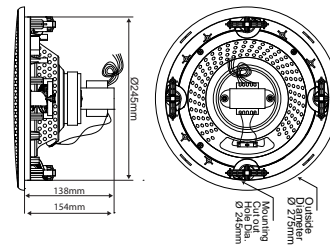

ACCENTO DYNAMICA

100V DUAL-CONE

METAL FRAME

Excellent cost effective solution.
Single piece stamped metal frame with a aluminium grille front fascia that will not discolour or rust over time.

DUAL-CONE SYSTEM

Paper pulp full range speaker cone.
Whizzer cone for high end response.

APPLICATION

Suitable for most PA type applications, these drivers include a 100V Line transformer with voltage taps via bare wires for in-line type connection enabling multiple speaker setups.

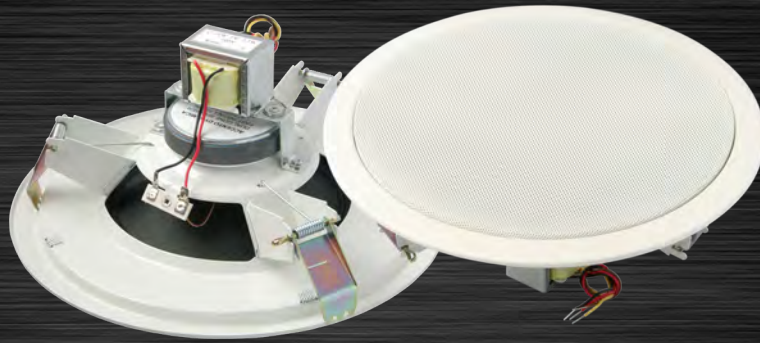

SOLD IN SINGLES

SERIES MODELS



5 1/4" ADS525FT6

Compact general purpose speaker. 110mm Paper pulp cone wide range. With whizzer cone for high end. Reliable metal construction. Neutral white powder coated. Finger spring mount system. Wide flange. (overhang) lip Hole 150mmØ (110-180mmØ). Built-in line transformer. 6Wrms(12Wmax) 87dB Sens. Taps 10W-5W-2.5W (8 Ohm). Aluminium grilles for long life.

Code	ADS525FT6
Size	5.25"
Input	8Ω / 100V Taps 6W / 3W / 1.5W
Freq.	186Hz-20KHz
Pmax	12W
Prms	6W
Sens.	87dB
Packaging	Single

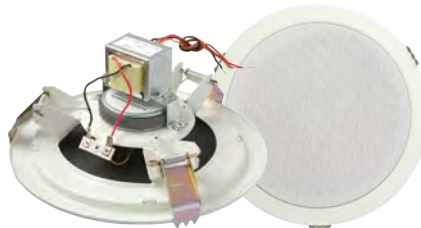
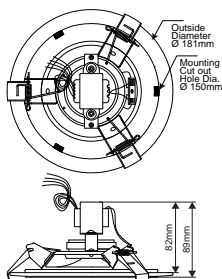

6 1/2" ADS65FT10

General purpose PA speaker 130mm Paper pulp cone wide range With whizzer cone for high end reliable metal construction. Neutral white powder coated. Finger spring mount system. Wide flange. (overhang) lip. Cutout: 165mmØ (130-200mmØ). Built-in line transformer 10Wrms(20Wmax). 87dB Sens. Taps 10W-5W-2.5W (8 Ohm). Aluminium grille for no discolouration.

Code	ADS65FT10
Size	6.5"
Input	8Ω / 100V Taps 10W / 5W / 2.5W
Pmax	20W
Prms	10W
Freq.	178Hz-20KHz
Sens.	87dB
Packaging	Single

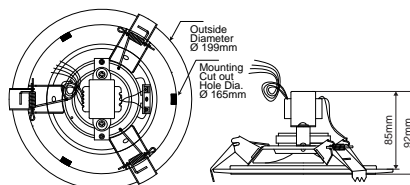

8" SQUARE ADS800

Modern Square frame Ceiling or In-Wall speaker will suit interiors where conventional round is not of choice. Dual cone speaker driver. Metal bracket mounting system for an extra tight secure hold. Cutout: 220x220mm. Grille: 255x255. Depth: 82mm. Built-in line transformer 20Wrms(40Wmax). 87dB Sens. Taps 6W-3W-1.5W (8 Ohm). Aluminium grille for no discolouration.

Code	ADS800
Size	8"
Input	100V Taps 6W / 3W / 1.5W
Pmax	40W
Prms	20W
Freq.	90Hz-20KHz
Sens.	90dB
Packaging	Single

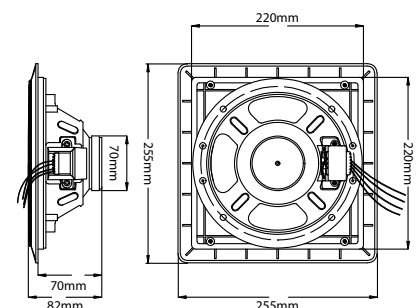

100V 4" CEILING SPEAKER METAL BOX



SOLD IN SINGLES

SERIES MODELS

METAL HOUSING. FAST INSTALL

Designed for 100V PA applications. Compact 4" ceiling speaker within an enclosed metal housing. Easy and Quick install just like a down-light in a $\varnothing 100\text{mm}$ mounting hole. Rear cover for fire retard and protects from ingress. Sold in singles.

100V PA SINGLE

Code	ADS400C
Size	4"
Input	100V Taps 6W / 3W / 1.5W
Taps	6W/3W/1.5W
Pmax	12W
Prms	6W
Freq.	130Hz-20KHz
Sens.	86dB
Packaging	Single

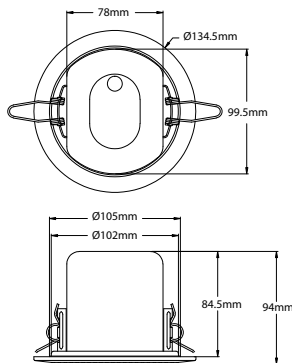

8 Ω / 100V-LINE COMPACT CUBE SPEAKER



ADS320
SOLD IN PAIRS

ADS950
SOLD IN SINGLES

HIGH PERFORMANCE SOUND FROM ONLY 90mm³

Super-compact, wedge shaped mini speaker for a discrete sound source with style and design that will fit into your decor seamlessly and provide excellent performance from such a small solution. Mount in a corner to increase presence even further. Ideal for surround home theatre or pair with a woofer for sound reinforcement. Includes adjustable ball joint mounting bracket to position for best audio experience and seismic cable for safety. Cube size is 87x87x112mm.

8 OHM HI-FI PAIR

Code	ADS320BK
Colour	Black
Input	8 Ω
Pmax	20W
Prms	10W
Freq.	130Hz-20KHz
Sens.	80dB
Packaging	Pair

100V PA SINGLE

Code	ADS950BK
Colour	Black
Input	100V Taps 6W / 3W / 1.5W
Taps	1.5W/3W/6W
Pmax	20W
Prms	10W
Freq.	130Hz-20KHz
Sens.	80dB
Packaging	Single

COHERENCE
DELIVERING YOUR MESSAGE
THE FIRST TIME & EVERY TIME



ACCENTO DYNAMICA 5" STEREO ACTIVE SPEAKERS



ACTIVE SPEAKERS

ADJUSTABLE VOLUME,
BASS AND TREBLE.
IR REMOTE CONTROL
12V - 20V DC INPUT



SOLD IN PAIRS

SERIES MODELS

ACTIVE STEREO AMPLIFIER SPEAKER PAIR WITH REMOTE CONTROL

High performance premium sound with convenience and flexibility. Connect any low-level line device to these speaker via RCA/3.5mm for instant HiFi sound. Push-button adjustable Volume, Bass and Treble with external remote control. Powerful polypropylene 5" woofer & dynamic tweeter driven by a very efficient class D high power 40Wrms built in amplifier module for excellent sound reproduction and control. Ideal for many applications. Manufactured using durable and high quality components for IP51 weather resistance and aluminium grilles for long life with no discolouration. Includes adjustable wall / ceiling mounting bracket. Includes external 20Vdc 3A switch-mode in-line power pack for maximum wattage. These speakers will also run on DC from 12Vdc to 20Vdc (effects wattage output).

Code	ADS5A40BK
Colour	Black
Input	RCA
Pmax	40W
Prms	20W
Freq.	60Hz-20Khz
Sens.	85dB
Packaging	Pair

Note. Voltage input varies power output:
12V Input: 10W rms / 20W max per channel (External 12V Power Source)
20V Input: 20W rms / 40W max per channel (Included 240V Power pack)

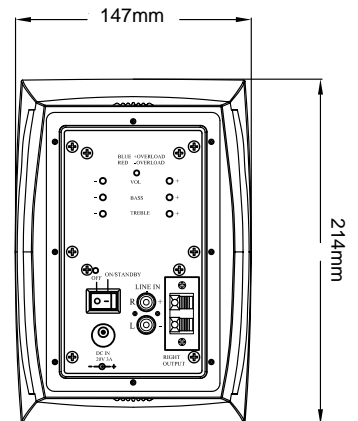
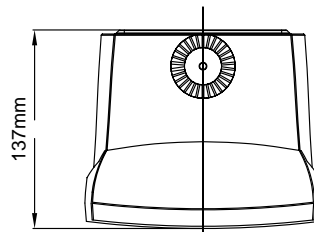

ATMOSPHERE
INDULGE YOUR SENSES
SOUND AMBIENCE FOR
ENHANCED ENJOYMENT

ACCENTO DYNAMICA SPEAKERS DELUXE 8Ω & 100V

2-WAY SPEAKER SYSTEM

Dynamic Mylar Tweeters (8" model has a silk dome). Large magnet powerful polypropylene woofers with butyl rubber surround in a sealed box. Flexible input options allow these speakers to be connected to 8 Ohm HiFi Audio system or 100V PA Audio System delivering outstanding quality.

INDOOR / OUTDOOR SPEAKERS

Premium grade materials and construction. Superior sound reproduction, high performance, multi-purpose speakers. Ideal for outdoors under awnings / eaves, use indoor as satellite hifi speakers and multi-room audio. High quality construction. Weather resistant sturdy plastic cabinet. Modern styling and attractively finished. Free-standing bookshelf or desktop. Metal wall mounting angled bracket. Quick and easy push-fit speaker wire terminals.

CONTEMPORARY

Superior sound reproduction performance. 2 Way system with Dynamic Mylar Tweeters. Large magnet powerful polypropylene woofers. Butyl rubber surround in a sealed weather resistant sturdy plastic cabinet. Colour Coated metal grilles (removable). Free-standing or mounting angled bracket.



SOLD IN PAIRS

SERIES MODELS

3½" 8Ω HiFi

Code	ADS3021B	ADS3021W
Colour	Black	White
Size	3.5"	3.5"
Input	8Ω	8Ω
Pmax	50W	50W
Prms	30W	30W
Freq.	85Hz-20KHz	85Hz-20KHz
Sens.	85dB	85dB
Packaging	Pair	Pair

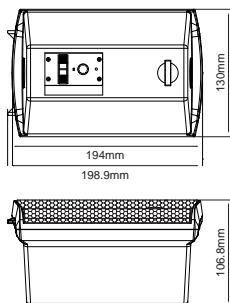

5" 8Ω HiFi & 100V

Code	ADS5021B-T	ADS5021W-T
Colour	Black	White
Size	5"	5"
Input	8Ω / 100V Taps 30W / 15W / 10W / 5W	8Ω / 100V Taps 30W / 15W / 10W / 5W
Pmax	60W	60W
Prms	30W	30W
Freq.	80Hz-20KHz	80Hz-20KHz
Sens.	86dB	86dB
Packaging	Pair	Pair

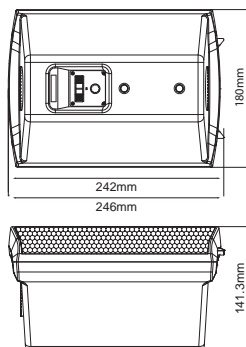

8" 8Ω HiFi & 100V

Code	ADS8021B-T	ADS8021W-T
Colour	Black	White
Size	8"	8"
Input	8Ω / 100V Taps 60W / 30W / 15W / 10W	8Ω / 100V Taps 60W / 30W / 15W / 10W
Pmax	120W	120W
Prms	60W	60W
Freq.	75Hz-20KHz	75Hz-20KHz
Sens.	88dB	88dB
Packaging	Pair	Pair

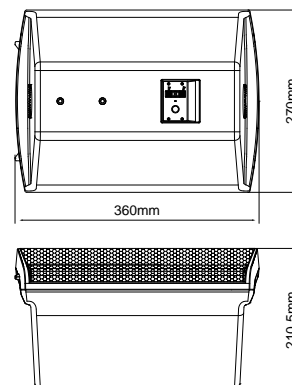

STYLE
AUDIO SOLUTIONS
FOR ANY DECOR



ACCENTO DYNAMICA

SPEAKERS HEAVY-DUTY IP55 8Ω & 100V

IP55 OUTDOOR SPEAKER ENCLOSURES

New fully sealed enclosure range, designed for extended life outdoors exposed to the elements & weather. Tested IP55 Waterproof rating. Attractive, quality ABS plastic. Made from UV resistant materials. Powder coated metal grille and adjustable mounting brackets. 2 Way system with mid-woofer mica reinforced polypropylene, butyl rubber roll surround. Large magnet with vented high power core. Mylar dome dynamic tweeter. Free-standing or wall mounted. Attractive and stylish design. Mounts vertically or horizontally.

WATER-PROOF SEALED WIRING LOOM

Rear terminals remain sealed by use of a screw type plug & 1ft lead. For 100V transformer taps, simple connect to the appropriately coloured wire.

FLEXIBLE INPUT OPTIONS

Optionally available in standard HiFi 8 Ohm for direct connection to a home stereo system OR with in-built multi-tap 100V line transformer for professional PA type applications. Available in arctic white box & grille or midnight black to suit your decor. Contemporary cabinets are modern and attractive that is stylish & unobtrusive. Sold in pairs with wall mounting brackets.



SOLD IN PAIRS

SERIES MODELS

5" 8Ω HiFi

Code	ADS5130W
Colour	White
Size	5"
Input	8Ω
Pmax	80W
Prms	40W
Freq.	67Hz-20KHz
Sens.	86dB
Packaging	Pair

5" 8Ω HiFi & 100V

Code	ADS5130BT	ADS5130WT
Colour	Black	White
Size	5"	5"
Input	8Ω / 100V Taps 30W / 15W / 7.5W	8Ω / 100V Taps 30W / 15W / 7.5W
Pmax	60W	60W
Prms	30W	30W
Freq.	67Hz-20KHz	67Hz-20KHz
Sens.	86dB	86dB
Packaging	Pair	Pair

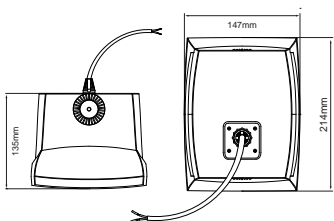

6½" 8Ω HiFi

Code	ADS6200B	ADS6200W
Colour	Black	White
Size	6.5"	6.5"
Input	8Ω	8Ω
Pmax	120W	120W
Prms	60W	60W
Freq.	58Hz-20KHz	58Hz-20KHz
Sens.	87dB	87dB
Packaging	Pair	Pair

6½" 8Ω HiFi & 100V

Code	ADS6200BT	ADS6200WT
Colour	Black	White
Size	6.5"	6.5"
Input	8Ω / 100V Taps 40W / 20W / 10W	8Ω / 100V Taps 40W / 20W / 10W
Pmax	80W	80W
Prms	40W	40W
Freq.	58Hz-20KHz	58Hz-20KHz
Sens.	87dB	87dB
Packaging	Pair	Pair

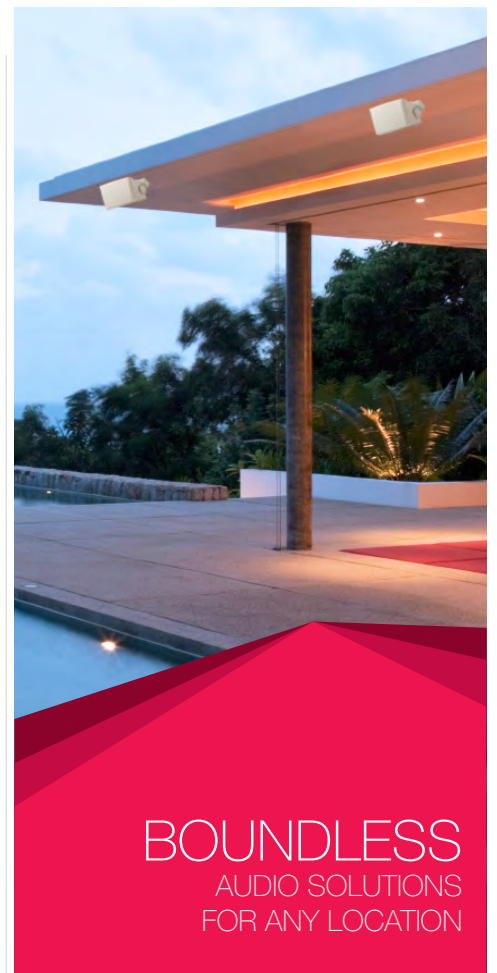
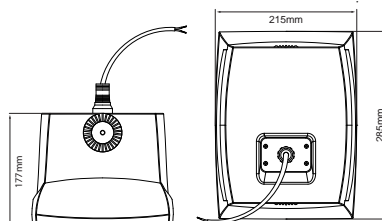

BOUNDLESS
AUDIO SOLUTIONS
FOR ANY LOCATION

CLASS-D AMPLIFIERS ACCENTO DYNAMICA

CLASS-D AMPLIFIERS

These ultra efficient amplifiers are next generation to produce excellent quality in sound. They are quite compact and yet still deliver powerful, clear and vibrant audio that compares to the larger classic linear type amplifiers making them ideal for home or desk-top, as these amplifiers offer a modern contemporary and practical alternative.



SOLD WITH POWER PACKS

SERIES MODELS

30W Compact



- Palm-size Class-D 30 watt amplifier
- Battery option for portability (6x AA)
- Includes AC powered power supply
- 90% Amp efficiency for longer battery life
- Superior sound quality for a mini-amplifier
- Blue LED and Volume with power switch
- Soft turn-on eliminates speaker pop
- CE and RoHS rated design
- Intelligent short-circuit protection
- Intelligent over-temperature protection
- Connects to any passive 4/8Ω speakers
- 3.5mm standard audio line stereo input

Code	ADA30
Power	2x 15Wrms
Input	2x RCA
Output	4-wire signal output. Bare-wire or 4mm
Vmin	12Vdc
Freq.	20Hz - 20kHz
Noise	102dB
Weight	225g
Dimensions	150x50x90mm



40W Optional Bluetooth



- Class D amp combines fidelity with efficiency
- High power in a convenient compact package
- Simple operation with an on/off switch & volume
- Quality metal case black anodised extruded aluminium with thick brushed front fascia panel
- Non-scratch rubber feet for desktop use
- RCA Stereo line level gold-plated input
- Bare-wire or 4mm speaker connection terminals
- Includes 15Vdc 2A power supply included
- TDA Series BTL Class-D chipset from ST
- Small size lets you use this amp almost anywhere
- Optional Bluetooth streaming model available

Code	ADA40	ADA40BT
Power	2x 20Wrms	
Input	1x RCA(L/R)	1x RCA(L/R), Bluetooth
Output	Speaker Wire Bare-end or 4mm	
Vmin	15Vdc	
Freq.	20Hz - 20kHz	
Noise	103dB	
Weight	320g	
Dimensions	90x40x120mm	



120W Big On Power



- STA508 chipset Audiophile-quality sound
- Compact modern style & minimal decor impact
- Ultra-quiet 103 dB signal to noise ratio
- 40Wrms (8Ω), 60Wrms continuous into 4Ω
- Rear gold-plated RCA inputs
- Front-mounted gold-plated 3.5mm input (over-rides)
- Gold-plated speaker connections (wire or 4mm)
- 6.35mm Headphone gold-plated output socket
- Compact extruded aluminium heat sink enclosure
- Thick, stylish black-anodized aluminium face plate
- One simple control: Volume pot with Off position
- Short circuit, thermal, and overload protection

Code	ADA120
Power	2x 60Wrms
Input	2x RCA
Output	4-wire signal output. Bare-wire or 4mm
Vmin	24Vdc
Freq.	20Hz - 20kHz
Noise	103dB
Weight	540g
Dimensions	50x86x160mm



TUBE HYBRID AMPLIFIER 24W BLUETOOTH® ACCENTO DYNAMICICA

accento
dynamica



PREAMP VACUUM-TUBES

Processes the analogue input signal to give a classic tube sound and warmth to your audio

FLEXIBLE INPUT OPTIONS

Supports audio input from Bluetooth, USB and RCAx 2 inputs. Output to headphones or speaker for 12Wrms per channel

SERIES MODELS

TUBE PREAMP & 12W CLASS-AB TRANSISTOR AMP WITH BLUETOOTH & USB PLAYER

The compact Accento-Dynamica hybrid is a German designed amplifier with a high quality sound for a low price. It is ideal for running modern book-shelf type speakers. Compact dimensions, fine design and of course great sound from a small attractive unit. Inputs include 2x RCA for a CD or Media player, plus Bluetooth V4.2 signal reception as well as a built-in USB audio player (supports MP3, WAV, APE, FLAC with Play/Pause/FF/REW) for modern connectivity and playback. The unit comes with 4mm speaker outputs for 4/8 ohm speakers as well as headphones 3.5mm, plus an RCA line-level output for an external active subwoofer if desired. There are two visible 6F2 tubes, which process the signal input and give a classic tube audio warmth to the sound (<0.1%THD) with Perspex finger guard and blue LED lit. The power amplifier stage is a premium Class-AB true discrete (all transistors only) design for a classic high-end analogue audio sound. The inbuilt power supply is transformer based, not switch-mode, for better low-noise audio. Built into a sleek brushed-aluminium enclosure, it has an attractive appearance to adorn your desktop or bookshelf and give you excellent sound quality when matched with some high-end compact speakers to fill a small room with the beautiful sound of vacuume tubes.

- Audiophile quality sound, German design
- True discrete transistor power amplifier
- 12Wrms x2 (25Wmax.) into a 4ohm load
- Dual 6F2 preamplifier pentode tubes
- Less than 0.1% THD @ 12W
- Transformer power supply (not SMPS)
- Rear mounted RCA type inputs x2
- Bluetooth 4.2 with external antenna
- USB Memory stick playback
- Doubles as a headphone amplifier
- RCA mono subwoofer output
- Brushed aluminium housing, metal knobs

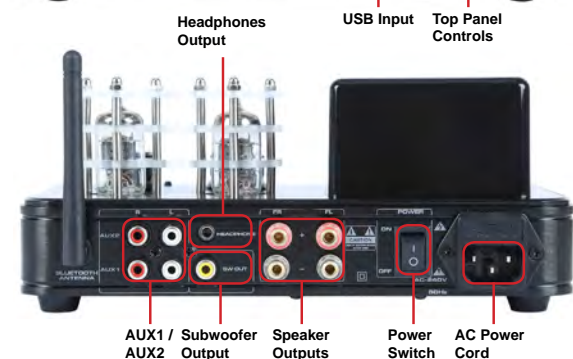

Product Code	ADHA24BT
Power Output	12Wrms x2 (4 ohms) 25Wmax x2
Total Harmonic Distortion	<0.1% @ 12W per channel
Minimum Speaker Impedance	4ohm
Frequency Response	20-20000Hz, ±2dB
Channel Separation	65dB
Dynamic Range	>80dB
Signal to Noise Ratio	>80dB

Preamplifier Tube	6F2 x2
Headphone Amp Output	15mW @ 600ohms; 11mW @ 300ohms; 7.8mW @ 32ohms; 5.6mW @ 16ohms
Bluetooth Version	4.2
USB Supported File Type	Supports MP3, WAV, APE, FLAC with Play/Pause/FF/REW
Input Impedance	47k ohm (min)
Input Sensitivity	300mV
Dimensions	235x155x110mm
Weight	2kg

TUBE HYBRID AMPLIFIER 90W BLUETOOTH® ACCENTO DYNAMICA

accento
dynamica

Bluetooth®



PREAMP VACUUM-TUBES

Process the input signal to give a classic tube audio warmth to the sound. With Bass & Treble controls.

POWER AMP TRANSISTORS

HiFi sound Class-AB output with ample power to drive any modern bookshelf or tower speaker system

FLEXIBLE INPUT OPTIONS

Supports audio input from analogue RCA (x2) Digital Coaxial or Optical input (DAC), plus Wireless Bluetooth, or USB Stick Media Player.

SERIES MODELS

4 TUBE PREAMP / 45WRMS CLASS-AB TRANSISTOR AMP BLUETOOTH / USB / DIGITAL & ANALOGUE INPUTS

The Accento-Dynamica hybrid amplifier is a German designed HiFi Amplifier with a high quality sound for a low price that is ideal for running modern, good quality, full sized speakers. Compact dimensions, fine design and of course great sound, the unit has 2 RCA inputs for DVD and CD, Digital inputs with Coaxial or Optical Toslink. The Bluetooth V4.2 signal reception as well as the built-in USB audio player (supports MP3, WAV, APE, FLAC with Play/Pause/FF/REW) for modern connectivity and playback. The unit comes with 4mm speaker outputs for 4/8 ohm speakers, plus an RCA line-level output for an external active subwoofer if desired. There are four visible tubes, which process the signal input and give a classic tube audio warmth to the sound (<0.1%THD) with metal chromium finger guards. The power amplifier stage is a premium Class-AB true discrete (all transistors only) design for a classic high-end analogue audio sound. The inbuilt power supply is transformer based, not switch-mode, for better low-noise audio. Built into a medium sized brushed-aluminium enclosure, it has an attractive appearance to adorn your desktop or bookshelf with excellent sound quality when matched with some high-end compact or full-sized speakers.

- Audiophile quality sound, German design
- True discrete transistor power amplifier
- 45Wrms (x2) 4Ω Class-AB transistor output
- 6U1 x2 6F2 x2 preamplifier pentode tubes
- 0.2% THD @ 45Wrms (x2)
- Transformer power supply (not SMPS)
- Rear mounted RCA type inputs x2
- Digital Coax & Toslink Inputs
- Bluetooth 4.2 with internal antenna
- USB Memory stick playback
- RCA mono subwoofer output
- Brushed aluminium housing, metal knobs

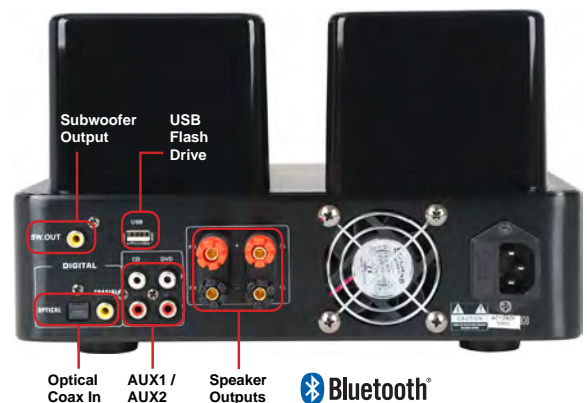

Product Code	ADHA90BT
Power Output	45Wrms x2 (4 ohms)
Total Harmonic Distortion	<0.1% @ 40W per channel
Minimum Speaker Impedance	4 ohm
Frequency Response	20-20000Hz, ±2dB
Channel Separation	50dB
Dynamic Range	>80dB
Signal to Noise Ratio	>90dB

Preamplifier Tube	6U1 x2, 6F2 x2
Subwoofer Output	RCA Single Line Level Output (2Vmax) Low Pass 100Hz 12dB/Octave
Bluetooth Version	4.2
USB Supported File Type	Supports MP3, WAV, APE, FLAC with Play/Pause/FF/REW
Input Impedance	47k ohm
Input Sensitivity	250mV
Dimensions	270(d)x293(w)x167(h)mm
Weight	5kg

TUBE HYBRID AMPLIFIER 160W BLUETOOTH® ACCENTO DYNAMICICA

accento
dynamica



PREAMP VACUUM-TUBES

Process the input signal to give a classic tube audio warmth to the sound. With Bass & Treble controls.

POWER AMP TRANSISTORS

Premium audio quality Class-AB output with high power to drive any modern full-sized speaker system

FLEXIBLE INPUT OPTIONS

Supports audio input from analogue RCA (x2) Digital Coaxial or Optical (DAC), Bluetooth V5.0, USB Stick Media Player or USB from PC.

HYBRID offers impressive sound quality by combining multiple vacuum tubes with a classic solid-state Class-AB power amplifier, packaged in an attractive brushed aluminium enclosure. The ADHA160BT is a modern classic from analogue and 24bit 196KHz digital inputs to the high performance of a powerful 80Wrms transistor linear amplifier with low distortion.

SERIES MODELS

DSP CONTROLLED DAC, PC, BT & USB WITH REMOTE CONTROL USB DAC - STREAMING FROM WIN PC

The new Accento-Dynamica hybrid amplifier is a German designed HiFi unit that uses both tubes and solid-state. The tube circuits are exclusively used in the pre-amp section to give your audio that classic tube sound that generally softens today's digital sources giving a warmer, more emotional audio experience while listening in the soft glow of the tubes. The output stage is classic Class-AB for improved speaker driving performance and low distortion sound reproduction. Transistors are used in the output stage because they can generate more power with less heat and reliability issues. Large, dual toroidal transformers in the power supply are used for greater performance with ample power to drive any modern speaker system. The ADHA160BT gives you the best of both worlds in sound and technology while appearing very impressive in the brushed aluminium enclosure that looks truly like classic audio with analogue VU power meters and old-school LED display. Bass and treble controls are included plus a remote control for volume, source select and control of the media player. The unit has two RCA inputs for DVD and CD plus Digital inputs with Coaxial or Optical Toslink. Built-in USB audio player (supports MP3, WAV, APE, FLAC with Play/Pause/FF/REW). The USB can also be connected to a PC for streaming audio playback. Bluetooth V5 audio input for wireless audio streaming from a phone or tablet, etc. There is also Pre-Amp output (post tubes and volume) to Main Amp Input with RCA Connections. The unit comes with 4mm / bare-wire speaker connectors for 4 to 8 ohm speakers, plus there is an RCA line-level output for an external active subwoofer if desired. With impressive sound quality, high power, digital audio connections, all in an attractive enclosure, the ADHA160BT is a modern classic.

- Tube Preamplifier and regulator
- Class-AB power amp with 8x Transistors
- High output of 80Wrms x2 (4 ohm) 2% THD
- 20Hz to 20KHz, SNR 90dB
- DSP DAC 44.1-192KHz 24 bit
- USB Input (PC) standard drivers
- USB stick MP3, WMA, FLAC player
- Coax and Toslink Optical Inputs
- Bluetooth® V5.0 up to 250m
- Two line-level stereo RCA inputs
- Bass and Treble controls
- Tube-pre out to Main amp input
- 2.1 with single RCA subwoofer out
- Temperature controlled fan
- Remote control Volume & Source
- Old school LED display
- Dual analogue VU meters
- Two heavy-duty toroidal transformers
- Brushed aluminium enclosure
- 330(d)x315(w)x165(h)mm 7.3Kg



Product Code	ADHA160BT
Power Output	80Wrms x2 (4 ohms)
Total Harmonic Distortion	<2% @ 80W per channel
Minimum Speaker Impedance	4 ohm
Frequency Response	20-20000Hz, ±1dB
Channel Separation	83dB
Dynamic Range	>85dB
Signal to Noise Ratio	>90dB

Preamplifier Tube	6U1 x2, 6A2 x2, 6H2 x2, WY-3P x1
Subwoofer Output	RCA Single Line Level Output (2Vmax) Low Pass 100Hz 12dB/Octave
Bluetooth Version	5.0 (AAC, SBC)
USB Supported File Type	Supports MP3, WAV, APE, FLAC with Play/Pause/FF/REW
Input Impedance	47k ohm
Input Sensitivity	550mV
Dimensions	330(d)x315(w)x165(h)mm
Weight	7.3kg

40W KARAOKE AMPLIFIER - ACCENTO DYNAMICA



CONVENIENT FRONT PANEL MIC INPUTS
Dual microphone inputs on the front panel allows you to plug in your mics with ease. With mic volume and echo control.

POWER AMP TRANSISTORS
Premium Class-AB true discrete design for a classic high-end analogue audio sound.

FLEXIBLE INPUT OPTIONS
Supports audio input from Aux/Phono, Bluetooth, USB Stick Media Player and 2x Mics.

SERIES MODELS

BLUETOOTH / MEDIA PLAYER / PHONO / MICROPHONE

Accento Dynamica ADA41BT is a versatile compact amplifier designed for quality HiFi audio sound reproduction. It offers 20W of RMS power per channel @ 4Ω delivered by genuine Toshiba C5198/A19414 transistor Class-AB output. Quality power supply for better audio with toroidal transformer and separate digital/analogue regulator filter circuits. Comes equipped with RCA input that can be switched from standard Line-level to phono RIAA input for a turntable. Have a Karaoke party with the two 6.35mm Mic inputs on the front panel with adjustable mic level and echo. The front panel has a master volume with balance plus bass and treble tone controls. A loudness switch changes the over-all amplifier sensitivity for a higher gain ideal for boosting output. USB socket for external memory stick to playback stored media with pause/next/previous controls. Bluetooth V4.0 enabled for wireless streaming from your mobile device. External antenna for stable reception. The rear panel has 4x Bare-wire or 4mm speaker connection terminal outputs for 4Ω or 8Ω speakers. All metal cabinet and extruded aluminium front panel with an attractive brushed finish. 250x42x240mm

- Toshiba transistor Class-AB amplifier stage
- Quality HiFi 20Wrms per channel @ 4Ω
- High power toroidal power transformer 240Vac
- All metal case, brushed aluminium front panel
- Two microphone inputs with level and echo
- USB media playback with controls
- Bluetooth V4.0 streaming audio input
- Phono preamplifier input for turntables
- Line-level source RCA Stereo input
- RCA subwoofer out (pre volume control)
- Bass and treble tone controls
- Loudness sensitivity switch
- Wire/4mm speaker terminals
- Non-scratch rubber feet
- Compact 250x42x240mm

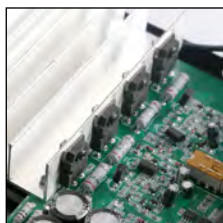
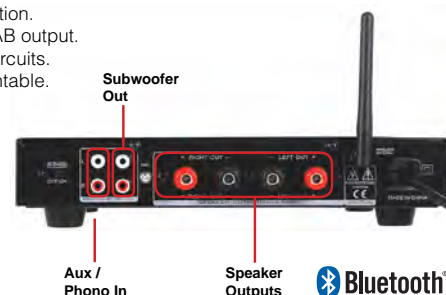

Class AB amplifier stage



Convenience 2x front microphone inputs with level and echo



RIAA Phono pre-amplifier to support turntable input



Toroidal power transformer

Product Code	ADA41BT
Power Output	20Wrms x2 (4 ohms)
Total Harmonic Distortion	<1%
Minimum Speaker Impedance	4 ohm
Frequency Response	20-20000Hz
Channel Separation	50dB
Signal to Noise Ratio	>85dB
Subwoofer Output	RCA Single Line Level Output

Bluetooth Version	4.0
USB Supported File Type	Supports MP3, WAV, FLAC with Play/Pause/FF/REW
Mic Sensitivity	10mV
Dimensions	248(d)x270(w)x50(h)mm
Weight	2.2kg

140W INTEGRATED STEREO AMPLIFIER WITH BLUETOOTH 240V - ACCENTO DYNAMICICA

accento
dynamica



POWER AMP TRANSISTORS

Premium audio quality Class-AB output with high power to drive any modern full-sized speaker system.

FRONT PANEL OUTPUT CONTROLS

Includes master volume bass, treble and balance knobs.

BUILT-IN DIGITAL TO ANALOGUE CONVERTER

The onboard DAC supports digital signal up to 24bits/96kHz from coaxial and optical inputs.

FLEXIBLE INPUT OPTIONS

Supports 6 different audio inputs including 1x Phono RCA, 2x Line RCA, Coaxial, Optical, Bluetooth V4.0, and MP3 (front 3.5mm AUX). Comes with remote control to select source input with ease.

SERIES MODELS

SUPPORTS INPUTS FROM PHONO / LINE / DIGITAL / BLUETOOTH SOURCES

Accento Dynamica ADA140BT is a versatile home stereo amplifier designed for quality HiFi audio sound reproduction. It offers 70W of RMS power per channel @ 4Ω delivered by high power, classic transistor type Class-AB output. Quality power supply for better audio with toroidal transformer. Shielding for the sensitive preamp audio section. The main PCB uses old-school through-hole componentry with all driver and output transistors heat-sinked. Equipped with six inputs, ample for most home audio setups, ideal for those who want a quality stereo amplifier. Two RCA Stereo Line-level inputs plus a phono RIAA preamplifier input for spinning your classic vinyl records. Bluetooth V4.0 enabled for wireless streaming from your mobile device. Removeable antenna for stable reception. Direct digital inputs: Toslink optical and coaxial for PCM decoding up to 24bit/96kHz DAC high-definition audio. There are two sets of RCA outputs. One is record out line level. The other is post volume for an active subwoofer. Front panel has a convenient 3.5mm stereo input for MP3 players, etc. Headphone jack 6.35mm with speaker mute. The rear panel has gold-plated Bare-wire or 4mm speaker connection terminal outputs for 4Ω or 8Ω speakers. Tone controls Bass and Treble with a Direct switch for bypassing. Loudness button a high/low frequency boost. Handy remote control for power, source select and adjusting the motorised volume knob. Plus Bluetooth controls. All metal cabinet and extruded aluminium front panel with an attractive brushed finish. 430x82x345mm 6.2Kg.

- Classic HiFi stereo Class-A/B amplifier topology
- 2x 70W per channel @ 4Ω, 2x 45W per channel @ 8Ω
- Circuit design and layout to optimise dynamic range
- Front controls for volume, treble, bass, balance, source
- Includes Remote Control with motorised volume knob
- 2x RCA Stereo line level inputs, 1x Phono RCA input.
- Supports digital Optical / Coaxial inputs 24bit/96kHz DAC
- Supports 1x MP3 input (via front panel 3.5mm socket)
- Supports Bluetooth audio streaming from a mobile device
- Bare-wire or 4mm connection terminals to loudspeakers
- 1x RCA (L/R) Line output and 1x RCA (L/R) REC output.
- Quality metal case, brushed anodised aluminium front panel
- Large Non-scratch rubber lined feet. 430x82x345mm 6.2Kg



Class AB amplifier stage



Built-in digital to analogue converter with digital signals up to 24bits/96Hz



Motorised Volume Control

Product Code	ADA140BT
Power Output	70Wrms x2 (4 ohms), 45Wrms x2 (8 ohms)
Minimum Speaker Impedance	4 ohm
Frequency Response	20-20000Hz
Signal to Noise Ratio	>93dB
Bluetooth Version	4.0
Phono Input Impedance	47k ohm
Dimensions	430(d)x345(w)x82(h)mm
Weight	6.2kg



Distributed By:



WES AUSTRALASIA

Email: sales@wes.net.au - Web: www.wes.net.au
Phone: 02 9797 9866 - Fax: 02 9716 6015

Address: 84-90 Parramatta Road, Summer Hill, NSW 2130