

2-WAY REFERENCE MONITOR SYSTEM

Model: BR-1

Construction Workbook

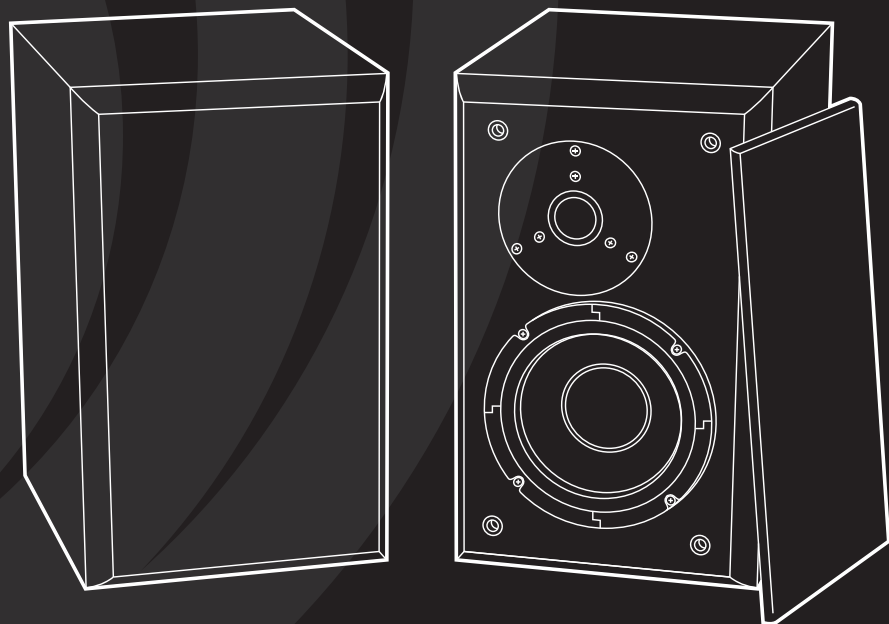

Congratulations on your purchase of the Dayton Audio® BR-1 2-Way Reference Monitor Speaker System. Features of this kit include an elegant design, quality components, detailed assembly instructions, and an in-depth design tutorial.

The BR-1 Speaker Kit can be built in only a few hours using basic hand tools and electronic supplies. Once you've completed this speaker project you will have learned the basics of speaker design and construction and have speakers that will provide you with fantastic sound for years to come.



Parts Inventory

Carefully unpack the kit, take inventory of all parts and make sure that nothing was damaged during shipping. Your BR-1 Reference Monitor System should include the following:

Model #	Qty	Description
BR-1CAB	1	Dayton Audio BR-1 Cabinet Pair
DC160-8	2	Dayton Audio 6-1/2" Woofers
DC28F-8	2	Dayton Audio 1-1/8" Silk Dome Tweeters
BR-1XO	2	Crossover Boards
47uF-100V	2	47uF-100V Non-polarized Capacitors (C3)
DFFC-0.10	2	Dayton Audio .1uF-400V By-Pass Capacitor (C3)
DNR-8.0	2	Dayton Audio DNR-8.0 8 Ohm 10W Non-Inductive Resistors (R1)
DMPC-3.0	2	Dayton Audio 3.0uF-250V Polypropylene Capacitors (C2)
1.5mH IND	2	1.5mH 18 Ga. Perfect Layer Inductors (L2)
DMPC-6.2	2	Dayton Audio 6.2-250V Polypropylene Capacitors (C1)
4 Ohm 5W	2	4 Ohm 5W Resistors (R2)
6.2 Ohm 5W	2	6.2 Ohm 5W Resistors (R3)
.4mH ACI	2	.4mH 20ga. Air Core Inductors (L1)
TCUP BR-1	2	Terminal Cups
16 Ga 6Ft	1	6' long 16 Ga. Sound King Wire
.205" 16-14	24	.205" (16-14) F-Disconnect 50 PCS.
Foam	2	Acoustic Foam 1-1/2" 24"x18"
8X34	8	#8 x 3/4" Phillips Pan Head (for woofer)
6X34	14	#6 x 3/4" Phillips Pan Head (for tweeter & cup)
MANUAL	1	BR-1 Instruction Manual

Background and Objectives

The objective when designing this system was to offer customers a great sounding, low cost kit that can be quickly and easily assembled while offering a basic lesson in speaker design. Although cost was a factor, the design must offer excellent performance. In short, a Budget *Reference* system. Hence the name Dayton Audio BR-1.

Many of you have a strong interest in building inexpensive loudspeakers, but do not possess the necessary test equipment to design from scratch. The BR-1 is an effort to provide an inexpensive kit that gets the most out of the chosen drivers.

Even though cost was a factor in the choice of components and in the final crossover design, the end result is quite satisfying. The design objective was met with flying colors. The overall sound is smooth and detailed, with a wide soundstage that belies their smallish size. The tonal balance is on the warm side of neutral, which is pleasing with most types of music. Bass also is impressive for a 6.5" driver, the F3 (Half power frequency in Hz) being around 43 Hz. Your BR-1s will perform well for living room, family room, or dorm room music listening or in your high end home theatre surround system.

The Drivers

Included in your kit are two each of the 6-1/2" Dayton Audio woofer and the Dayton Audio 1-1/8" silk dome tweeter. Both units are good candidates for this project. The woofer incorporates a treated paper cone, coupled to a rubber surround. The response is generally well behaved, but does exhibit a peak centered around 3.3KHz.

The Dayton Audio 1-1/8" silk dome tweeter is hands down one of the finest tweeters available in it's price range! The response exhibits some peakiness, and the driver seems to have a 'wandering' Fs, but the sound is on a par with tweeters that cost far more.

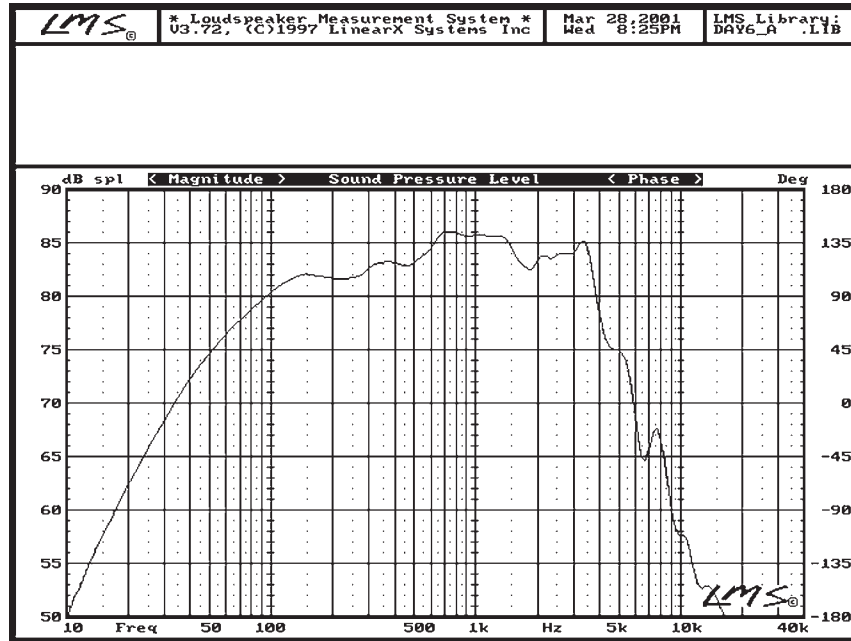

6.5" On Axis Frequency Response

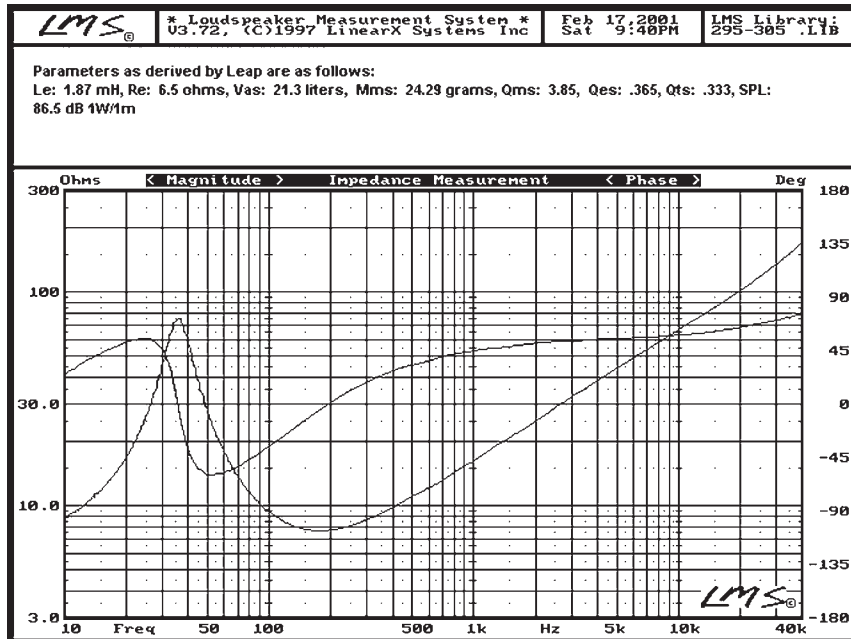

6.5" Impedance Sweep

The impedance is smooth, but due to the rather large amount of voice coil inductance, commonly known as a driver's L(e) rises sharply. Note in the 2KHz area, where this driver will be crossed over, the impedance is 25 ohms. For this reason, an impedance compensation network will be used, commonly known as a "Zobel Network".

About Zobel

This simple circuit consists of a single resistor and capacitor. It is commonly referred to as a Zobel network, named for the Bell Laboratories engineer who invented it. An excellent starting point can be calculated by using this formula.

$$R = 1.25 \times R_e$$

$$C = L_e / R^2$$



R_e is measured voice coil DC resistance in ohms.
 L_e is measured voice coil inductance in henries

R is in ohms

C is in farads

The 6-1/2" woofer parameters were measured using the LMS Loudspeaker Measurement System (a PC based package for measuring loudspeaker systems), and the L_e was found to be 1.87 millihenries. Using an accurate ohmmeter, the R_e was 6.5 ohms. Using the above formula:

$$R = 1.25 \times 6.5$$

$$R = 8.125 \text{ ohms}$$

so

$$C = .00187 / 66$$

$$C = .0000283 \text{ farads or } 28.3 \text{ uF}$$

Although these values will give a good result, actual in box impedance measurements indicated an even better compensation can be had with a 47uF capacitor and a 8 ohm resistor.

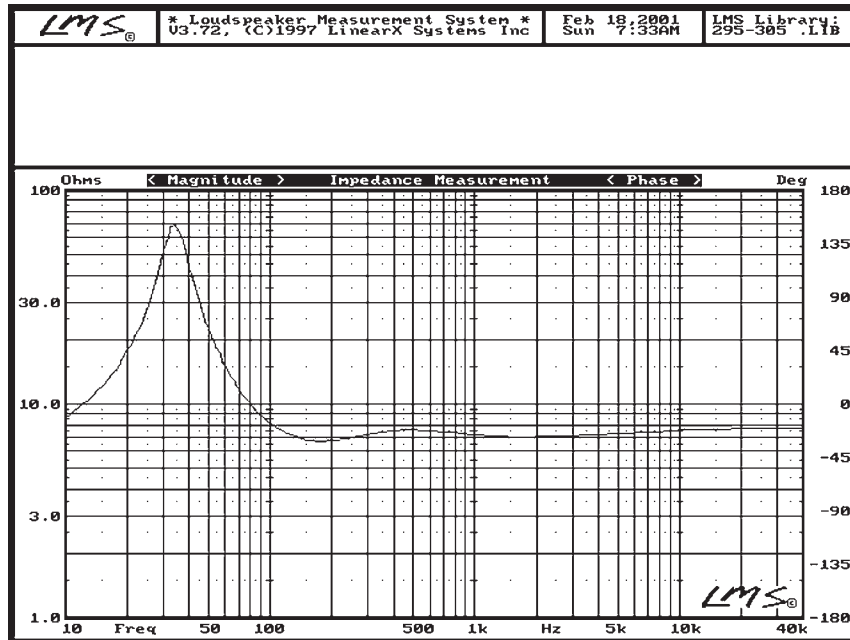
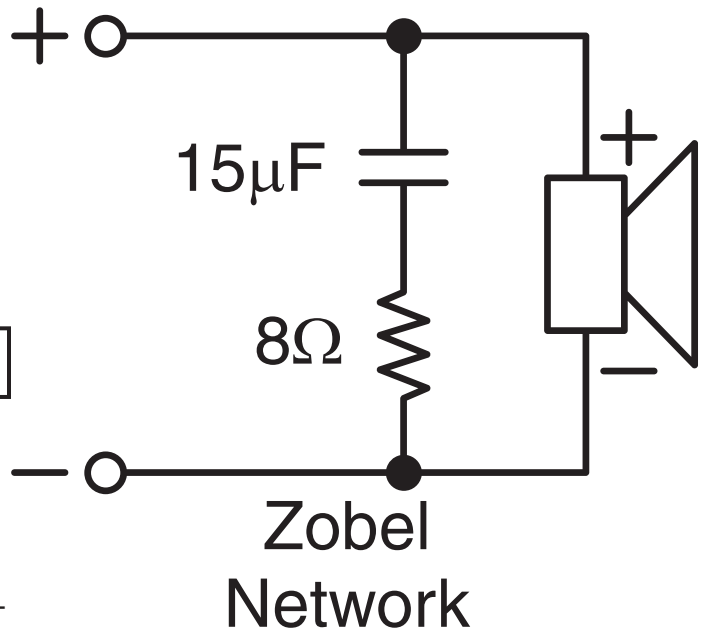

6.5" Impedance w/ Zobel Network

As can be seen on the graph above, the impedance is now very flat through the crossover region. From 250 Hz to 10 KHz, the impedance is 7 ohms +/- 0.5 ohm.

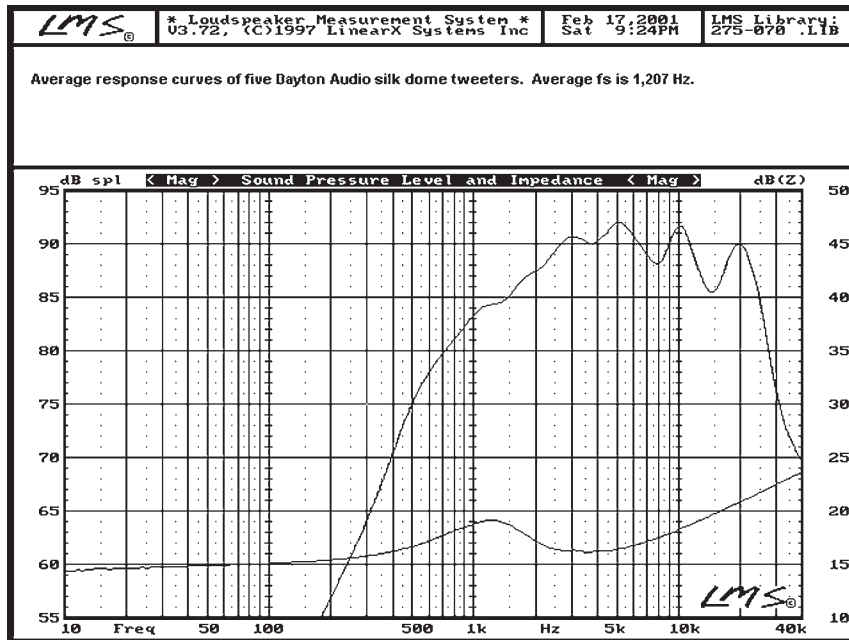

1-1/8" Dome On Axis Frequency Response and Impedance Sweep

The Crossover Network and Description

Here is the BR-1 crossover schematic.

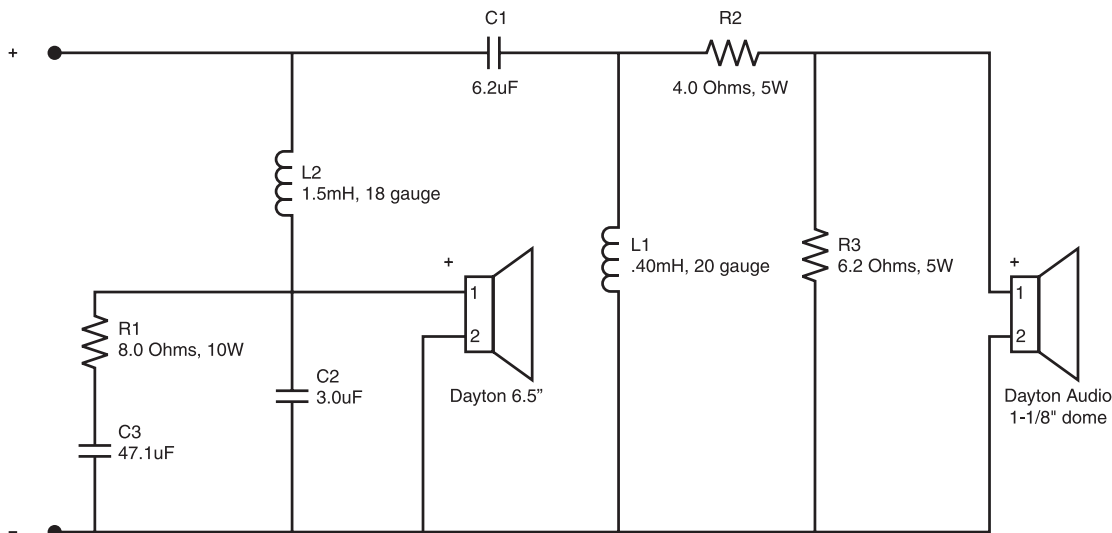

Dayton Audio BR-1 Crossover

The low pass filter is a four element filter. L2 and C2 form an electrical 2nd order filter (a filter using 2 components to yield an approximate 12dB per octave roll-off) and yields a 2nd order acoustic response. The impedance compensation circuit consists of C3 and R1 which effectively flattens the woofer's inductive rise, yielding a smooth impedance curve.

C3 is actually two capacitors, one a 47uF non-polarized electrolytic, with a .10uF Dayton Audio film/foil capacitor wired in parallel. The reason? NP electrolytics are very cost effective, but exhibit high ESR (Equivalent Series Resistance) and also have some inductive components. Using a small value high quality capacitor placed in parallel with the electrolytic will also parallel the undesirable resistance and inductance, thus reducing them greatly. This method is called bypassing.

The high pass filter is comprised of C1 and L1, and is also a electrical 2nd order yet it yields approximately a 3rd order acoustic response. R2 and R3 attenuates the tweeter's output 6 dB to match the woofer's level.

Most loudspeakers, including the BR-1, use drivers mounted on a flat baffle. One problem encountered here is the fact that the tweeter's relative acoustic center is set ahead of the woofer's relative acoustic center. In general, a flush mounted tweeter's acoustic center is aligned with the front baffle. A typical 6-1/2" woofer's relative acoustic center, is set about 1-1/2" behind the tweeter. This means that when fed a signal at the crossover frequency, the woofer's output will be delayed 110uS relative to the tweeter. For successful filter summation, this must be dealt with.

The method used to compensate for this delay in the BR-1 is the use of asymmetrical filters. Normally one would use the same crossover topology for both high pass and low pass filters. A 3rd order high pass acoustic slope is used with a 2nd order low pass acoustic slope to allow for the time delay. This technique takes advantage of the phase delay differences between the two filter types and results in a flat summation and allows both drivers to be acoustically in-phase with one another at the crossover frequency.

The crossover filters were designed to achieve a flat overall response. The BR-1 measures on axis within +/- 2.0dB from 100 Hz -12 KHz. Flat frequency response is desirable so that all frequencies are reproduced with the same loudness over the loudspeaker's bandwidth. In itself, flat frequency response does not ensure a good sounding loudspeaker. But targeting flat on axis performance, is the first step in designing a high performance loudspeaker.

Another, arguably more important goal is flat off axis frequency response. Many times a speaker can measure flat on axis, but the off axis curves suffer from dips in the response. This is due to insufficient driver overlap, usually caused by using too high of a crossover point for the low frequency driver. Good off axis performance, will avoid the so-called Venetian blind effect. What is the Venetian blind effect? When the seated listener moves horizontally from directly in front of the speaker, the treble or high frequency response drops off dramatically. A loudspeaker which exhibits good off axis response can be listened to well away from directly in front of the speakers and excellent performance will still be enjoyed.

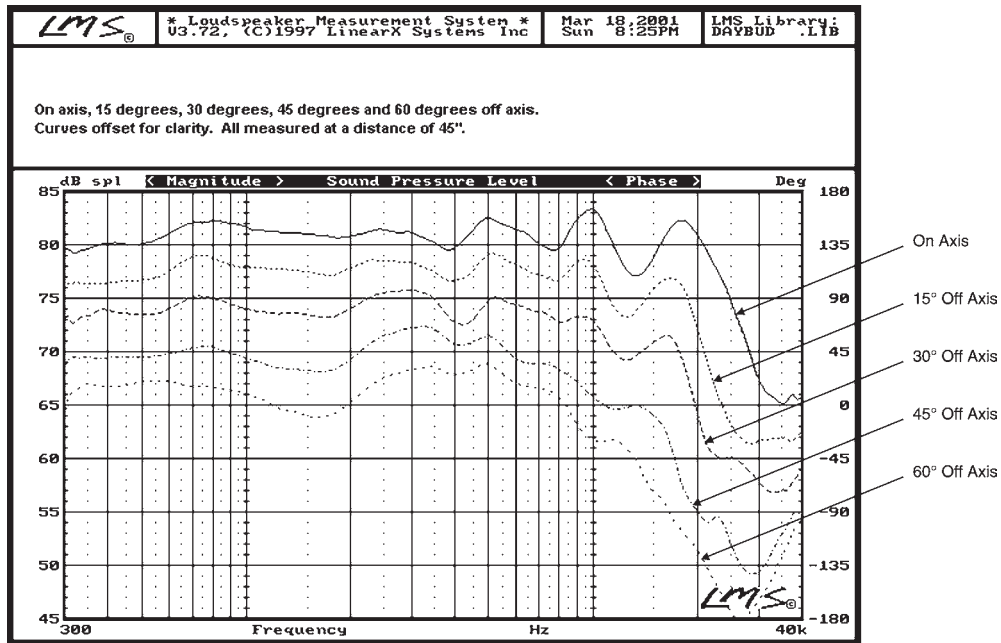

On/Off Axis Response of BR-1 System

Note that even 60 degrees off axis, the woofer is producing a reasonably flat response without deep nulls or cancellations throughout the crossover region.

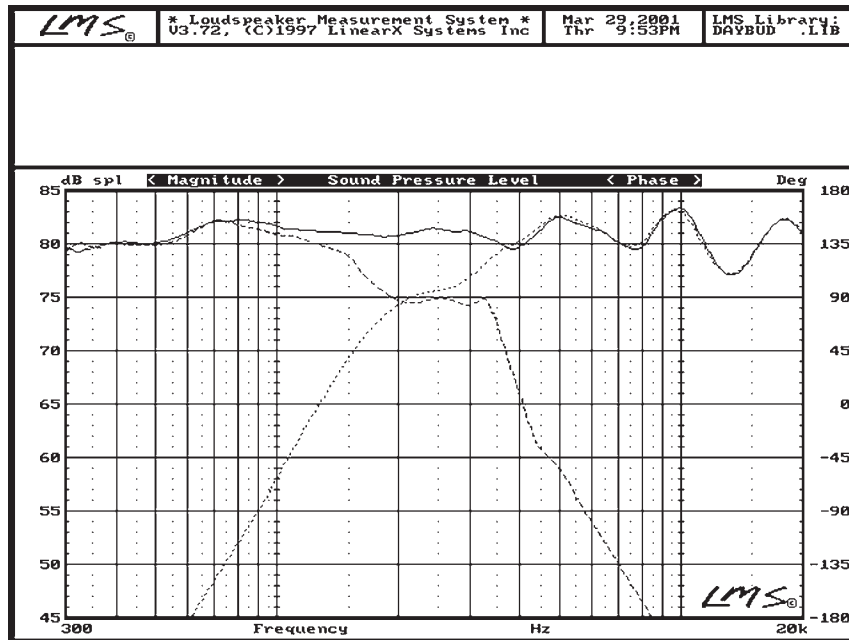

Individual Driver and Summed System Response

The above graph was produced with the microphone at a distance of 45", on the tweeter's axis. It was preferred to use the slightly farther than 1 meter (39.37") distance to be more in the far field, to get a better representation of how the drivers will blend. The response is within the +/- 2.0 dB window to 12KHz. In fact, the response is commendably flat from 300 Hz to 3.5KHz. It can be seen that the acoustic crossover occurs at 2.1KHz. These curves have been smoothed 1/6th octave.

The woofer's peak at 3,200 Hz is still present, and it should be noted that a parallel notch filter could be used in the low pass circuit to reduce it's effect. One was omitted to keep in the spirit of a low cost design, since this would add three more crossover components per speaker. The peak's audibility was found to be relatively benign however.

It's worth discussing the parallel notch filter because it is a handy circuit that is used to control frequency response peaks. A parallel notch filter consists of a capacitor, an inductor, and a resistor all wired in parallel with each other, then this circuit is placed in series with the driver.

For a 8 ohm woofer with a typical "peak" (about 5 dB), use the following formula for a starting reference...

$$C = 1 / (33 * \text{freq of peak})$$

$$L = .025 / (\text{freq of peak squared} * C)$$

With the 6-1/2" woofer, mounted on the BR-1 baffle, the peak is centered at 3,200 Hz. So ...

$$C = 1 / (33 * 3200)$$

$$C = .0000094 \text{ farads or } 9.4 \text{ uF}$$

$$L = .025 / (10240000 * .0000094)$$

$$L = .000259 \text{ henries or } .259 \text{ mH}$$

To find the value of R, you first must find the Q of the peak. Do this by finding the -3dB points on both sides of the peak. For the 6-1/2" woofer, these -3dB points are 2,500 Hz and 3,700 Hz. Now use this formula to calculate the peak's Q...

$$Q = \text{freq of peak} / (Fh - Fl)$$

$$Q = 3200 / (3700 - 2500)$$

$$Q = 2.67$$

We can now calculate the resistor value by:

$$R = Q / \text{square root of } C/L$$

$$R = 2.67 / \text{square root of } .0000094 / .000259$$

$$R = 14.05 \text{ ohms}$$

So the values for our proposed parallel notch filter is a 9.4uF capacitor, .26mH inductor, and a 14 ohm resistor. Unlike the impedance compensation filter discussed earlier, this filter is harder to generate from just design formulas. It is best to use some means of measurement to validate the result. Please note that adding this notch filter to the existing BR-1 crossover will change the filter roll off and will necessitate a low pass filter redesign.

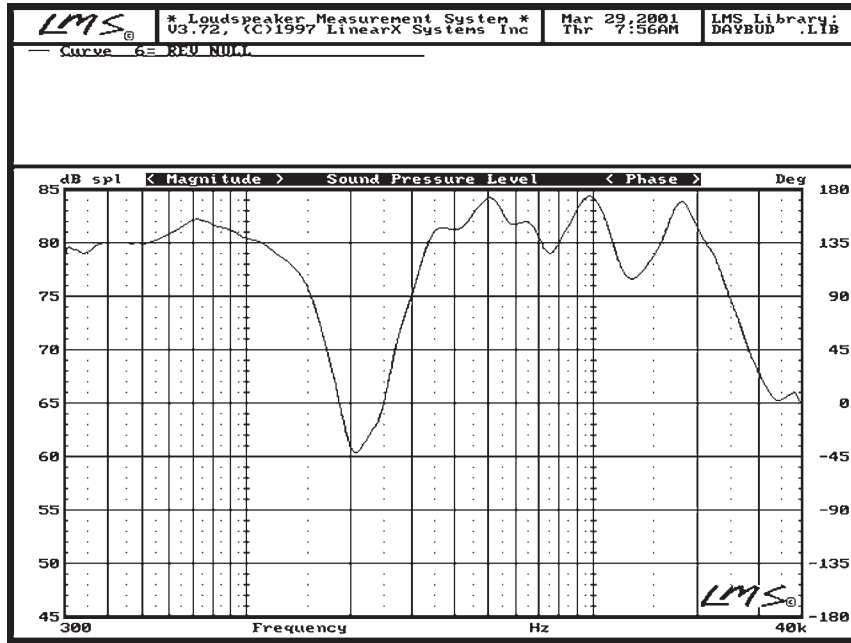

Reverse Tweeter Polarity

Reversing tweeter polarity is a quick check performed with even order filters to test the overall phase relationship that exists between the tweeter and woofer. The goal is to achieve a fairly deep, symmetrical null at the crossover frequency when the tweeter polarity is reversed. If one is witnessed when the tweeter polarity is reversed, then it can be assumed that a good phase relationship exists when the tweeter is connected with normal polarity.

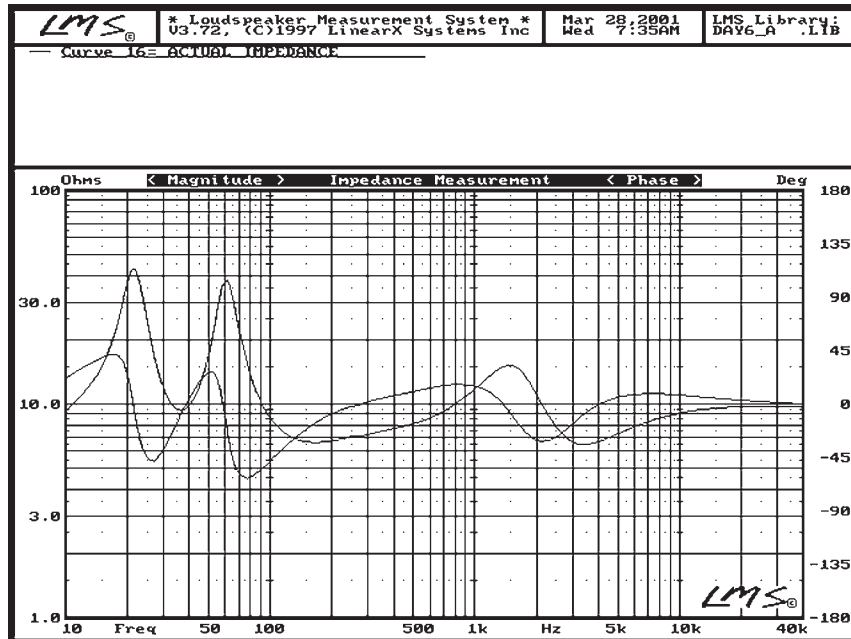

System Impedance and Phase

The system impedance and electrical phase is quite smooth, with a nominal 8 ohm impedance. This loudspeaker will be an easy load to drive for most any amplifier. However due to the 82.5 dB sensitivity, a minimum of 75 watts per channel is recommended.

The center to center driver spacing is 5-3/4", with the tweeter being offset 1" in a mirror image pair. The tweeter is flush mounted to the baffle, while the woofer is recessed only to the top of the basket. This was done due to the 5/8" thickness of the enclosure material.

The Cabinet

The Dayton Audio BR-1 cabinet uses 5/8" thick MDF and has an net internal volume of .52 cubic feet. It utilizes a EBS (extended bass shelf) alignment and is tuned to 38 Hz with a rear mounted port. This tuning results in a F3 of 43 Hz. The box dimensions are 8-5/8" wide, 14-1/4" high with a depth of 11", giving it a small footprint suitable for stand mounting. It is recommended to place the tweeter at, or slightly below ear height of a seated listener.



The center to center driver spacing is 5-3/4", which is an important consideration. Whenever you have two drivers combining output, as is encountered around the crossover frequency there will be some interference patterns. This interference will create dips and peaks to the frequency response. The greater the distance between the two drivers, the more intense this undesirable interaction.

The generally accepted maximum center to center distance between the two drivers is equal to one wavelength (13,560) at the proposed crossover frequency.

Max center to center distance = $13560 / \text{crossover frequency}$

So in the case of the BR-1:

Max CTC = $13560 / 2100$ or 6.45"

Since the tweeter to woofer distance is 5-3/4", the BR-1 is well within the one wavelength tolerance and will provide a uniform radiation pattern.

BR-1 Assembly Instructions

1) Installation Tools Needed

- Phillips screwdriver
- Hot glue gun or RTV sealant
- Soldering iron
- Silver or electronic grade solder
- Wire cutter / stripper
- Small pliers
- Crimp tool
- Utility knife

Crossover Assembly Note

! Warning!! The correct assembly and wiring of the crossovers is critical to the proper operation of this speaker system. In a worst case situation, an improperly wired network can damage your receiver or amplifier! Please double and triple check all values and wiring.

Assembling the Crossovers

1. Install all components on the boards in their proper location. When installing R1, position it so that air can circulate around its body. Before mounting (C3) to the p.c. board, it needs to be "bypassed". C3 is actually two capacitors, one 47mfd. electrolytic bypassed with a .10mfd Dayton Audio poly film/foil. This was done to improve the acoustics of the electrolytic capacitor. To bypass the capacitor, simply parallel the two capacitors together and wrap the smaller "poly" cap leads around the larger electrolytic cap leads and solder. Trim excess "poly" cap leads and use the electrolytic leads to mount the "bypassed cap" to the p.c. board.

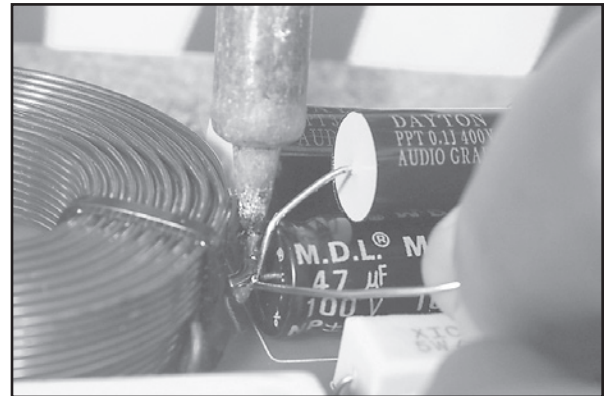
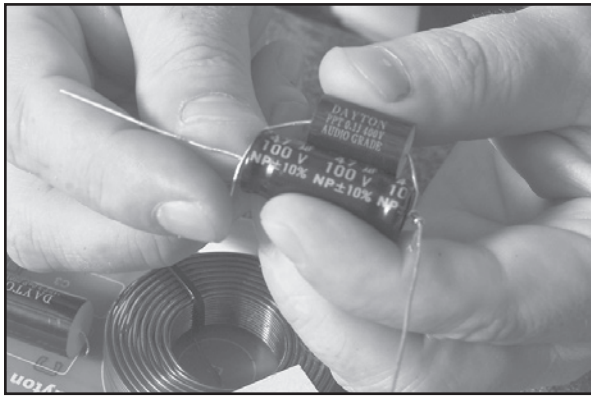

2. When positioning components, try to keep lead lengths to a minimum. Note: The (L1).40mH inductor should be mounted on its side to minimize the interaction between the two coils on the board. You can trim the length of the leads on the (L1) inductor without effecting its' value. Using a utility knife, scrape off the enamel coating on the trimmed lead ends so it will accept solder.

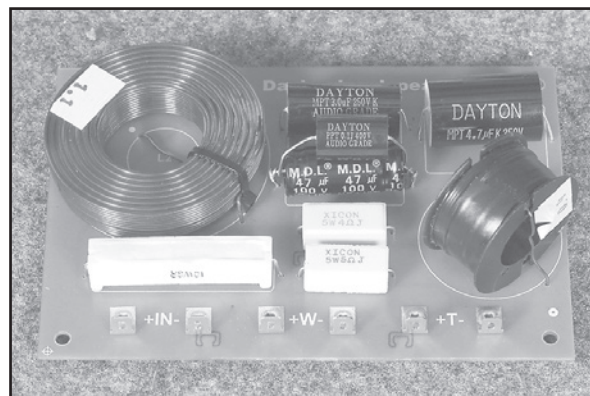

- To help reduce the risk of components rattling on the p.c. board, (especially the inductors) use RTV sealant or hot glue to mount the components to the p.c. board. We recommend using hot glue due to its faster setup time. If you use RTV sealant, you may need to let it setup over night, before proceeding with the assembly.



- Solder all component connections on the p.c. board using silver or electronics grade (60/40) solder. At this time, you should also solder the riveted .205 terminal connections. A properly soldered connection appears shiny and smooth. We recommend using a soldering iron with a wattage rating between 20-30watts. Using wire cutters, trim off all excess component leads.
- Cut the supplied wire into 6 pieces approximately 12" long. Strip the insulation on all wires back about 3/8"-1/2".

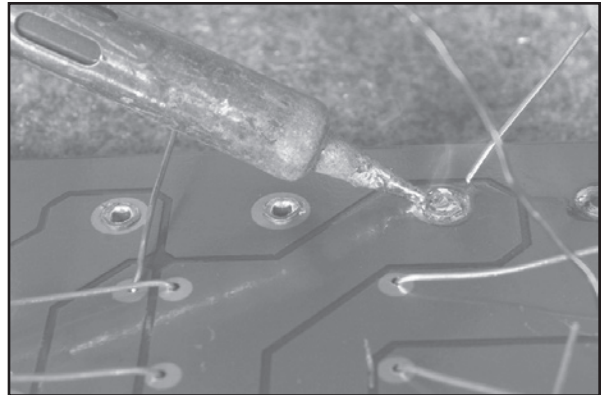

- Using a crimp tool, crimp the .205 terminals on the wire leads. To ensure a tight connection, gently squeeze the push on terminals with a small pair of pliers. Note: If you prefer, you can solder the wires directly to the p.c. board and drivers instead of using the connectors.

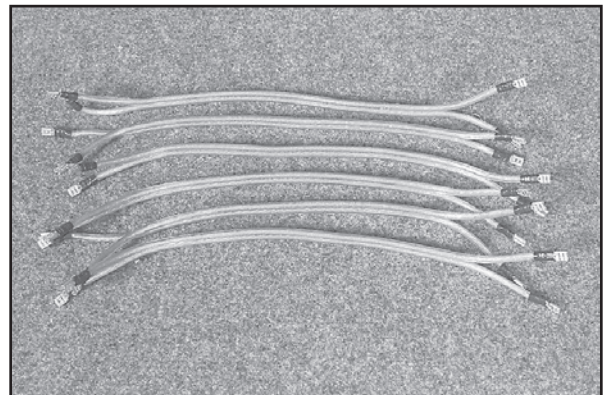
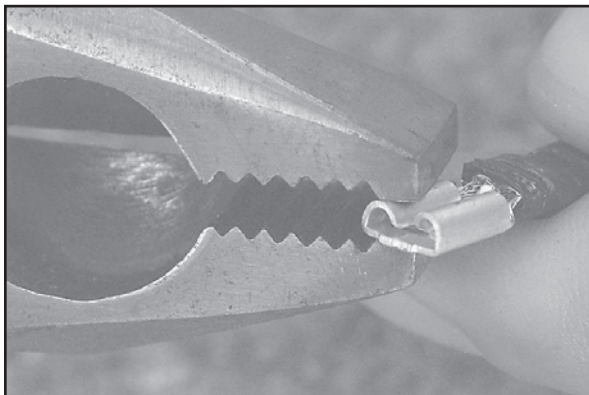
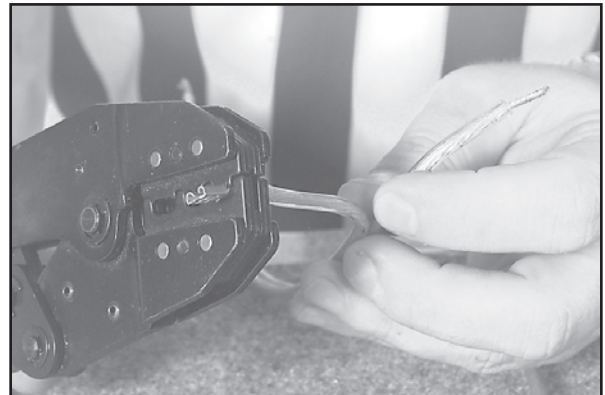

- The locations where the input and driver output wires connect, are clearly marked on the p.c. board. While observing proper polarity attach all input and driver wires to their respective mounting terminals. Example: To attach the input wire, take the positive (+) input wire and connect it to the "IN+" terminal. Next, take the negative (-) input wire and connect it to the "In-" terminal. Repeat this step for the woofer, tweeter and other crossover. Again, it is very important to observe the proper polarity!
- At this point, it is a good idea to label each wire to ensure proper hook-up. Masking tape and a marker will work fine.

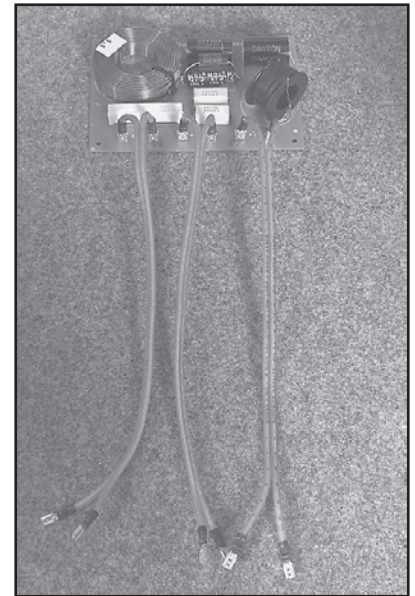

3) Cabinet Assembly Instructions

A. Installing the Crossovers

To mount the crossovers we recommend using hot glue due to its faster setup time. If you use RTV sealant, you may need to let it setup overnight, before proceeding with the assembly. You could also use screws, but they can be a little difficult to install and you run the risk of driving the screw through the finished side of the cabinet. *No crossover mounting screws are included.*

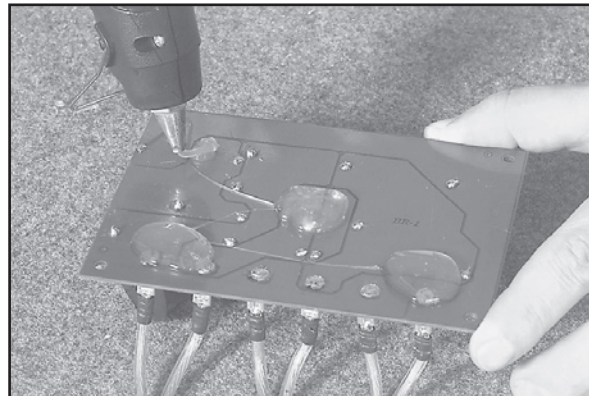

- Position the crossover board on the inside bottom of the cabinet against the back wall with the wiring facing outward.

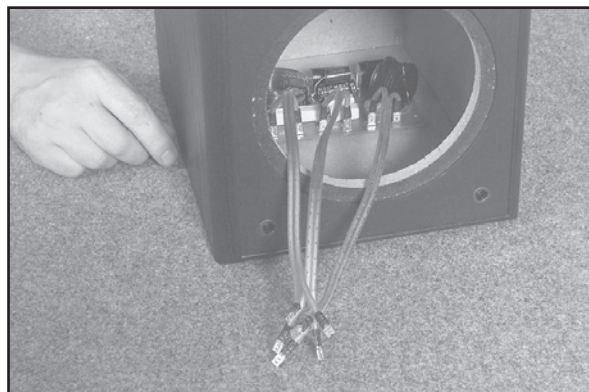

- Glue the crossover in place.

3. Pull the “labeled” input wire through the terminal cup hole and while observing proper polarity connect the wire to the terminal cup. **The positive (+) input wire should be connected to the “red” binding post.**
4. Orient the terminal cup with the binding posts toward the bottom and install using the small #6 screws and a phillips screwdriver.

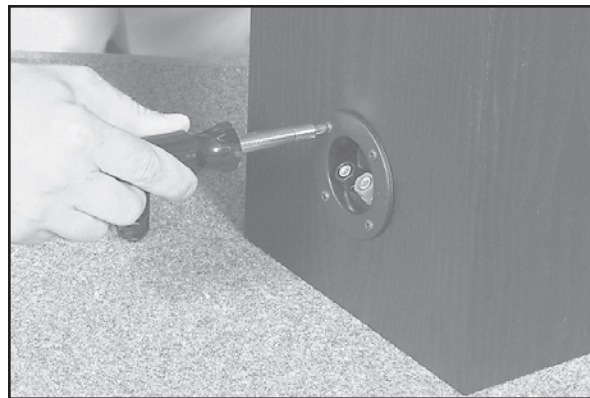
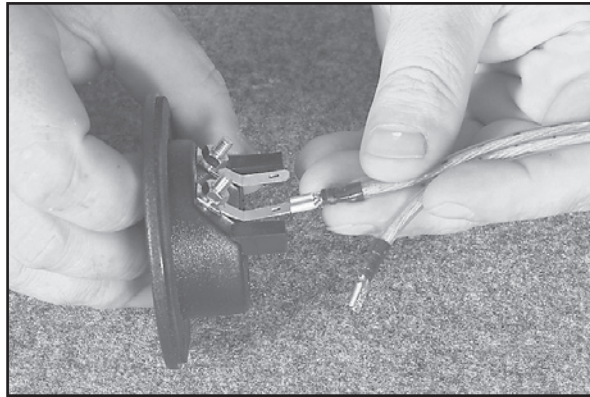

5. Repeat these steps for the other speaker cabinet.

B. Install Acoustic Damping Foam

We've included two (2) sheets of acoustic foam, one sheet for each speaker.

Acoustic damping foam absorbs internal standing waves inside the cabinet and prevents reflections to the woofer cone. You can install the foam using hot glue, RTV sealant or spray adhesive (3M Super77) if available.

A simply way to cut the foam is to leave the two sheets “nested” together while cutting. Place the foam on a flat surface and cut the foam with a straight edge and a utility knife. Make medium depth cuts with several strokes. Do not try to cut through the entire depth of foam with one cut.



1. The foam must be cut to fit internally on the right/left side walls, rear, top and bottom panels. Do not apply it to the front baffle. Cut the foam to the dimensions shown in Fig. 1.

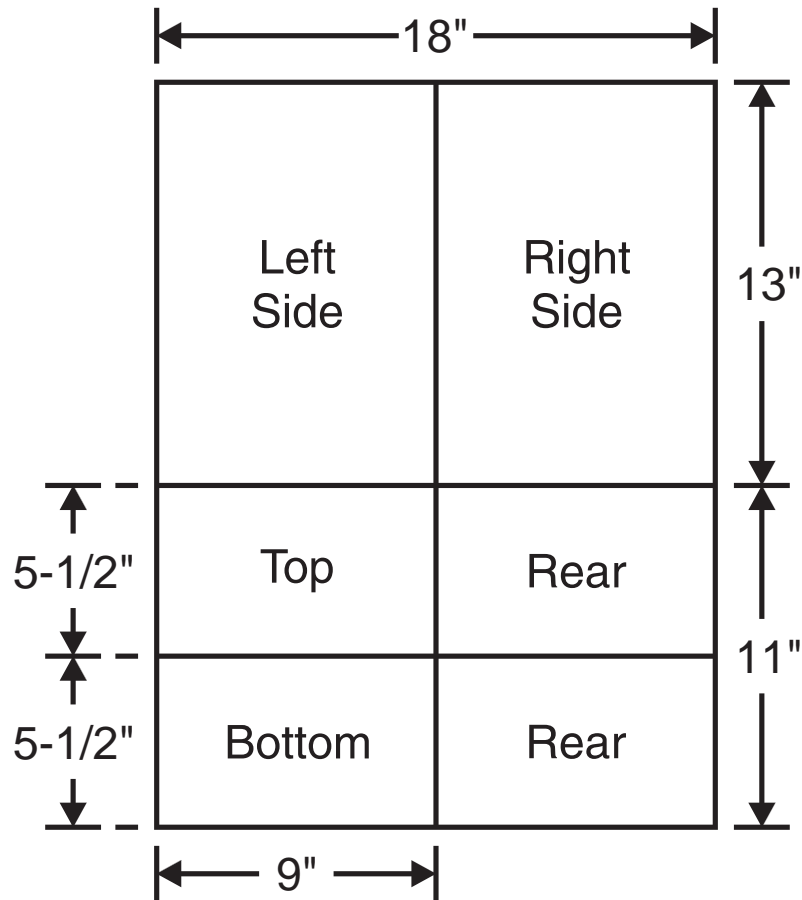
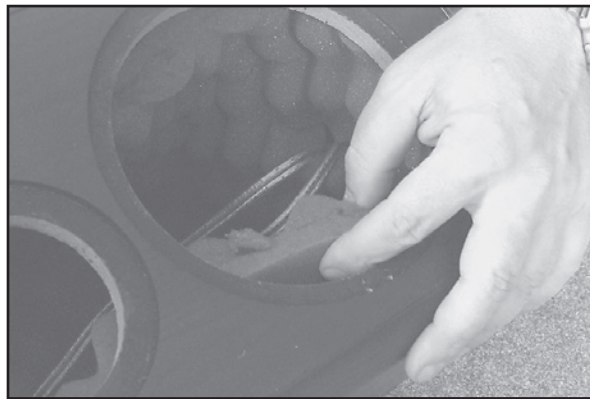

FIGURE 1: Foam Cutting

2. Install the foam on the back of the cabinet first and trim around the port tube. **Make sure it does not obstruct the airflow to the port tube, as this will alter the tuning of the box.**
3. Next install both sides and then top and bottom. The bottom piece of foam will simply lay on top of the crossover.



4. Position the "labeled" woofer and tweeter lead wires through the foam and run to their respective driver openings.

C. Installing Drivers

Put sealing caulk around the woofers prior to mounting. When applying caulk it is a good idea to first roll the caulk between your fingers to "thin out" the caulk bead. The tweeter is supplied with a gasket so it does not need sealing caulk. Putting sealing caulk on the tweeters mounting flange may not allow the faceplate to mount flush with the baffle.

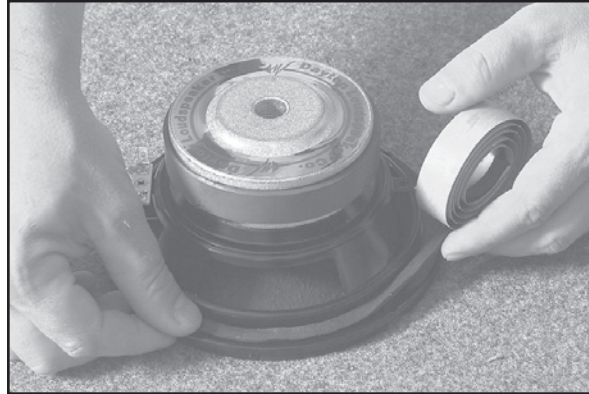

1. Attach each wire to the appropriate driver terminals while observing proper polarity (positive to positive, negative to negative). The tweeter has a red paint dot on the positive terminal. **If you decide to solder, be careful not to apply too much heat to the driver terminals especially the tweeters.**

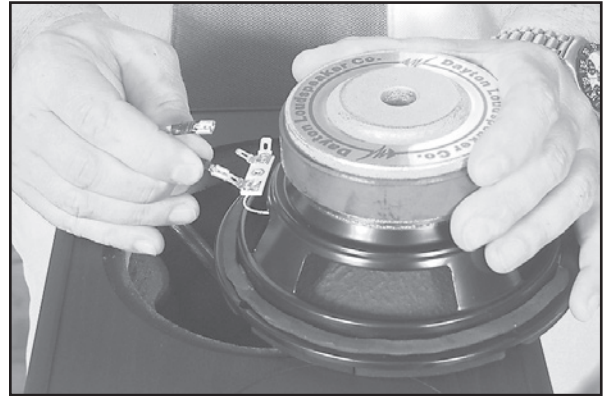

2. Install the drivers using the #8 (large) screws for the woofers and the #6 (small) screws for the tweeters. Be careful not to over tighten the screws and strip the wood.

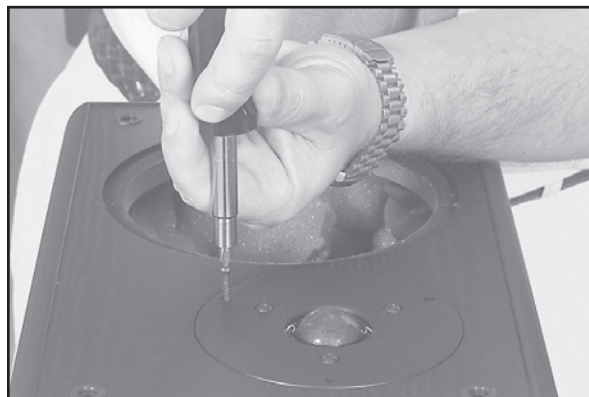



Speaker Placement

Many loudspeakers are designed without regard to baffle step loss. If a woofer has a midband sensitivity of 88 dB for example, and is mounted on a large infinite baffle (like your living room wall), it will maintain the 88 dB sensitivity right down to its rated F3. All frequencies, even the large low frequency wavelengths are supported by the large wall.

But speakers are usually mounted in boxes with varying degrees of baffle width. At a given frequency determined by the baffle dimensions, the lower frequency wavelengths start to 'wrap' behind the baffle. This is called a 2 pi to 4 pi transition and will result in a 6 dB loss in an anechoic chamber.

A typical two way speaker in a normal listening room will exhibit a 3 to 4 dB loss in the bass region. If left unchecked, most speakers will sound too thin with too much midrange output.

The BR-1 was designed with 4 dB of baffle step compensation which results in surprising bass output for a 6-1/2" diameter woofer. The midband is rolled off to match the woofer's natural in-room response to achieve the excellent bass performance. The trade off is a loss of some midband sensitivity, with an overall sensitivity of about 83 dB.

In most rooms, you will find the BR-1 to sound best placed approximately 3 feet from the rear wall and mounted on appropriate speaker stands. Ideally you want to place the speakers so they are at least 3-4 ft from side walls if possible.

Warranty Information

Dayton Audio products are constructed by industry experts, and are thoroughly tested before shipment. Dayton Audio products are warranted for the period of one year. This warranty is limited to manufacturer defects, either in materials or workmanship. Dayton Audio is not responsible for any consequential or inconsequential damage to any other unit or component or the cost for installation or extraction of any component of the audio system. In the rare case of a product failure, please contact your place of purchase or call our Customer Support Department at (937) 743-8248.

Warranty Limitations

There are no other warranties, either express or implied, which extend the foregoing, and there are no warranties of merchantability or fitness for any particular purpose. The warranty will not cover incidental or consequential damage due to defective or improper use of products. This includes but is not limited to burnt voice coils, overheating, bent frames, holes in the cone, or broken lead wires.

This warranty gives you specific legal rights and you may also have other rights which vary from state to state.

Non-Warranty Service: If non-warranty service is required, the product may be sent to the Company for repair/replacement, transportation prepaid, by calling (937) 743-8248 for details, complete instructions, and service fee charges.



daytonaudio.com
tel + 937.743.8248
info@daytonaudio.com

705 Pleasant Valley Dr.
Springboro, OH 45066
USA

