

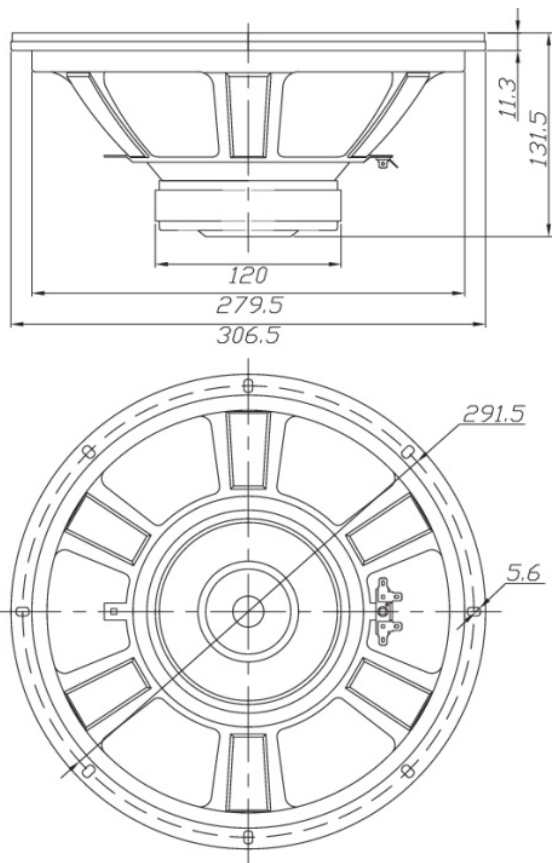

DC300-8 12" Classic Woofer 8 Ohm

DC300-8



PARAMETERS

Impedance	8 ohms
Re	6.8 ohms
Le	2.93 mH @ 1 kHz
Fs	22.9 Hz
Qms	3.21
Qes	0.37
Qts	0.33
Mms	100.7g
Cms	0.48 mm/N
Sd	498.8 cm ²
Vd	214.5 cm ³
BL	16.3 Tm
Vas	181.5 liters
Xmax	4.3 mm
VC Diameter	51 mm
SPL	90.3 dB @ 2.83V/1m
RMS Power Handling	80 watts
Usable Frequency Range (Hz)	25 - 2,500 Hz

FEATURES

- Works great as a general replacement woofer
- Excellent price/performance ratio
- Bring those old vintage speakers back to life
- Long lasting rubber surround beats foam

IMPEDANCE/PHASE



FREQUENCY RESPONSE

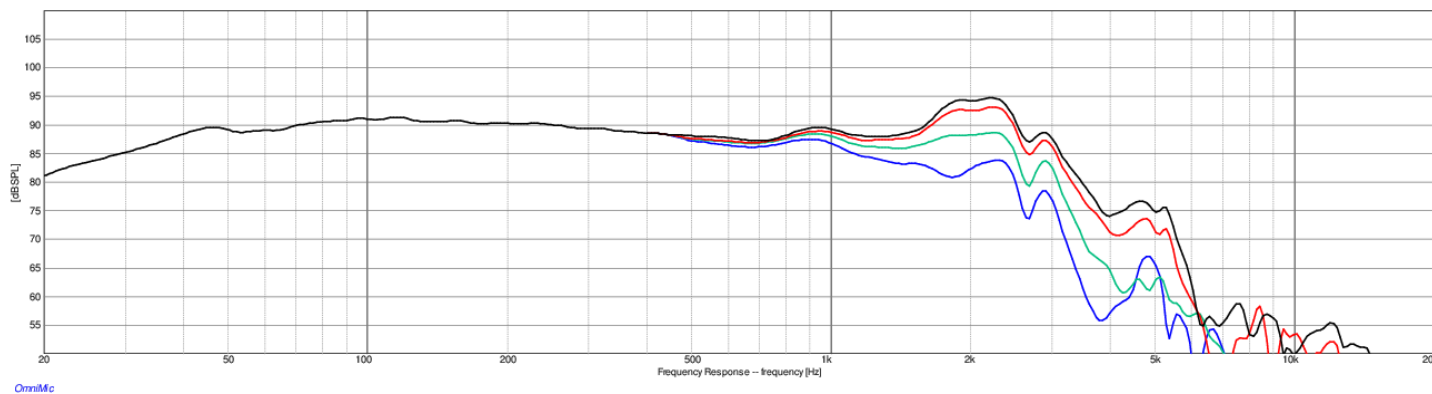

Note: 1/12th octave smoothing - nearfield response included in graph below 450 Hz.

Black = 0°
Red = 15°
Green = 30°
Blue = 45°