

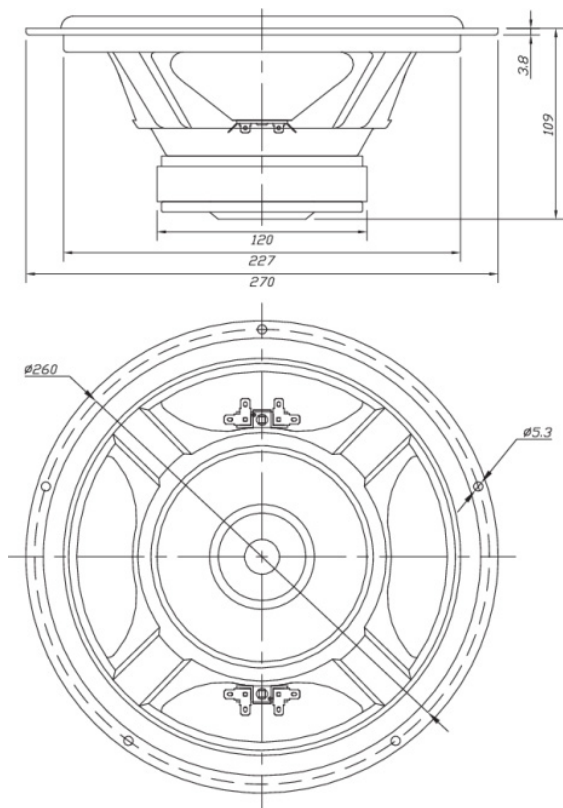

# SD270A-88 10" DVC Subwoofer 4 Ohm

SD270A-88



## PARAMETERS

Impedance	4 ohms
Re	3.16 ohms
Le	1.12 mH
Fs	26.2 Hz
Qms	3.23
Qes	0.50
Qts	0.43
Mms	57.70 g
Cms	0.64 mm/N
Sd	346.4 cm <sup>2</sup>
Vd	207.8 cm <sup>3</sup>
BL	7.80 Tm
Vas	107.5 liters
Xmax	6.0 mm
VC Diameter	38.5 mm
SPL	87.8 dB @ 1W/1m
RMS Power Handling	80 watts
Usable Frequency Range (Hz)	26 - 2,000 Hz

## FEATURES

- Works equally well in sealed or vented enclosures
- Attractive gasket-less design
- Long-life rubber surround for years of reliable service
- Excellent bottom octave performance

## IMPEDANCE/PHASE

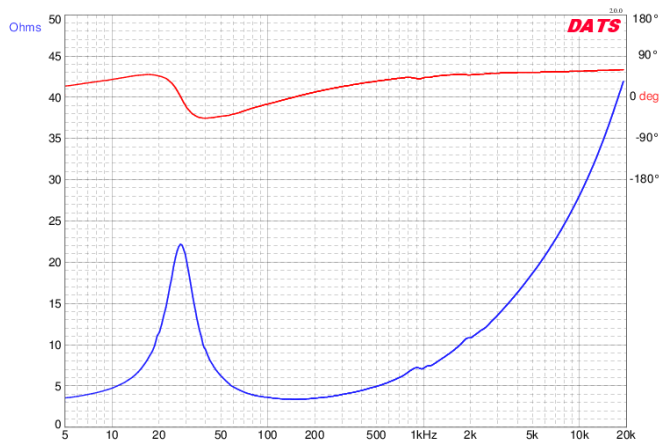

## FREQUENCY RESPONSE

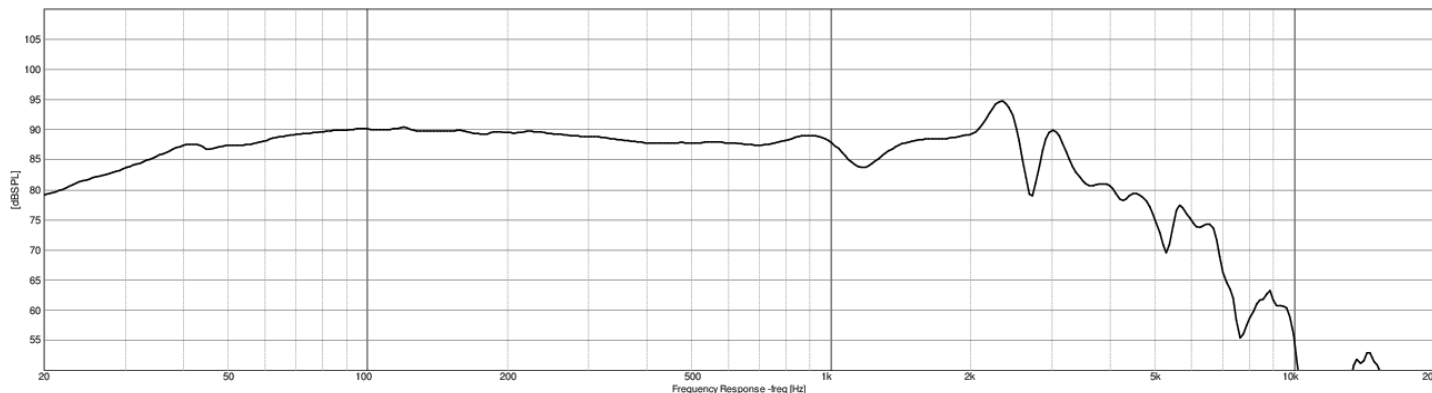

Note: 1/24<sup>th</sup> octave smoothing - nearfield response included in graph below 450 Hz.

Black = 0°