

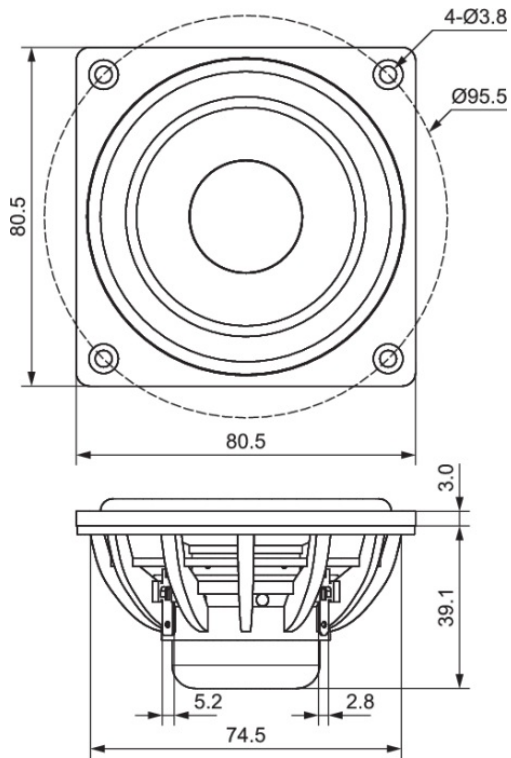

DMA80-4 3" Dual Magnet Aluminum Cone Full-Range Driver 4 Ohm



PARAMETERS

Impedance	4 ohms
Re	4.0 ohms
Le	0.2 mH @ 1 kHz
Fs	93.5 Hz
Qms	1.97
Qes	0.51
Qts	0.41
Mms	3.02 g
Cms	0.96 mm/N
Sd	31.2 cm ²
Vd	7.8 cm ³
BL	3.7 Tm
Vas	0.05 ft ³
Xmax	2.5 mm
VC Diameter	1"
SPL	88.9 dB @ 2.83V/1m
RMS Power Handling	25 watts
Usable Frequency Range (Hz)	90-20,000 Hz

FEATURES

- Excellent high frequency response for true full-range applications
- Dual neodymium motor to create a symmetrical magnetic field for superb control
- Large copper cap lowers distortion while improving high frequency response
- Vented aluminum voice coil former with exceptional heat dissipation for high power handling
- Exclusive 12-spoke open frame design provides extensive venting and minimal reflection
- DIY friendly, oversized mounting flange makes installation simple
- Matching tunable passive radiators also available!

IMPEDANCE/PHASE

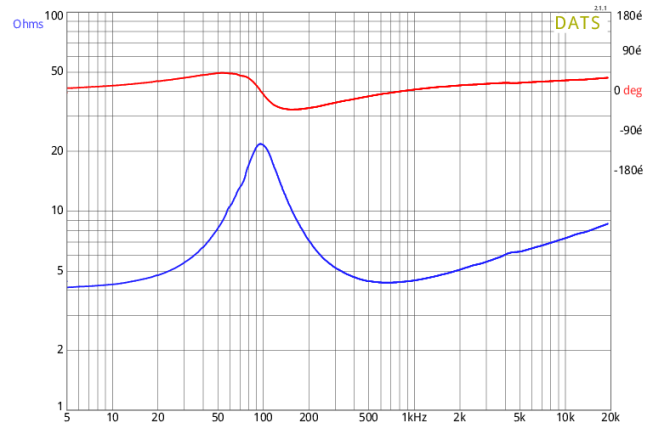

FREQUENCY RESPONSE

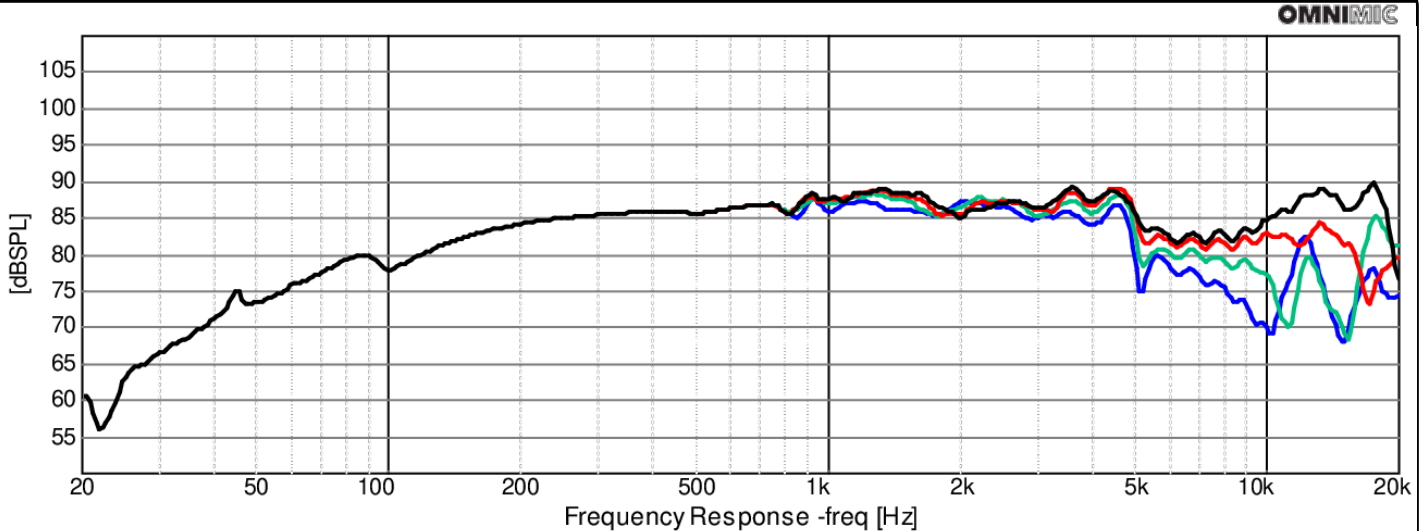

OmniMic

Note: 1/24th octave smoothing - nearfield response included in graph below 450 Hz.

Black = 0°
Red = 15°
Green = 30°
Blue = 45°