

Model No: SLS-P830669
 Product Line: Peerless

Rev: 1.0
 Last Update: 2015-11-23 02:10:29

Product Description

The SLS line combines high quality performance with an affordable design. This 12 inch 8 ohm member of the SLS family features a rigid steel basket, a coated paper cone, and a ferrite magnet motor with aluminium shorting ring for improved distortion performance.



Mechanical Drawing

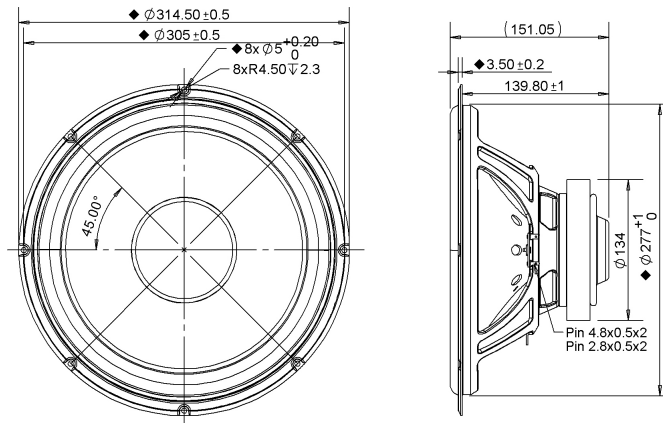

Specifications

DC Resistance	Revc	Ohms	5.6	5.0%	Energy Bandwidth Product	EBP	(1/Qes)*fs
Minimum Impedance	Zmin	Ohms	6.95	7.5%	Moving Mass	Mms	g
Voice Coil Inductance	Le	mH	1.12		Suspension Compliance	Cms	um/N
Resonant Frequency	Fs	Hz	31.48	15%	Effective Cone diameter	D	cm
Mechanical Q Factor	Qms		7.07		Effective Piston Area	Sd	cm^2
Electrical Q Factor	Qes	0.58			Effective Volume	Vas	L
Total Q Factor	Qts	0.54			Motor Force Factor	BL	Tm
Ratio Fs/Qts	F	Fs/Qts	58.51		Motor Efficiency Factor	β	(T*M^2)/Ohms
Half Space Sensitivity @2.83V	db@2.83V/1M	dB	89.85	+/- 1.0db	Voice coil former Material	VCfm	GSV
Half Space Sensitivity @1W/1M	db@1W/1M	dB	89.2	+/- 1.0db	Voice coil inner diameter	VCd	mm
Gap Height	Gh	mm	8		Rated Noise Power	P	W
Maximum Linear Excursion	Xmax	mm	8.3		Test Spectrum Bandwidth		30Hz - 2kHz
Ferrofluid Type	FF				Transducer Size	Inch	12 in
Transducer Mass	Kg	3.24					

Frequency and Impedance Response

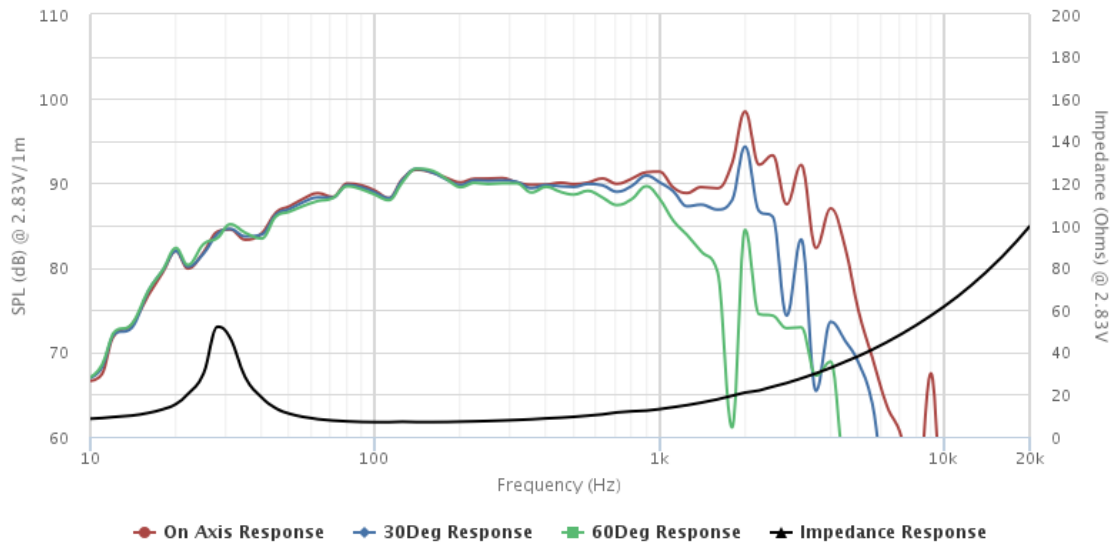

Highcharts.com