

Model No.: FSL-1225R02-08

Rev: 1

Product Line: Tymphany

Last Update: 2017-04-25 14:32:09

Product Description

This 12 inch 8 ohm speaker, features a FEA optimized ferrite magnet motor, a 2.5 inch high-temperature voice coil, a vented yoke for motor cooling, and a high strength stamped steel frame. It also features Kevlar loaded non-pressed paper cone to help dampen and control cone resonance. The multi-roll surround and spider have been optimized to reduce distortion over the excursion range of this transducer.



Mechanical Drawing

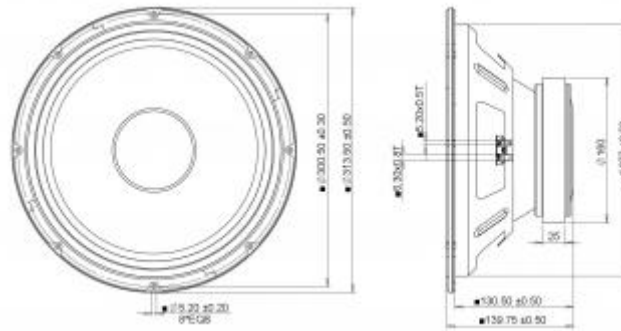

Specifications

DC Resistance	Revc	Ohms	5.45	5.0%	Energy Bandwidth Product	EBP	(1/Qes)*fs
Minimum Impedance	Zmin	Ohms	7.39	7.5%	Moving Mass	Mms	g
Voice Coil Inductance	Le	mH	0.71		Suspension Compliance	Cms	um/N
Resonant Frequency	Fs	Hz	59.07	15%	Effective Cone diameter	D	cm
Mechanical Q Factor	Qms		4.31		Effective Piston Area	Sd	cm ²
Electrical Q Factor	Qes		0.45		Effective Volume	Vas	L
Total Q Factor	Qts		0.41		Motor Force Factor	BL	Tm
Ratio Fs/Qts	F	Fs/Qts	145.5		Motor Efficiency Factor	β	(T*M ²)/Ohms
Half Space Sensitivity @2.83V	db@2.83V/1M	dB	96.85	+/- 1.0db	Voice coil former Material	VCfm	GSV
Half Space Sensitivity @1W/1M	db@1W/1M	dB	96.5	+/- 1.0db	Voice coil inner diameter	VCd	mm
Gap Height	Gh	mm	8		Rated Noise Power	P	W
Maximum Linear Excursion	Xmax	mm	2.5		Test Spectrum Bandwidth		60Hz-600Hz
Ferrofluid Type	FF				Driver Size	Inch	12 in
Driver Mass	Kg		4.9				

Frequency and Impedance Response



Highcharts.com