

Model No.: PMT-40N25AL01-04

Rev: 1

Product Line: Tymphany

Last Update: 2017-04-25 14:32:09

Product Description

This 40 mm 4 ohm compact premium micro transducer is designed for computer, television array, and similar applications. It features a neodymium magnet, a light aluminium cone, and a high-temperature polycarbonate frame. The PMT family's transducers feature low resonant frequencies, low THD and a full range bandwidth.



Mechanical Drawing

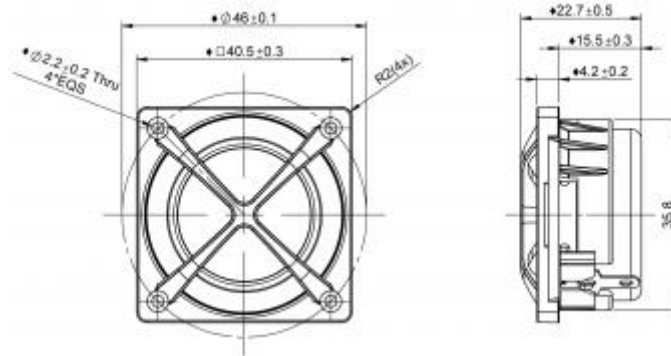

Specifications

DC Resistance	Revc	Ohms	3.67	5.0%	Energy Bandwidth Product	EBP	(1/Qes)*fs
Minimum Impedance	Zmin	Ohms	4.39	7.5%	Moving Mass	Mms	g
Voice Coil Inductance	Le	mH	0.08		Suspension Compliance	Cms	um/N
Resonant Frequency	Fs	Hz	234.6	15%	Effective Cone diameter	D	cm
Mechanical Q Factor	Qms		2.21		Effective Piston Area	Sd	cm ²
Electrical Q Factor	Qes		0.61		Effective Volume	Vas	L
Total Q Factor	Qts		0.48		Motor Force Factor	BL	Tm
Ratio Fs/Qts	F	Fs/Qts	492.86		Motor Efficiency Factor	β	(T*M ²)/Ohms
Half Space Sensitivity @2.83V	db@2.83V/1M	dB	85.44	+/- 1.0db	Voice coil former Material	VCfm	KSV
Half Space Sensitivity @1W/1M	db@1W/1M	dB	82.8	+/- 1.0db	Voice coil inner diameter	VCd	mm
Gap Height	Gh	mm	2		Rated Noise Power	P	W
Maximum Linear Excursion	Xmax	mm	1.9		Test Spectrum Bandwidth		100 Hz - 20K Hz
Ferrofluid Type	FF		APG834		Driver Size	Inch	40 mm
Driver Mass	Kg		0.07				

Frequency and Impedance Response

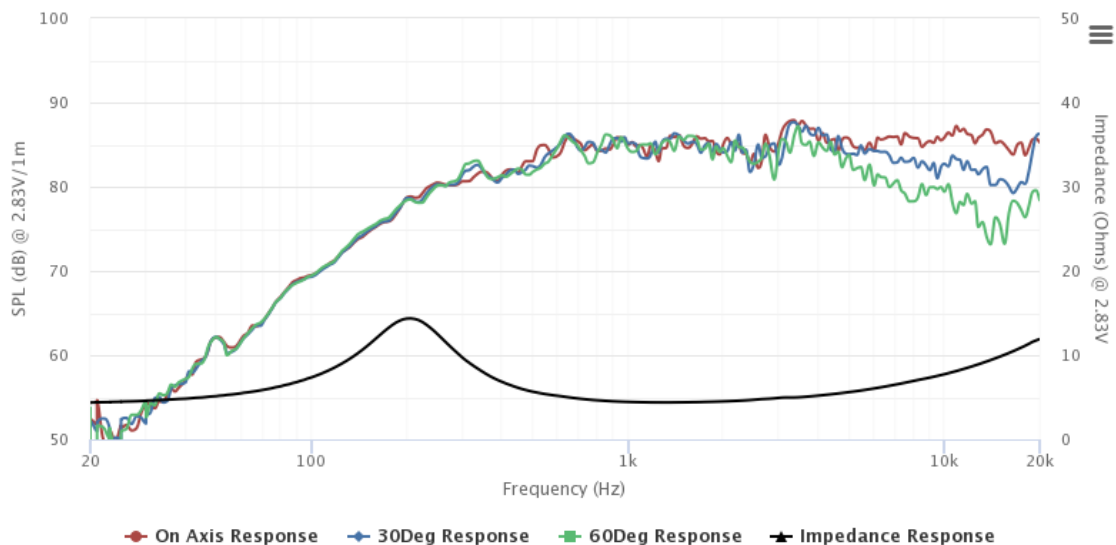

Highcharts.com