



# INSTALLATION AND OPERATION MANUAL

# DIGIPAGE

MULTIZONE PAGING AND SOURCE SELECTION SYSTEM

## IMPORTANT SAFETY INFORMATION

1. Read these instructions.
2. Keep these instructions.
3. Heed all warnings.
4. Follow all instructions.
5. Do not use this apparatus near water.
6. Clean only with dry cloth.
7. Do not block any ventilation openings. Install in accordance with the manufacturer's instructions.
8. Do not install near any heat sources such as radiators, heat registers, stoves, or other apparatus (including amplifiers) that produce heat.
9. Do not defeat the safety purpose of the polarized or grounding-type plug. A polarized plug has two blades with one wider than the other. A grounding type plug has two blades and a third grounding prong. The wide blade or the third prong are provided for your safety. If the provided plug does not fit into your outlet, consult an electrician for replacement of the obsolete outlet.
10. Protect the power cord from being walked on or pinched particularly at plugs, convenience receptacles, and the point where they exit from the apparatus.
11. Only use attachments/accessories specified by the manufacturer.
12. Use only with the cart, stand, tripod, bracket, or table specified by the manufacturer, or sold with the apparatus. When a cart is used, use caution when moving the cart/apparatus combination to avoid injury from tip-over.
13. Unplug this apparatus during lightning storms or when unused for long periods of time.
14. Refer all servicing to qualified service personnel. Servicing is required when the apparatus has been damaged in any way, such as power-supply cord or plug is damaged, liquid has been spilled or objects have fallen into the apparatus, the apparatus has been exposed to rain or moisture, does not operate normally, or has been dropped.
15. This appliance shall not be exposed to dripping or splashing water and that no object filled with liquid such as vases shall be placed on the apparatus.
16. Plug this apparatus to the proper wall outlet and make the plug to be disconnected readily operable.
17. Mains plug is used as disconnected device and it should remain readily operable during intended use. In order to disconnect the apparatus from the mains completely, the mains plug should be disconnected from the mains socket outlet completely.
18. **WARNING:** To reduce the risk of fire or electric shock, do not expose this apparatus to rain or moisture.
19. An appliance with a protective earth terminal should be connected to a mains outlet with a protective earth connection.
20. The apparatus should be disconnected from the mains completely before speaker wiring. The speaker output should be proper protected from direct contact and pay attention to speaker connections, terminals and speaker wiring during normal operation.



## PRÉCAUTIONS DURANT UTILISATION

1. LISEZ ces instructions.
2. Tenez ces instructions.
3. Notez tous les avertissements.
4. Suivez toutes les avertissements.
5. N'utilisez pas ce produit près de l'eau (la piscine, la plage, le lac, etc.).
6. Nettoyez seulement avec une étoffe sèche.
7. Ne bloquez aucuns trous de ventilation. Installez en accord avec les instructions du fabricant.
8. N'installez près aucunes sources de chaleur comme radiateurs, registres de chaleur, fours ou les autres équipements (y compris amplificateurs) qui produisent la chaleur.
9. Ne défaites pas le but de sécurité de la fiche polarisée ou base-type. Une fiche polarisée a deux tranchants avec un plus large que l'autre. Une fiche de base type a deux tranchants et une troisième pointe de base, le tranchant large ou la troisième pointe est fourni pour votre sécurité. Si la fiche donnée ne conforme pas votre prise de contact, consultez un électricien pour remplacement de la prise de contact obsolète.
10. Protégez le cordon de secteur contre être marchée dessus ou pincez en particulier aux fiches, aux douilles de convenance, et au point où ils sortent de l'appareil.
11. Seulement utilisez attachements/accessoires spécifiés par le fabricant.
12. Utilisez seulement avec un chariot, un stand, un trépied, un support ou une table indiquée par le fabricant, ou vendue avec l'appareil. Quand un chariot est utilisé, faites attention en déplaçant la combinaison d'appareil/chariot pour éviter de se déséquilibrer.
13. Arrachez la fiche du dispositif durant éclair et orage ou quand pas utilisé pour longues périodes de temps.
14. Référez au personnel qualifié de service pour toutes réparations. La réparation est donnée quand le système a été endommagé à n'importe façon, par exemple un fil ou une fiche endommagé(e) de la source d'alimentation. Avoir été exposé à pluie ou humidité, n'opère pas normalement, ou avoir été tombé.
15. L'appareil ne doit pas être exposé aux écoulements ou aux éclaboussures et aucun objet ne contenant de liquide, tel qu'un vase, ne doit être placé sur l'objet.
16. Branchez l'appareil à une source appropriée et faire que la prise à débrancher soit facilement accessible.
17. La prise du secteur ne doit pas être obstruée ou doit être facilement accessible pendant son utilisation. Pour être complètement déconnecté de l'alimentation d'entrée, la prise doit être débranchée du secteur.
18. **AVERTISSEMENT:** Pour éviter le risque d'incendie ou de chocs électriques, ne pas exposer cet appareil à la pluie ou à l'humidité.
19. Un appareil avec la borne de terre de protection doit être connecté au secteur avec la connexion de terre de protection.
20. Assurez-vous que l'appareil est hors tension avant de connecter les hauts parleurs. Vérifiez que la sortie des enceintes soit protégées contre un contact physique. Respecter les polarités des terminaux ainsi que le câblage des enceintes pendant le fonctionnement afin d'assurer une utilisation sécurisée.





## DIJIPAGE

The Australian Monitor Installation Series DigiPage is a 3 rack unit multizone paging and source selection system that offers unprecedented flexibility for multizone paging & source routing applications.

Six program inputs and one dedicated local mic/line input are available to each of eight zone outputs. With LED indication for program/local input selection, zone output level, paging enable/disable and network busy LED, the DigiPage provides extensive status indication to the user.

The DigiPage is also expandable to 16 zones via a simple link cable to a second unit. Paging stations are available in 8 zone and 16 Zone models allowing paging into any individual zone, any combination of zones or All Call. Remote control panels are also available allowing source selection and volume control from within each remote zone.

Both the Paging stations and remote control panels connect via an inexpensive and industry standard CAT5 cable network. An overall priority input is also provided for emergency or evacuation signals.

The DigiPage is powered by an (included) external plug-pack power supply or via 24VDC. The DigiPage is an incredibly versatile and well featured product that provides a simple solution to the complex applications of multizone paging and source routing.

We thank you for choosing Australian Monitor Installation Series and as with all our products, the DigiPage offers clever features and is contractor friendly.

INTRODUCTION	3
FRONT PANEL	4
REAR PANEL	6
INSTALLATION	8
DIMENSIONS	11
SETUP	12
TROUBLESHOOTING	13
LINKING TWO DIGIPAGE SYSTEMS	14
OPERATION	15
PAGING STATION	16
REMOTE CONTROL PANEL	18
BLOCK DIAGRAM	20
ACCESSORIES	21
SPECIFICATIONS	22

AUS, EUR, USA  
Rev D: 16 Oct 2014

## WARNING!

TO PREVENT FIRE OR SHOCK HAZARD, DO NOT USE THE PLUG WITH AN EXTENSION CORD, RECEPTACLE OR OTHER OUTLET UNLESS THE BLADES CAN BE FULLY INSERTED TO PREVENT BLADE EXPOSURE.  
TO REDUCE THE RISK OF FIRE OR ELECTRIC SHOCK, DO NOT EXPOSE THIS APPLIANCE TO RAIN OR MOISTURE.  
TO PREVENT ELECTRICAL SHOCK, MATCH WIDE BLADE PLUG TO WIDE SLOT & FULLY INSERT.

## CAUTION

THESE SERVICING INSTRUCTIONS ARE FOR USE BY QUALIFIED SERVICE PERSONNEL ONLY.  
TO REDUCE THE RISK OF ELECTRIC SHOCK DO NOT PERFORM ANY SERVICING OTHER THAN THAT CONTAINED IN THE OPERATING INSTRUCTIONS UNLESS YOU ARE QUALIFIED TO DO SO.



The lightning flash with arrowhead symbol, within an equilateral triangle, is intended to alert the user to the presence of uninsulated "dangerous voltage" within the product's enclosure that may be of sufficient magnitude to constitute a risk of electric shock to persons.

### CAUTION

**RISK OF ELECTRIC SHOCK  
DO NOT OPEN**

**WARNING:**  
TO REDUCE THE RISK OF ELECTRIC SHOCK, DO NOT REMOVE COVER (OR BACK). NO USER SERVICEABLE PARTS INSIDE. REFER SERVICING TO QUALIFIED SERVICE PERSONNEL.



The exclamation point within an equilateral triangle is intended to alert the user to the presence of important operating and maintenance (servicing) instructions in the literature accompanying the appliance.



For European Union countries: This symbol on the product or its packaging indicates that this product must not be disposed of with other waste. Instead, it is your responsibility to dispose of your waste equipment by handing it over to a designated collection point for the recycling of waste electrical and electronic equipment. Please contact your local authority for further details of your nearest designated collection point.

Rating plate and caution marking are marked on the back enclosure of the apparatus



# FRONT PANEL

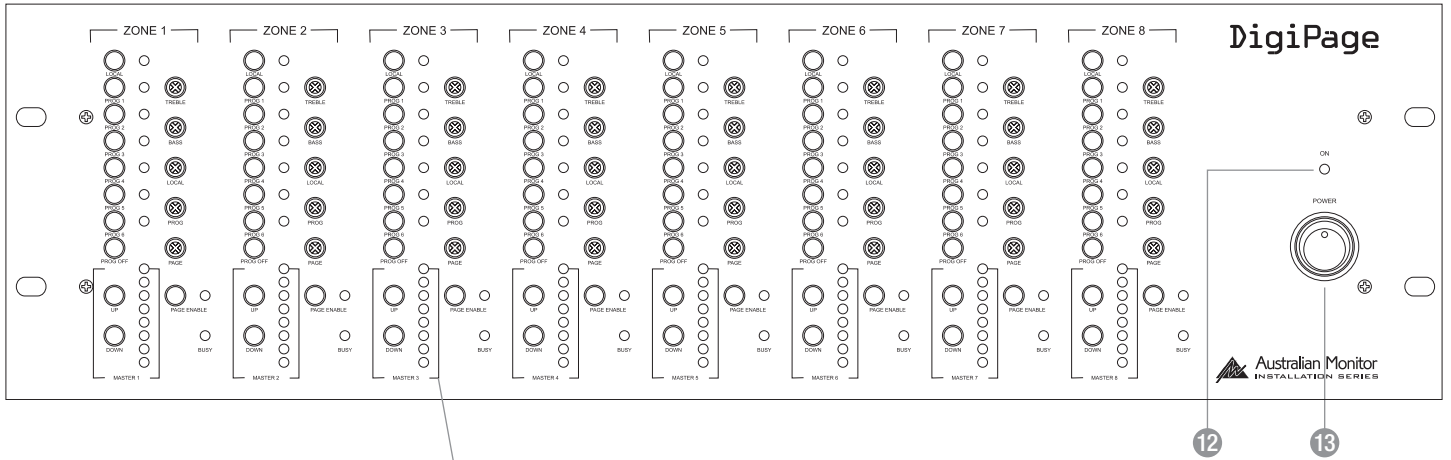

## Expanded view

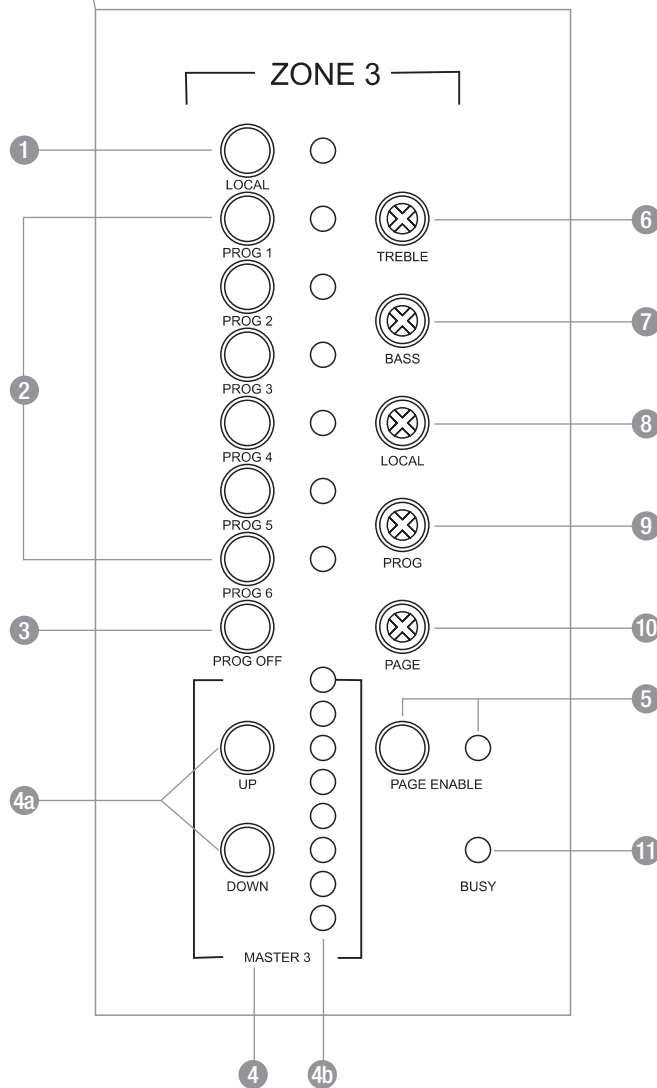



The controls detailed below (1-12) apply to each output zone, as indicated by ZONE 1 to ZONE 8 on the front panel.

### 1 Local

This switch will turn the local input on or off in the zone. The local input is for exclusive use in the zone (eg Local Input 3 to Zone 3). The Local switch operates independently of the program switches. The local input can be mic or line; see Rearpanel on page 6.

### 2 Prog 1-6

This series of program switches (PROG 1– PROG 6) allows the connected program sources to be switched to the desired zone. Program inputs may be mic or line, see Rearpanel on page 6. The program sources can be selected individually, or multiple program sources can be mixed together. Operation is as follows:

- Select one program source
- Press momentarily
- Add another program source
- Press and hold for 2 secs
- Deselect program source
- Press and hold for 2 secs
- Turn off all program sources
- Press Prog Off

### 3 Prog Off

This switches program off in the desired zone.

### 4 Master 1-8

#### 4a Up/Down

These buttons increase and decrease the zone output level.

#### 4b

Master volume control position indication.

 **NOTE:** This is NOT a signal level meter. It indicates relative volume position.

### 5 Page Enable

This switch allows the zone to be included in or isolated from the paging stations. You may want to do this when a zone is for an area such as a function room that occasionally may need to be isolated from paging. When this button is pressed, the adjacent green indicator lights, indicating that the zone is able to receive paging.

### 6 Treble

The treble control has 9dB of cut or boost at 10kHz. The treble control affects the entire zone.

 **NOTE:** This 'center' is to the left (9 o'clock), not the top (12 o'clock).

### 7 Bass

The bass control has 12dB of cut or boost at 100Hz. The bass control affects the entire zone.

 **NOTE:** This 'center' is to the left (9 o'clock), not the top (12 o'clock).

### 8 Local

This control adjusts the level of the local input into the zone.

### 9 Prog

This control adjusts the overall level of all program sources into the zone.

 **NOTE:** To balance the differing levels of each program input, the program trim controls on the rear panel should be used (see Rear Panel and Setup sections)

### 10 Page

This control adjusts the paging mic level into the zone.

### 11 Busy

This LED indicates that the control network is busy in this zone. The zone is currently being paged or adjusted.

Located at the right-hand end of the unit, these controls affect all zones.

### 12 On Indicator

This LED indicates there is power to the unit.

 **NOTE:** When 24VDC emergency power is supplied this LED will always be on.

### 13 Power Switch

This switches power from the power supply (included).

 **NOTE:** When 24VDC emergency power is supplied, the unit is on regardless of the switch position



# REAR PANEL

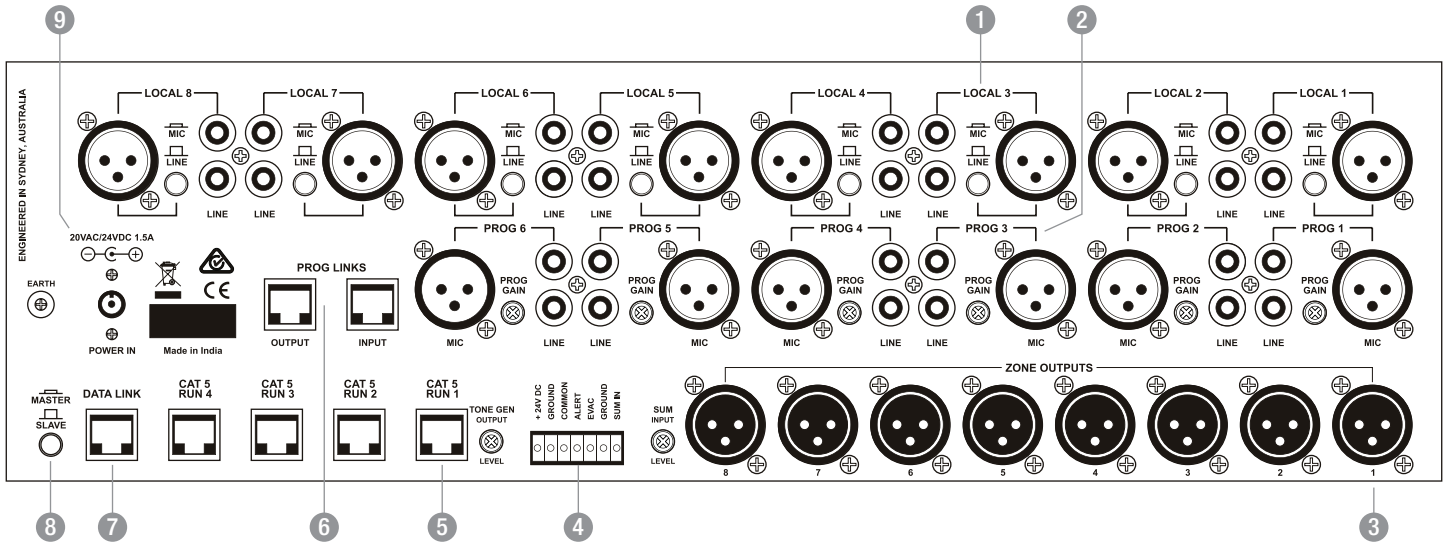



## 1 Local 1-8 Input Section

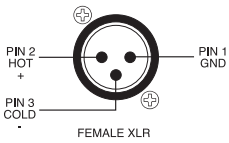
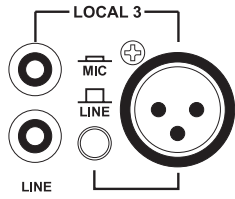

**LINE** The pair of RCA sockets accepts unbalanced line level inputs. Stereo signals are internally summed to mono.

**MIC/LINE** The switch selects the sensitivity of the balanced XLR input **ONLY**. Switch in: microphone level Switch out: line level The XLR socket accepts balanced microphone or line level signals.

**NOTE:** The Local Input is routed only to the same numbered zone output and is switched on or off via the front panel or remote control panel.

## 2 Prog 1-6 Input Section

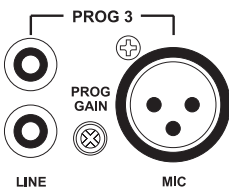

**LINE** The pair of RCA sockets accepts unbalanced line level inputs. Stereo signals are internally summed to mono.

**MIC** The XLR socket accepts balanced microphone level signals.

**PROG GAIN** The trimpot controls the input gain of **BOTH** the balanced and unbalanced program inputs.

In a Master/Slave configuration, these also control program linked inputs. (see Linking Section)

## 3 Zone Outputs

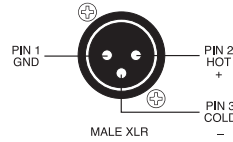

There is a balanced XLR line level output for each zone.

**NOTE:** If connecting to an unbalanced input, the negative pin (3) should not be connected to ground but left floating.

**NOTE:** When operating as a slave unit, outputs labelled 1 to 8 will correspond to zones 9 to 16, respectively. (see Linking Section)

## 4 Euroblock Connector

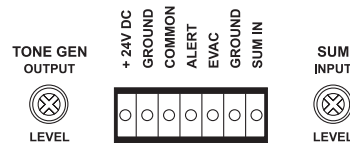

**24V DC / GROUND** This input pair is for connection to a 24VDC emergency power supply and is not switched by the front panel power switch.

**NOTE:** The 24V DC input does not provide a trickle-charge facility.

**ALERT/EVAC/COMMON** These connections are used to trigger the internal tones. Only one tone can be triggered at a time. Triggering occurs by connecting the ALERT or EVAC terminal to COMMON.

**GROUND/SUM IN** This is an unbalanced line level input which may be used for emergency priority signals. It feeds all outputs independent of output level settings and page enable status.

**NOTE:** Signal on the SUM IN will cause other signals to be muted.

**SUM INPUT LEVEL** This recessed trimpot sets the level of the sum input.

**TONE GEN OUTPUT LEVEL** This recessed trim pot controls the output level of the tones and the chime.

## 5 Cat 5 Run 1-4

These RJ45 inputs accept the CAT5 cables coming from the paging microphone stations and the remote control panels. See page 10 for more information.

**NOTE:** These are NOT Ethernet connections.

**NOTE:** Connecting and disconnecting these inputs while the unit is on may cause the unit to lock up requiring system power to be cycled.

## 6 Prog Links

These RJ45 sockets allow linking of the program sources when using a Master/Slave configuration. (see Linking Section)

**NOTE:** These are NOT Ethernet connections.

## 7 Data Link

This socket is used to link two units in a Master/Slave configuration. (see Linking Section)

**NOTE:** These are NOT Ethernet connections.

## 8 Master/Slave

This switch is used when linking 2 units in Master/Slave configuration. (see Linking Section)

## 9 Power In Vac

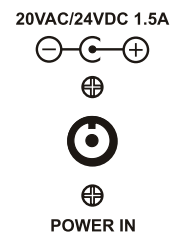

This 2.1mm x 5.5mm power socket accepts 20VAC or 24VDC. For DC, tip is positive.



# INSTALLATION

## OVERVIEW

The DigiPage features extensive flexibility in the range of input sources that it can accommodate. In addition, the zone outputs may be used to feed power (booster) amplifiers, mixers, mixer amplifiers etc. It is therefore important to think about the interfacing of the DigiPage with the other equipment if optimum performance is to be achieved. Use the Back Panel and Specifications sections of this manual to assist with system design.

### NOTE: XLR Configuration

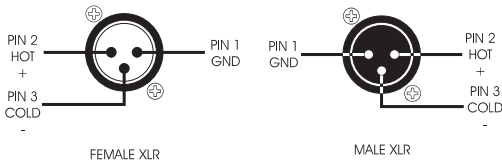

When wiring the outputs on the DigiPage as unbalanced, Pin2 should be used as hot and Pin1 as ground. Pin3 should be left open and NOT shorted to Pin1.

**NOTE:** If installing and terminating CAT5 cable is new to you, please take note of the various points that follow. As the CAT5 cabling for the DigiPage carries voltage, damage could occur if your pin-pin connections are not made correctly.

### Cable Installation for Paging Stations and Remote Panels

Four RJ45 ports (labelled CAT 5 RUN 1-4) are provided for connection to the DigiPage Zone Paging Stations and Remote wall panels. The four ports allow for easy cable infrastructure, as CAT5 runs can be of differing lengths depending on the installation and the number of units connected.

In planning the installation, the following rules apply:

- Up to 4 Paging Stations, remote control panels or combinations of the two may be connected to each of the four CAT5 runs.
- Connections along the runs must be in a daisy-chain configuration. It is acceptable to create a short branch (eg, from a wall to a paging station). The maximum length of the branch is 10m.
- The following table indicates the maximum distance allowable for a CAT5 run on a single port.
- For greater distances or more units, see page 10.
- The last unit on a run must be terminated. This is done by moving a jumper on the paging station or remote unit. See 'Paging Station' on pages 16-17 or 'Remote Control Panel' on pages 18-19.

**NOTE:** These are NOT Ethernet connections.

Combination Of Devices On Single Cat5 Run	Max Distance To End Unit (M/FT)
1 X Paging Station	250M/820Ft
2 X Paging Stations	125M/410Ft
3 X Paging Stations	80M/260Ft
4 X Paging Stations	62.5M/205Ft
1 X Wallplate	500M/1640Ft
2 X Wallplates	250M/820Ft
3 X Wallplates	165M/540Ft
4 X Wallplates	125M/410Ft
1 X Paging Station & 1 X Wallplate	165M/540Ft
1 X Paging Station & 2 X Wallplates	125M/410Ft
1 X Paging Station & 3 X Wallplates	100M/330Ft
2 X Paging Stations & 1 X Wallplates	100M/330Ft
2 X Paging Stations & 2 X Wallplates	80M/260Ft
3 X Paging Stations & 1 X Wallplate	70M/230Ft





## CAT5 Cable

CAT5 cable is the blue cable commonly used for data installations (other colours do exist). It consists of four twisted pairs of wires: this is why it is referred to as UTP (Unshielded Twisted Pair). The most readily available cable uses solid conductors, like telephone wire. Cable with stranded conductors is available, and is more flexible.

## CAT5 Termination

Pre-wired CAT5 cable comes in two configuration standards, 568A and 568B. It is advisable to carry a good pre-wired cable for fault-finding. Both configurations will work with the DigiPage provided both ends have the same configuration. Be careful not to use a crossover cable which has one configuration at one end and the other configuration at the other end.

Ensure that the RJ45 connectors are suited to the cable used (solid or stranded) and that the correct crimp tool is used.

When wiring connectors, 568A standard wiring is recommended (see diagram). Note that this is only the recommended wiring and that you should check the configuration of any cables that you are using.

## Digipage Network Cabling

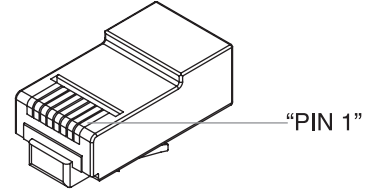

### 568A Configuration

Pin	Wire Colour	Dp Network
1	White/Green	Ground
2	Green	Power
3	White/Orange	Data+
4	Blue	Busy-
5	White/Blue	Busy+
6	Orange	Data-
7	White/Brown	Voice+
8	Brown	Voice-

**NOTE:** CAT5 cable consists of four pairs of wires: it is not sufficient to simply wire the two ends pin for pin, ignoring pairing.

## Power Requirements

The DigiPage can operate from the plug pack supplied and/or a separate 24V DC power supply.

**A NOTE ABOUT GROUNDING:** It may be necessary in some circumstances to ground the DigiPage to eliminate noise in the system. This can be done using the negative terminal of the 24VDC IN euro connector or by making sure that the chassis is electrically connected to the equipment rack (which should be grounded).



# INSTALLATION

## Extending CAT5 Cable Run Distances & Adding More Paging Stations & DPRMs

The maximum distances quoted in the Table #1 are due to DC current limitations, not data transmission limitations. If distances greater than these are required, the paging stations and DPRM's can be locally powered. This will extend the maximum distances to 1000m per CAT5 RUN. Alternatively, if more than 4 paging stations or DPRM's are required on a single run, local powering can be used. This will increase the maximum number of paging stations and DPRM's on a single CAT5 RUN.

Use a regulated 12VDC supply connected as

pin1 (white/green in CAT5)- GROUND

pin2 (green in CAT5) - +12V

Disconnect incoming +V, but not ground. The 12V supply should be rated at 150mA per paging station being powered and 90mA per DPRM. For further information email [techsupport@australianmonitor.com.au](mailto:techsupport@australianmonitor.com.au).

## Tone Generator Inputs

Tones may be triggered by closing a switch or relay contact between the selected tone trigger input and common. These trigger inputs are 5V TTL and may alternatively be triggered by pulling the desired input low referenced to the COMMON.

**NOTE:** The maximum voltage on these inputs must not exceed 5.5V

## Pre-Announce Chime

The only internal setup that is available in the DigiPage is for the configuration of the chime tone that sounds in each zone. The unit comes shipped with the chime enabled in all zones.

A link can be found on each zone control board at the front of the unit (the longer board behind the zone section).

To disable the chime to a particular zone, move the link to the upper two pins on the relevant control board. To re-enable the chime, move the link to the lower two pins.

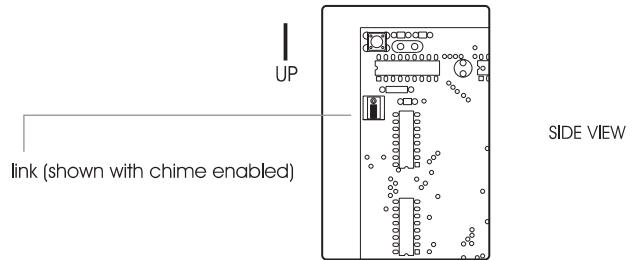





## SETUP

The inputs of the DigiPage can accommodate a wide range of sources including active paging stations, dynamic microphones, DVD and CD players. The zone outputs may be used to drive power (booster) amplifiers, mixers, or mixer amplifiers.

Each installation will require setting the appropriate relative mix of levels between paging, program sources and local inputs for each zone and balancing between the zones.

Because of the variation in levels between the possible sources, DigiPage offers a number of gain stage adjustment so you can set the correct levels for your application.

Also consider what the outputs are driving.

Setting up correct gain structure through the whole system is important to achieve optimal results.

The following step by step procedure has been devised to assist during the setup process.

When the DigiPage was shipped to you from the factory it was set up in a particular way. In the following procedure it is essential that you are starting from these initial settings.

- Program Input Gain Controls - half (12 o'clock)
- Local XLR Mic/Line switch - source dependant
- Master Volume - off
- Mic level - half (9 o'clock)
- Prog level - half (9 o'clock)
- Local level - half (9 o'clock)

12 o'clock



9 o'clock



### Step by Step Setup

Confirm the initial settings of DigiPage.

Choose a zone that is conveniently located near to the DigiPage or further away if you feel you need the exercise. This will be referred to as the "TEST ZONE".

Ensure that all amplifiers connected to the DigiPage are set to provide required sound levels with a line level input signal.

Choose a consistent program source, eg CD or tuner. This will be referred to as "TEST PROG".

- 1 Select TEST PROG in the TEST ZONE [front PROG 1-6].  
Set the MASTER volume in the TEST ZONE to half way.
- 2 Adjust the rear PROG GAIN for the TEST PROG input to achieve the required sound level in the TEST ZONE.
- 3 Select PROG TEST in all other zones.
- 4 Bring up the MASTER volume in all other zones and check for required sound levels.
- 5 Do a test page in the TEST ZONE and check the level relative to the program level.
- 6 Adjust the page level as desired [front panel PAGE].
- 7 Set the input level type of any local inputs being used [rear panel LOCAL MIC/LINE].
- 8 Select and check the local inputs in each zone.  
Adjust the local level as desired [front panel LOCAL].
- 9 Balance the other program sources in the TEST ZONE [rear panel PROG GAIN]
- 10 Apply the front panel settings from TEST ZONE to all other zones.
- 11 Using the front panel controls only, set the individual zones to your preferred settings
  - a. Set balance between local/prog/page
  - b. Set Eq
  - c. Set final master level



**NOTE:** A full discussion of setting up a complex system with correct gain structure is beyond the scope of this manual. The procedure above assumes that the installer has correctly set up external equipment connected to DigiPage prior to initiating the set up procedure.



<b>Trouble</b>	<b>Likely Cause</b>	<b>Remedy</b>
<b>DigiPage System</b>		
No response to controls	Mains brownouts or incorrect connection of devices may cause processor to lock-up	Cycle power on the DigiPage
Poor signal to noise ratio	Incorrect system gain structure	- Check settings of all equipment - Revisit Step-by-Step Setup Procedure
	Lack of system ground	See Grounding in Installation section
All Call works but Zone Page does not	Main unit set to slave	Set main unit master/slave switch to master (switch in)
<b>Paging Station</b>		
LED's chase	Initialisation (boot) sequence	Normal operation when power is applied
Inconsistent operation	Cable too long	See Installation section
	Cable fault	- Check cable. - Check Paging Station with good cable at DigiPage
Emits high-pitch whine	Station lock-up due to connection while system is live	With all Paging Stations connected, cycle power on the DigiPage
<b>Remote Control Panel</b>		
No effect: busy LED blinks	Actually controlling a different zone	Program correctly (factory setting is zone 1)
Busy LED never blinks	Cable fault	- Check cable - Check Remote Panel with good cable at DigiPage
Busy LED on	Another device has control of the zone	- Check other units - Cycle power if suspect system lock-up



# LINKING TWO DIGIPAGE SYSTEMS

DigiPage is fully expandable to form a 16 zone paging system by the simple linking of two units. One DigiPage is then designated the master unit, driving zones 1-8, with the slave unit driving zones 9-16. The following settings and connections are required to form a linked DigiPage system.

The DigiPageM16 paging station must be used to access all zones.

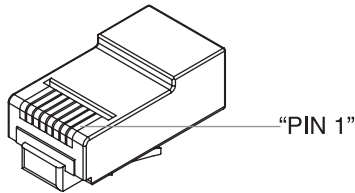

## Program Source Wiring

### 568A Configuration

Pin	Wire Colour	Prog Wiring
1	White/Green	Prog 1
2	Green	Prog 2
3	White/Orange	Prog 3
4	Blue	Prog 4
5	White/Blue	Prog 5
6	Orange	Prog 6
7	White/Brown	Ground
8	Brown	Ground

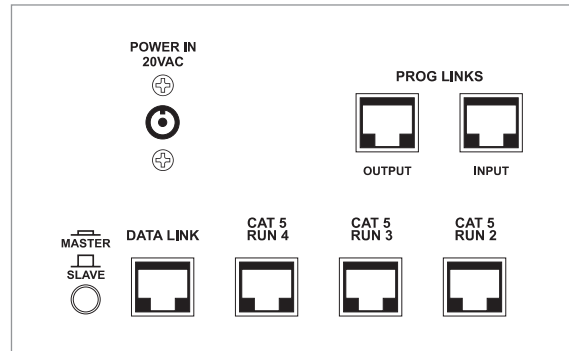

## Master/Slave

This switches the unit from master (switch in) to slave (switch out). When set as master the unit acts as zones 1 to 8. When set as slave the unit acts as zones 9 to 16. **This switch should only be operated when the unit is powered off.**

## Data Link

This link is essential. Use a pre-wired CAT5 patch lead. The maximum cable length for the data link cable is 10m, but note that PROG LINKS cable is limited to 0.5m (see below).

**NOTE:** Maximum data link cable length is 10m

**NOTE:** These are NOT Ethernet connections.

## Prog Links

Program sources can be sent to the slave DigiPage by connecting the PROG LINKS OUTPUT on the Master unit to the PROG LINKS INPUT on the Slave unit. This simplifies connection of sources as all 6 sources can be sent from the master to the slave via 1 CAT5 cable avoiding the need for Y-cables

The PROG TRIM on the slave unit operates independently of the master unit. The PROG TRIM on the slave unit should be set to the same position as on the master.

Use a pre-wired CAT5 patch lead. The maximum cable length for the program source link cable is 0.5m. However, this cable should be kept as short as possible because it is carrying audio signal.

**NOTE:** If PROG LINKS is not used, it is possible to use completely different program sources in zones 1-8 to zones 9-16.

**NOTE:** Maximum prog link cable length is 0.5m



### Changing Volume Levels

The output level is controlled by a digital up/down switch arrangement. There are 32 levels from off to maximum in a non linear audio configuration. The master LED's indicate this volume setting but because there are only 8 LED's, a change to the volume (pressing up or down) may not show a change in the LED's. The level must step 4 times before the LED indication changes.

**!** **NOTE:** The LED's are an indication of master volume setting and not an indication of signal level or presence.

### Changing Program Sources Or Local:

The program sources can be selected individually, or multiple program sources can be mixed together. Operation is as follows:

Select one program source	Press momentarily
Add another program source	Press and hold for 2 secs
Deselect program source	Press and hold for 2 secs
Turn off all program sources	Press Prog Off

Local is not affected and is controlled by toggling either on or off.

### Remembering Settings / Powering Up And Down:

The DigiPage is designed to remember it's last setting when powering down. Due to the nature of memory storage, the unit should be left on for at least 15 seconds after a change is made to allow the unit to store the changes. The unit should also be allowed to stand for 15 seconds before turning back on to allow all voltages to discharge. This is not required if cycling the mains to clear a lockup but only to ensure that changes are stored.

### Busy Signal:

When a zone is busy, the volume control and program source selection becomes inactive. Changes cannot be made while the zone is busy. A zone is made busy when a peripheral device is accessing the zone. This can be in two forms:

- 1 When someone is paging to the zone. The busy led will then glow steady.
- 2 When someone is making changes using the remote wall panel. The busy led will then blink rapidly.

**!** **NOTE:** The paging stations for the DigiPageJr are different to the DigiPage and cannot be mixed. The same applies to DPRM's which cannot be used with the DigiPageJr.



## Introduction

The Australian Monitor Installation Series DigiPage8M and DigiPage16M Paging Stations are 8 and 16 zone paging stations complete with a slimline gooseneck paging microphone. The Paging stations are designed to be used with the DigiPage Zone Paging & Source Selection System and will allow paging into any individual zone, any combination of zones or All Call to all zones. LED indicators provide the user with visual feedback of the zones being paged or if the zone selected is busy. Ample label space is provided on the Paging Station, which also provides a microphone gain control. Connection to the DigiPage is via low cost CAT 5 cable and as with all Australian Monitor installation products, the Paging Station provides an elegant solution at a contractor friendly price.

## Controls

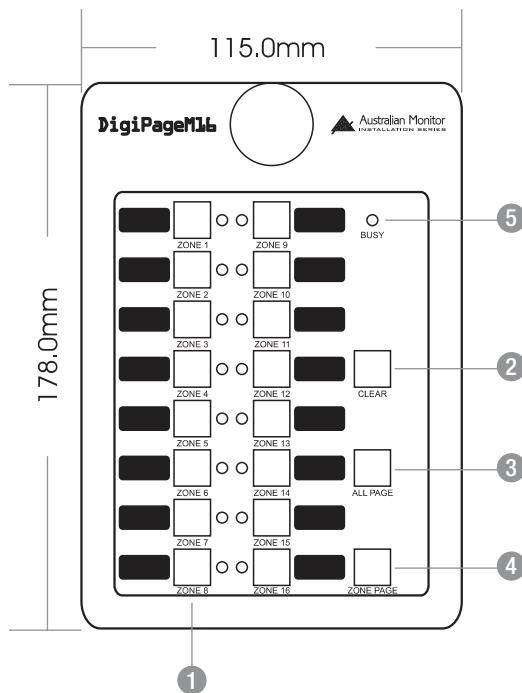

### 1 Zone Select

These buttons allow selection of zones for paging. When selected, the adjacent LED glows green. Pressing the button again deselects the zone. The area next to the button is for labelling the zone. Selecting a zone does not instigate paging. See 4. ZONE PAGE.

### 2 Clear

This button clears all the selected zones.

### 3 All Page

This button pages to all zones. It is momentary so must be held while talking into the microphone. It activates the microphone and mutes the program sources. It does NOT clear the current zone selection configuration so the paging station will return to its previous state (selected zones) once the ALL PAGE button is released.

### 4 Zone Page

This button pages to the current zone selection configuration as indicated by the ZONE select LEDs. The zones being paged have their program sources muted and the microphone becomes active. If no zones are selected the system will still show as busy when this button is pressed.

### 5 Busy

This LED glows when the network or system is busy. This can be caused by the local paging station (you are making a page), another paging station, or a remote control panel being in use. Paging is not possible while the system is busy, however zone selections can still be made.





## Installation And Setup

The CAT5 cable connects to the RJ45 socket on the rear panel of the paging station. This socket is a NEUTRIK™ connector designed to be used with the XLR style housing (model NE8MC) to improve reliability. Normal RJ45 connectors can also be used.

Plugging and unplugging the cable while the system is powered up may result in the system locking up and is not recommended. If this should happen, reset the DigiPage by switching off, then on.

## Base Plate Section

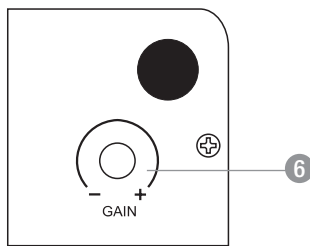

### 6 Gain

To accommodate different speech levels, there is a gain control on the base of the DigiPageM. This ships set to minimum and may be adjusted to suit. Increasing this control too far may cause the paging station to distort if loud or close speech levels are encountered.

### 7 Terminating

In an RS485 network (of which the DigiPage is part of) it is important to terminate the last device in each CAT5 RUN. Two jumpers are provided for the data transmission and the voice transmission to be terminated if that Paging Station is at the end of a CAT5 RUN (see diagram). Shipped as terminated.

When making changes be sure to power off the system and disconnect from the network.

**NOTE:** these stations are not compatible with the DigiPageJr network system.

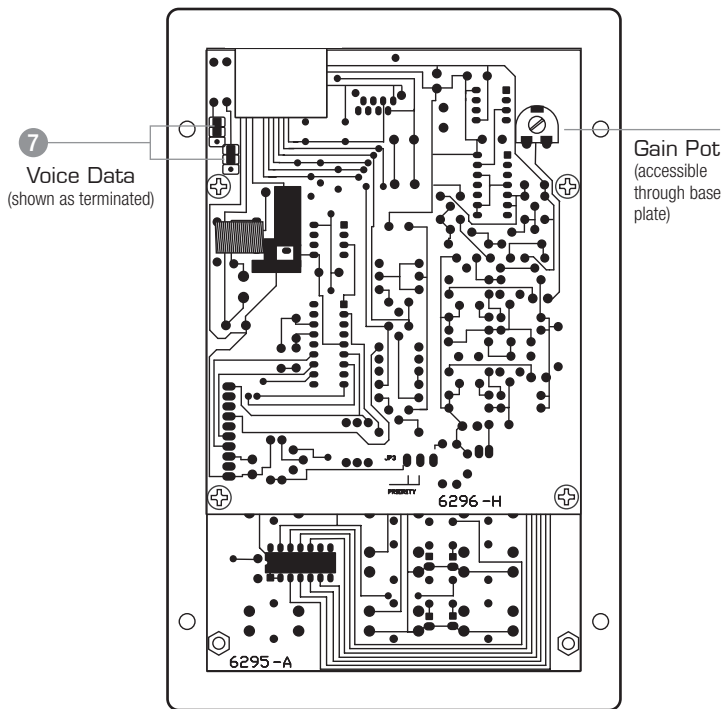



# REMOTE CONTROL PANEL

## Introduction

The Australian Monitor Installation Series DPRM Remote Control Panel is a control surface that is designed to be used with the DigiPage Zone Paging and Source Selection System. The DPRM allows control over program source selection, local input selection and volume control from a remote location. LED illumination provides the user with visual feed back if the system is busy. Connection to the DigiPage is via low cost CAT 5 cable and as with all Australian Monitor Installation products, the Remote Control Panel provides an elegant solution at a contractor friendly price.

## Controls

All the controls correspond only to the zone for which the panel is programmed by the installer. (see programming section)

### 1 Prog 1-6

This row of 6 buttons selects the numbered program source. They are electrically interlocking meaning that selecting one source will deselect the previously selected source.

### 2 Prog Off

This button will turn off the program source that is currently selected .

### 3 Local On/Off

This button toggles the local input on or off.

### 4 Busy

This LED lights when the system network is busy. The remote control panel is disabled while the system is busy unless it is the panel in use generating the busy indication.

### 5 Volume Up/Down

These two buttons increase or decrease the volume within the zone.

### 6 Terminating

In an RS485 network (of which the DigiPage is part of) it is important to terminate the last device in the network CAT5 RUN. A jumper is provided for the data transmission to be terminated if that Remote Control Panel is at the end of a CAT5 RUN. Shipped as terminated.

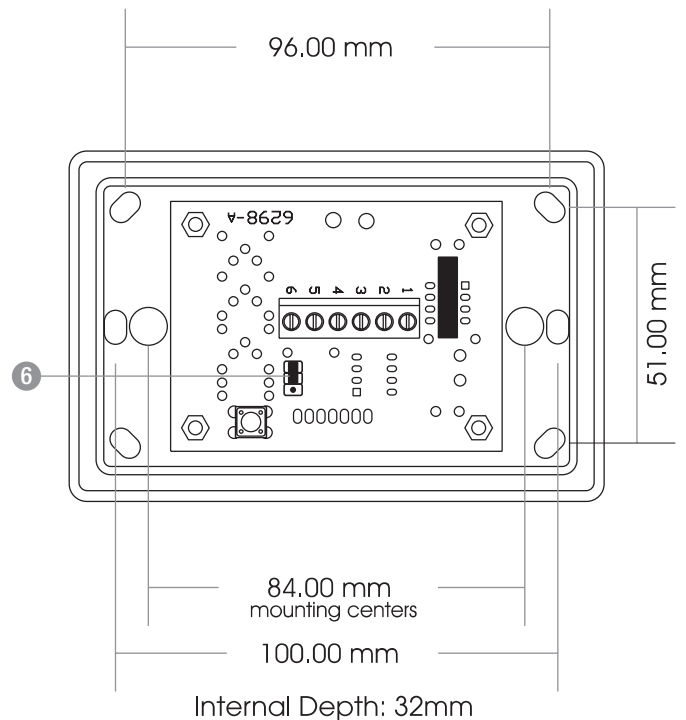
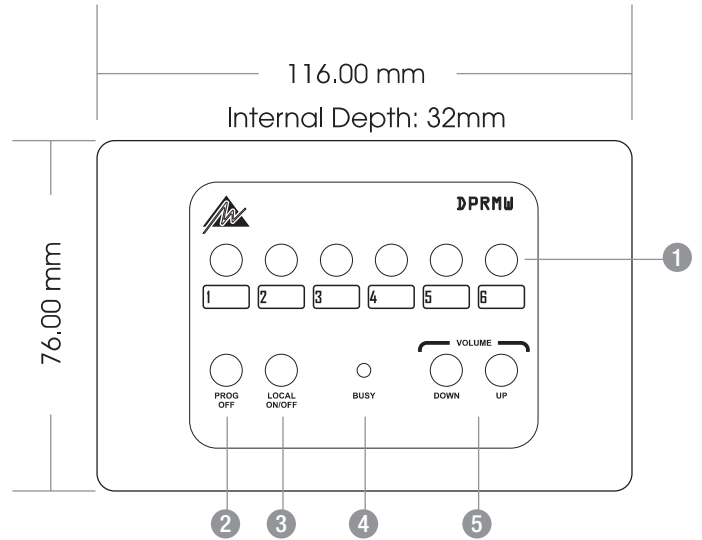



## Installation

The CAT5 cable connects to the screw terminals numbered 1-6. These numbers correspond to the pins of the RJ45 connector on the main unit. If following the 568A convention, the wire colours are wired as:

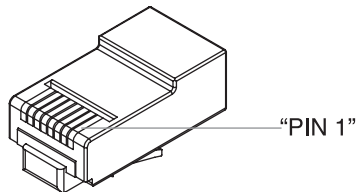

Pin	Wire Colour	DP Network
1	White/Green	Ground
2	Green	+18V
3	White/Orange	Data+
4	Blue	Busy-
5	White/Blue	Busy+ (+18V)
6	Orange	Data-
7	White/Brown	Spare
8	Brown	Spare

Ensure that the spare pair cannot short to anything.

**NOTE:** If the Remote Control Panel is NOT the last unit in the CAT5 RUN and there are paging stations connected further down the run it is important that the spare pair is continued to the next unit otherwise voice information from the paging stations will not get to the main DigiPage unit.

There are two holes available adjacent to the terminal block for securing the CAT5 cable with a cable tie.

## Programming

The following steps are for programming the remote control panel for use in ZONE X:

- 1 Hold down the RESET button on the back.
- 2 While holding down the RESET button, hold down both the Up and Down volume buttons.
- 3 Release the RESET button.
- 4 The remote control panel will beep 3 times indicating it is in program mode. The BUSY LED will stay lit while in program mode.
- 5 Press the Up button X times (the unit will beep each time).  
Eg. for ZONE 4, press 4 times
- 6 Press the Down button.
- 7 The BUSY LED will go out. The remote control panel is now programmed.
- 8 Confirm that the panel is controlling the correct zone.

**NOTE:** You have approx. 2 secs to begin the programming and between button presses else it will exit programming mode.



# BLOCK DIAGRAM

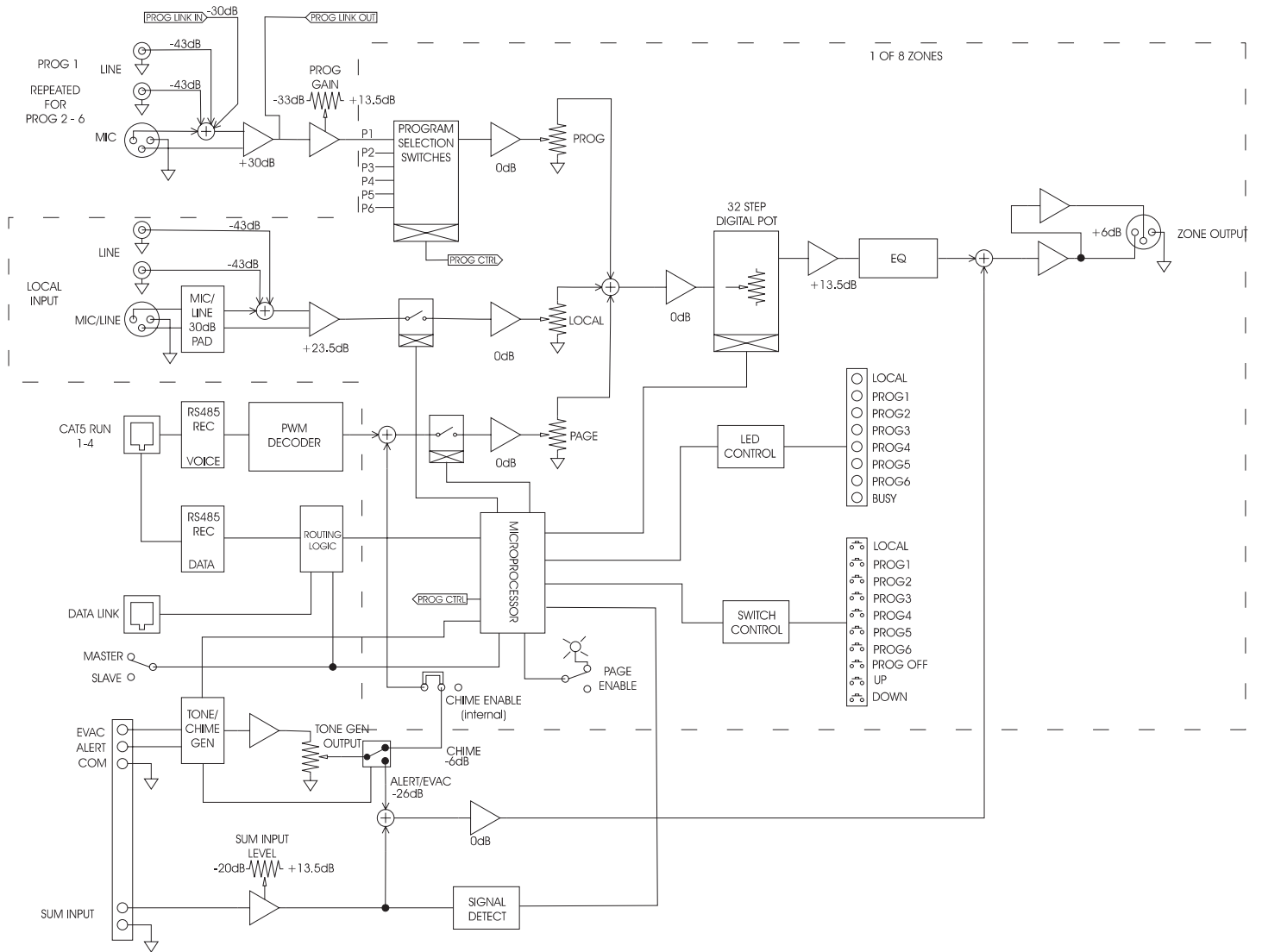

**PAGING STATIONS**

8 ZONE	Cat No. DP8M
16 ZONE	Cat No. DP16M

**REMOTE CONTROL PANELS**

BLACK	Cat No. DPRMB
WHITE	Cat No. DPRMW

**INPUT PLATE**

BLACK	Cat No. DPRIPB
WHITE	Cat No. DPRIPW

**STANDOFF SURFACE MOUNT BOX**

BLACK	Cat No. DPRMSMBB
WHITE	Cat No. DPRMSMBW



## SPECIFICATIONS

<b>FREQUENCY RESPONSE (0dB/-3dB)</b>	15Hz - 17kHz
<b>THD</b>	0.05%
<b>NOISE</b>	Page Mic: -84dB Other Inputs: -89dB
<b>SUM INPUT</b>	Input Sensitivity: 160mV (-13.5dBu) Threshold: -46dBu (at output, indpt of input)
<b>OUTPUT</b>	1.5Vrms 600 Ohm Max: 9Vrms
<b>LOCAL SOURCE</b>	
<b>Unbalanced (RCA)</b>	Input Impedance: 100k Ohm Sensitivity: 1.55V (+6dBu)
<b>Balanced (XLR)</b>	
<b>Mic</b>	Input Impedance: 1k3 Ohm Sensitivity: 11mV (-37dBu)
<b>Line</b>	Input Impedance: 45k Ohm Sensitivity: 350mV (-7dBu)
<b>PROGRAM SOURCES (TRIM MAX)</b>	
<b>Unbalanced (RCA)</b>	Input Impedance: 100k Ohm Sensitivity: 150mV (-14dBu)
<b>Balanced (XLR)</b>	Input Impedance: 1k3 Ohm Sensitivity: 1mV (-57dBu) Min Trim: -46dB
<b>POWER INPUT</b>	20V AC or 24V DC 1.5A via 2.1mm x 5.5mm barrel socket
<b>POWER CONSUMPTION (MAX)</b>	30VA
<b>DIMENSIONS (W x D x H)</b>	483mm x 180.5mm x 133mm (19" x 7.1" x 5.24")
<b>SHIPPING DIMENSIONS (W x D x H)</b>	537mm x 255mm x 258mm (21.1" x 10" x 10.2")
<b>WEIGHT</b>	
<b>Net Weight</b>	6kg (13.2lb)
<b>Shipping Weight</b>	7.6kg (16.8lb)

*All measurements are reference to 1.5V (+6dBu)*

DigiPage main unit

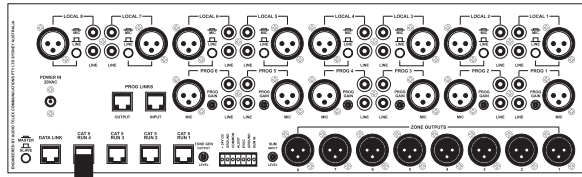

50m-1000m  
(150'-3200')

12Vdc REGULATED\*  
plug pack/power supply

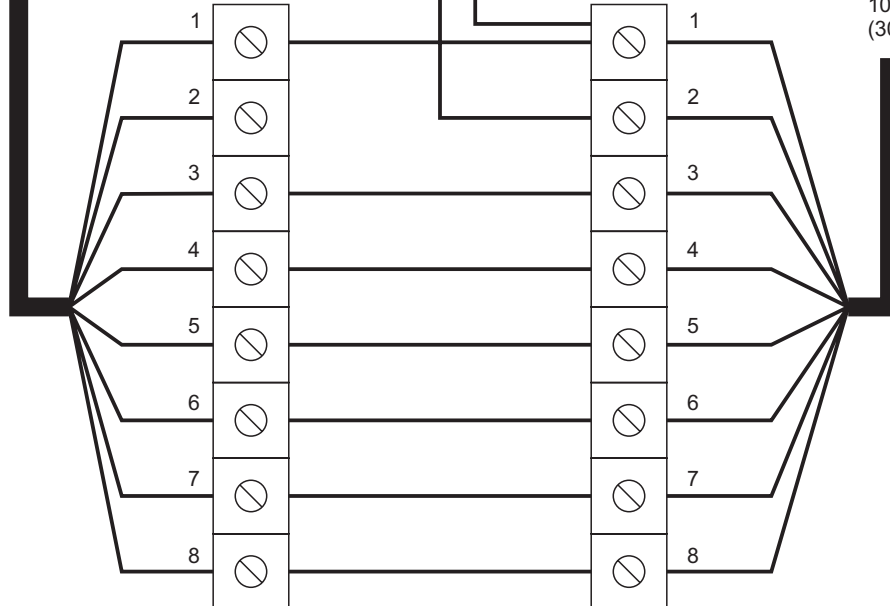
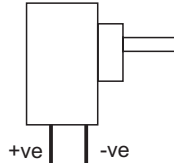

10m-50m  
(30'-150')

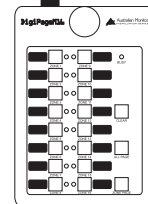

Paging Station

multiple paging stations  
can be connected this side  
(up to 32)

### CAT5 wiring

Be sure you know which configuration connectors you are using when relying on colours. If in doubt, check the connector itself. Incorrect wiring will result in damage to the DigiPage and Paging station.

### 568A CONFIGURATION

#### PIN WIRE COLOUR

- 1 White/Green
- 2 Green
- 3 White/Orange
- 4 Blue
- 5 White/Blue
- 6 Orange
- 7 White/Brown
- 8 Brown

### 568B CONFIGURATION

#### PIN WIRE COLOUR

- 1 White/Orange
- 2 Orange
- 3 White/Green
- 4 Blue
- 5 White/Blue
- 6 Green
- 7 White/Brown
- 8 Brown

\*this power supply can be any voltage from 12-18V but it MUST be regulated.



ENGINEERED BY AUSTRALIAN MONITOR

Address: Level 7, 130 Pitt Street, Sydney NSW 2000 Australia.

Website: [www.australianmonitor.com.au](http://www.australianmonitor.com.au) International enquiries email: [international@australianmonitor.com.au](mailto:international@australianmonitor.com.au)