



CMPRO-U8H8CVPL

4K2K 8x8 HDMI Matrix over CAT5e/6/7



Operation Manual

DISCLAIMERS

The information in this manual has been carefully checked and is believed to be accurate. Cypress Technology assumes no responsibility for any infringements of patents or other rights of third parties which may result from its use.

Cypress Technology assumes no responsibility for any inaccuracies that may be contained in this document. Cypress also makes no commitment to update or to keep current the information contained in this document.

Cypress Technology reserves the right to make improvements to this document and/or product at any time and without notice.

COPYRIGHT NOTICE

No part of this document may be reproduced, transmitted, transcribed, stored in a retrieval system, or any of its part translated into any language or computer file, in any form or by any means—electronic, mechanical, magnetic, optical, chemical, manual, or otherwise—without express written permission and consent from Cypress Technology.

© Copyright 2014 by Cypress Technology.

All Rights Reserved.

Version 1.0 June 2014

TRADEMARK ACKNOWLEDGMENTS

All products or service names mentioned in this document may be trademarks of the companies with which they are associated.



SAFETY PRECAUTIONS

Please read all instructions before attempting to unpack, install or operate this equipment and before connecting the power supply.

Please keep the following in mind as you unpack and install this equipment:

- Always follow basic safety precautions to reduce the risk of fire, electrical shock and injury to persons.
- To prevent fire or shock hazard, do not expose the unit to rain, moisture or install this product near water.
- Never spill liquid of any kind on or into this product.
- Never push an object of any kind into this product through any openings or empty slots in the unit, as you may damage parts inside the unit.
- Do not attach the power supply cabling to building surfaces.
- Use only the supplied power supply unit (PSU). Do not use the PSU if it is damaged.
- Do not allow anything to rest on the power cabling or allow any weight to be placed upon it or any person walk on it.
- To protect the unit from overheating, do not block any vents or openings in the unit housing that provide ventilation and allow for sufficient space for air to circulate around the unit.

REVISION HISTORY

VERSION NO.	DATE DD/MM/YY	SUMMARY OF CHANGE
RDV1	20/05/14	Preliminary Release



CONTENTS

1. Introduction	1
2. Applications	1
3. Package Contents	1
4. System Requirements	2
5. Features	2
6. Operation Controls and Functions	3
6.1 Front Panel	3
6.2 Rear Panel.....	4
6.3 Side Panel	5
6.4 Remote Control.....	6
6.5 IR Cable Pin Assignment.....	6
6.6 RS-232 Pin Assignment	7
6.7 RS-232 & Telnet Commands.....	8
6.8 Telnet Control	9
6.9 Web GUI Control	11
7. Connection Diagram	13
8. Specifications	15
9. Acronyms	16





1. INTRODUCTION

The 4K2K 8 by 8 HDMI Matrix over CAT5e/6/7 supports the transmission of video (resolutions up to 4K2K Full HD), multi-channel digital audio and control via IR, RS-232, Telnet or Web GUI from eight high definition sources to eight outputs over a single CAT5e/6/7 cable (up to 60m) for each output.

It supports high resolution digital audio formats such as LPCM 7.1CH, Dolby TrueHD, Dolby Digital Plus and DTS-HD Master Audio as well as 3D content that can be displayed when connecting a 3D TV and 3D source.

2. APPLICATIONS

- HDMI Matrix System
- Video/TV wall display and control
- Security surveillance and control
- Commercial advertising, display and control
- University lecture hall, display and control
- Retail sales and demonstration

3. PACKAGE CONTENTS

- 4K2K 8×8 HDMI Matrix over CAT5e/6/7
- 9×IR Blaster
- 1×24V/6.25A DC Power Adaptor
- 2×Power Cable
- 1×IR Remote Control
- Operation Manual

4. SYSTEM REQUIREMENTS

- HDMI equipped source devices, connect with HDMI cables or DVI equipped source, connect with DVI to HDMI cables
- HDMI equipped displays (TVs or monitors) or HDMI equipped AV receivers, connect with HDMI cables
- Industry standard CAT5e/6/7 cables
- HDBaseT™ Receivers

5. FEATURES

- HDMI, HDCP 1.1 and DVI compliant
- Supports resolutions VGA~WUXGA, 4K2K@24/25/30 & YUV_420 and 480i~1080p dependent upon the output display's EDID settings
- Supports distances up to 60 meters through CAT6/7 cables
- Supports 3D signal display dependent upon the output display EDID settings
- Supports PoC (Power over Cable) on compatible receivers only
- Supports HDMI input up to 15 meters at 8-bit resolution or 10 meters at 12-bit resolution
- Supports bi-directional IR from input and output locations
- Supports RS-232, remote control, on-panel control and IP Control (Telnet & Web GUI)
- 2U size design
- Supports external and internal EDID settings
- Supports LPCM 7.1CH, Dolby TrueHD, Dolby Digital Plus and DTS-HD Master Audio transmission

Note:

- 1. The PoC function is designed for powering compatible receiver units only—non-PoC receivers will need their own power supply. Receivers of another brand may not be compatible.*
- 2. Do not connect the LAN port to CAT outputs of this device or to CAT inputs or receiver. Doing so may damage the unit.*

6. OPERATION CONTROLS AND FUNCTIONS

6.1 Front Panel

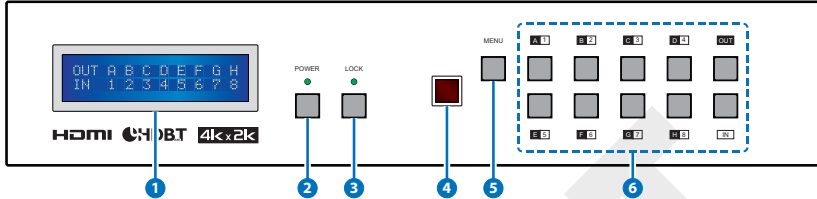

- ❶ **LCM** : Displays the setting information of each input and output setting.
- ❷ **POWER**: Press this button to power the device on/off. The LED will illuminate green when the power is on, red when it is in 'Standby' mode.
- ❸ **LOCK**: Press this button for 3 seconds to lock all the buttons on the panel; press again for 3 seconds to unlock. The LED will illuminate green when locked.
- ❹ **IR**: IR Receiver window (accepts the remote control signal of this device only).
- ❺ **MENU**: Press this button to access the LCM menu system, from here EDID settings can be managed and IP system settings are displayed.
- ❻ **1~8/A~H and In/Out**: Press the Out or In button to select the output or input mode and then press the required number button to make the selection accordingly.

For example, if outputs A~D need to be set to input 1 and outputs E~H need to be set to input 2, then the following sequence of button presses need to be performed:

Press: Out → A → B → C → D → In → 1 → Menu,
and then press: Out → E → F → G → H → In → 2 → Menu.

Note: If the menu button is not pressed the selection will not be changed.

6.2 Rear Panel

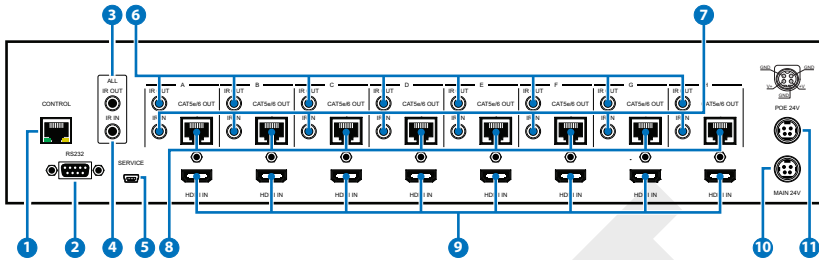

- 1 CONTROL:** Web GUI control (refer to Sections 6.8 and 6.9).
- 2 RS-232:** Connect to a PC or control system with D-Sub 9-pin cable for the transmission of RS-232 commands.
- 3 ALL IR OUT:** Connect to the IR blaster for IR signal transmission to the source side. Place the IR blaster in direct line-of-sight of the equipment to be controlled for it will blaster out all signal received from the IR IN at the receiver sides.
- 4 ALL IR IN:** Connect to the IR extender for IR signal reception. Ensure that remote being used is within the direct line-of-sight of the IR extender for it will send out the signal to all receiver's IR OUT.
- 5 SERVICE:** Manufacturer use only.
- 6 IR OUT 1~8:** Connect to the IR blasters for IR signal transmission. Place the IR blaster in direct line-of-sight of the equipment to be controlled for it will blaster out the IR signal received from the receiver side chosen by input selection.
- 7 IR IN 1~8:** Connect to the IR extenders for IR signal reception. Ensure that remote being used is within the direct line-of-sight of the IR extender for it will send out the IR signal to the selected receiver's IR OUT.
- 8 CAT5e/6/7 OUT 1~8:** Connect from these CAT outputs to the CAT input port of the receiver units with a single CAT5e/6/7 cable for HDMI Audio/Video and IR/RS-232 control signal transmission.
- 9 HDMI IN 1~8:** Connect to the HDMI input source devices such as a DVD player or a Set-top Box with HDMI cable or DVI to HDMI cable.
- 10 DC 24V MAIN POWER:** Plug the 24 V DC power supply into the unit and connect the adaptor to an AC outlet.

- 11 PoC 24V:** Plug the 24 V PoC power supply into the unit and connect the adaptor to an AC outlet. This unit will power PoC (Power over Cable) capable receiver units.

Warning: Please do not connect the CAT5e/6/7 cable into the receiver's LAN port.

6.3 Side Panel

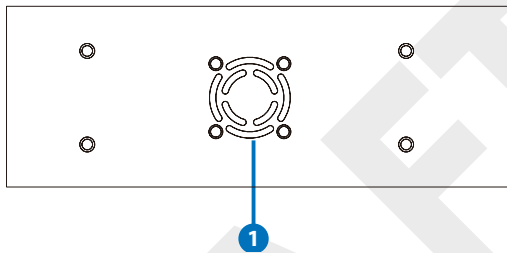

- 1 Fan Ventilator:** These are air ventilation areas, DO NOT block these areas or cover it with any object. Please allow adequate space around the unit for air circulation.

6.4 Remote Control

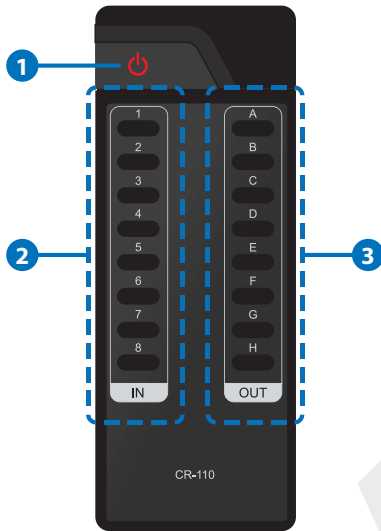

- 1 POWER:** Press this button to switch on the device or set it to standby mode.
- 2 IN:** Input ports selection 1~8.
- 3 OUT:** Output ports selection A~H.

6.5 IR Cable Pin Assignment

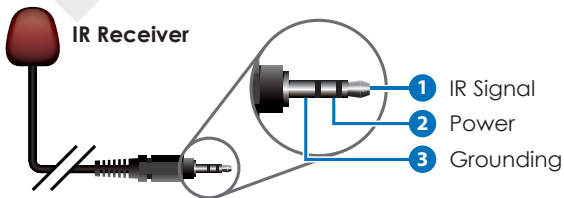
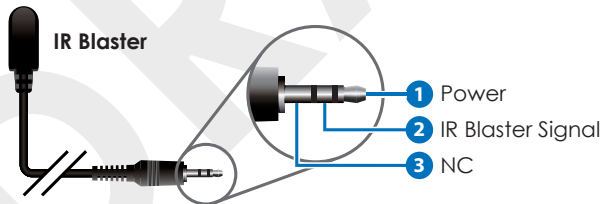

6.6 RS-232 Pin Assignment

CMPRO-U8H8CVPL			Remote Control Console	
PIN	Assignment		PIN	Assignment
1	NC		1	NC
2	Tx		2	Rx
3	Rx	→	3	Tx
4	NC		4	NC
5	GND	←	5	GND
6	NC		6	NC
7	NC		7	NC
8	NC		8	NC
9	NC		9	NC

Baud Rate: 19200 bps

Data bit: 8 bits

Parity: None

Stop Bit: 1

Flow Control: None

6.7 RS-232 & Telnet Commands

Command	Description
A1~A8	Switch Output A to 1~8
B1~B8	Switch Output B to 1~8
C1~C8	Switch Output C to 1~8
D1~D8	Switch Output D to 1~8
E1~E8	Switch Output E to 1~8
F1~F8	Switch Output F to 1~8
G1~G8	Switch Output G to 1~8
H1~H8	Switch Output H to 1~8
ABCD...1~ABCD...8	Switch Output A B C D... to 1~8 at the same time
SETIP <IP> <SubNet> <GW>	Setting IP. SubNet. GateWay (Static IP)
RSTIP	IP Configuration Was Reset To Factory Defaults <DHCP>
IPCONFIG	Display the current IP config
P0	Power OFF
P1	Power ON
I1~I8	Switch all the Output to 1~8
ST	Display the current matrix status and F/W version
RS	System Reset to A1, B2, C3, D4, E5, F6, G7, H8
EM	Setting EDID MODE. 1-STD 2-TV
?	Display all the available commands
Quit	Exit(for telnet only)

Note: Any commands will not be executed unless followed by a carriage return. Commands are case insensitive.

6.8 Telnet Control

Before attempting to use the telnet control, please ensure that both the Matrix (via the 'LAN' port) and the PC/Laptop are connected to the active networks.

To access the telnet control in Windows 7, click on the 'Start' menu and type "cmd" in the Search field then press enter.

Under Windows XP go to the 'Start' menu and click on "Run", type "cmd" with then press enter.

Under Mac OS X, go to Go→Applications→Utilities→Terminal

See below for reference.

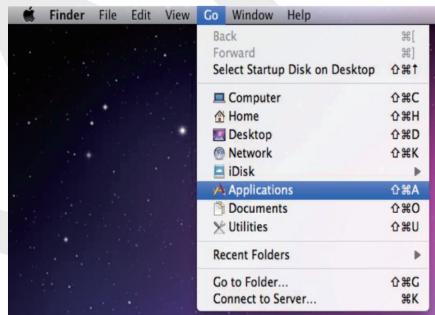

Once in the command line interface (CLI) type "telnet", the IP address of the unit you wish to control and "23", then hit enter.

Note: The IP address of the Matrix can be displayed on the device's LCM monitor by pressing the Menu button twice/three times.

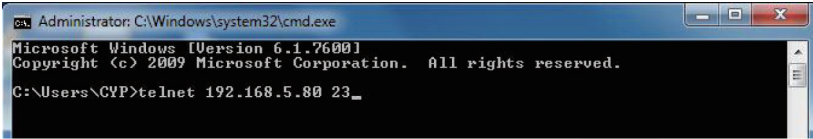

```
Administrator: C:\Windows\system32\cmd.exe
Microsoft Windows [Version 6.1.7600]
Copyright (c) 2009 Microsoft Corporation. All rights reserved.
C:\Users\CYP>telnet 192.168.5.80 23_
```

This will bring us into the device which we wish to control. Type "HELP" to list the available commands.

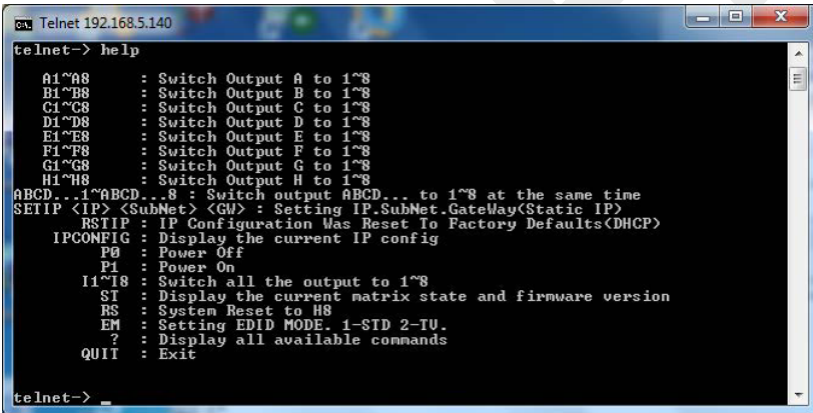

```
Telnet 192.168.5.140
telnet-> help
A1~B8      : Switch Output A to 1~8
B1~B8      : Switch Output B to 1~8
C1~C8      : Switch Output C to 1~8
D1~D8      : Switch Output D to 1~8
E1~E8      : Switch Output E to 1~8
F1~F8      : Switch Output F to 1~8
G1~G8      : Switch Output G to 1~8
H1~H8      : Switch Output H to 1~8
ABCD...1~8 : Switch output ABCD... to 1~8 at the same time
SETIP <IP> <SubNet> <GW> : Setting IP.SubNet.GateWay(Static IP)
RSTIP      : IP Configuration Was Reset To Factory Defaults(DHCP)
IPCONFIG   : Display the current IP config
  PG       : Power Off
  P1       : Power On
  I1~I8    : Switch all the output to 1~8
  ST       : Display the current matrix state and firmware version
  RS       : System Reset to H8
  EM       : Setting EDID MODE. 1-STD 2-IV.
  ?        : Display all available commands
  QUIT     : Exit
telnet-> _
```

Type "IPCONFIG" To show all IP configurations. To reset the IP, type "RSTIP" and to use a set static IP, type "SETIP" (For a full list of commands, see Section 6.7).

Note: Any commands will not be executed unless followed by a carriage return. Commands are not case-sensitive. If the IP is changed then the IP Address required for Telnet access will also change accordingly.



6.9 Web GUI Control

On a PC/Laptop that is connected to the same active network as the Matrix, open a web browser and type device's IP address on the web address entry bar. The browser will display the device's status, control and User setting pages.

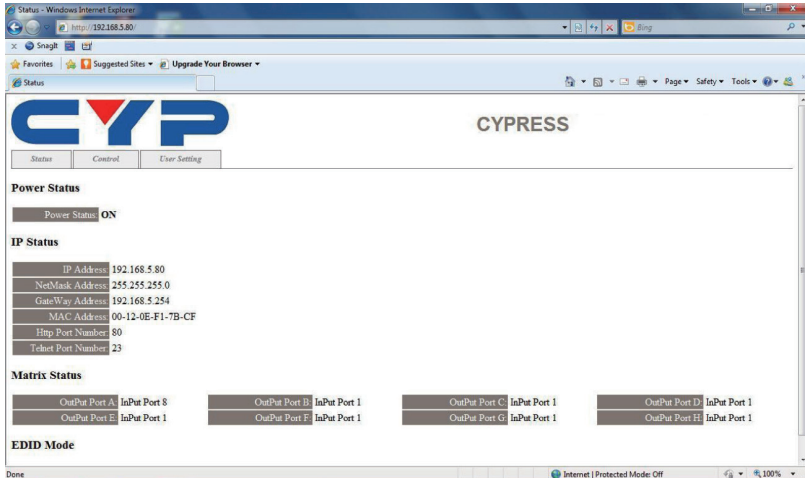

Click on the 'Control' tab to control power, input/output ports, EDID and reset mode.

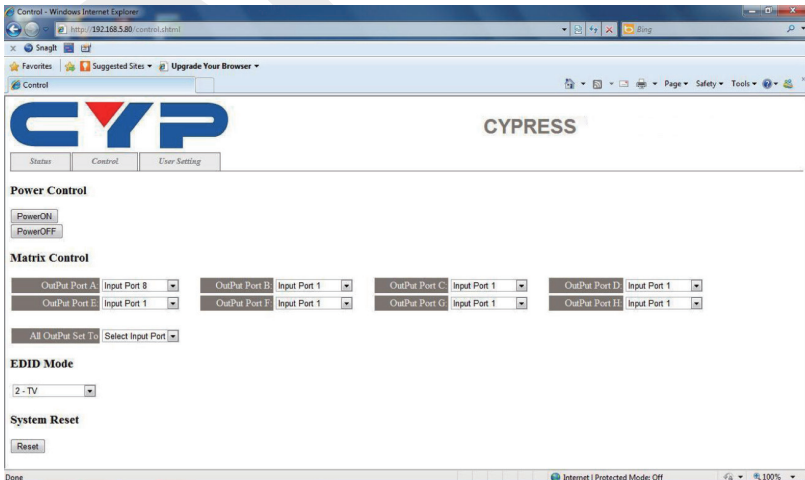

Clicking on the 'User Setting' tab allows you to reset the IP configuration. The system will ask for a reboot of the device every time any of the settings are changed. The IP address needed to access the Web GUI control will also need to be changed accordingly on the web address entry bar.

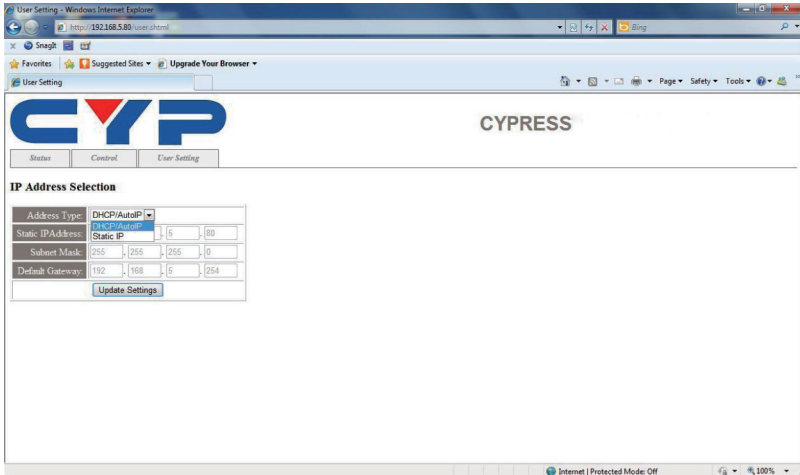

7. CONNECTION DIAGRAM

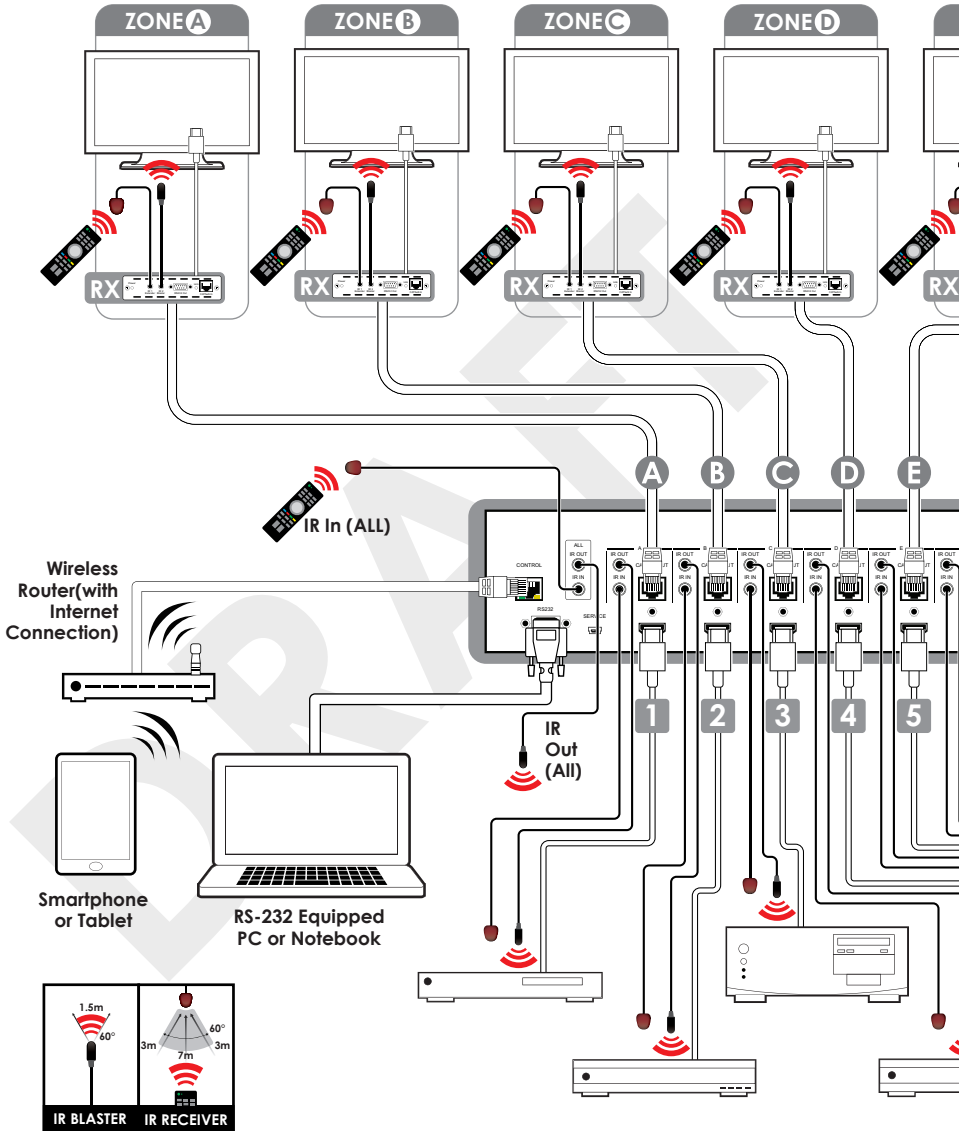

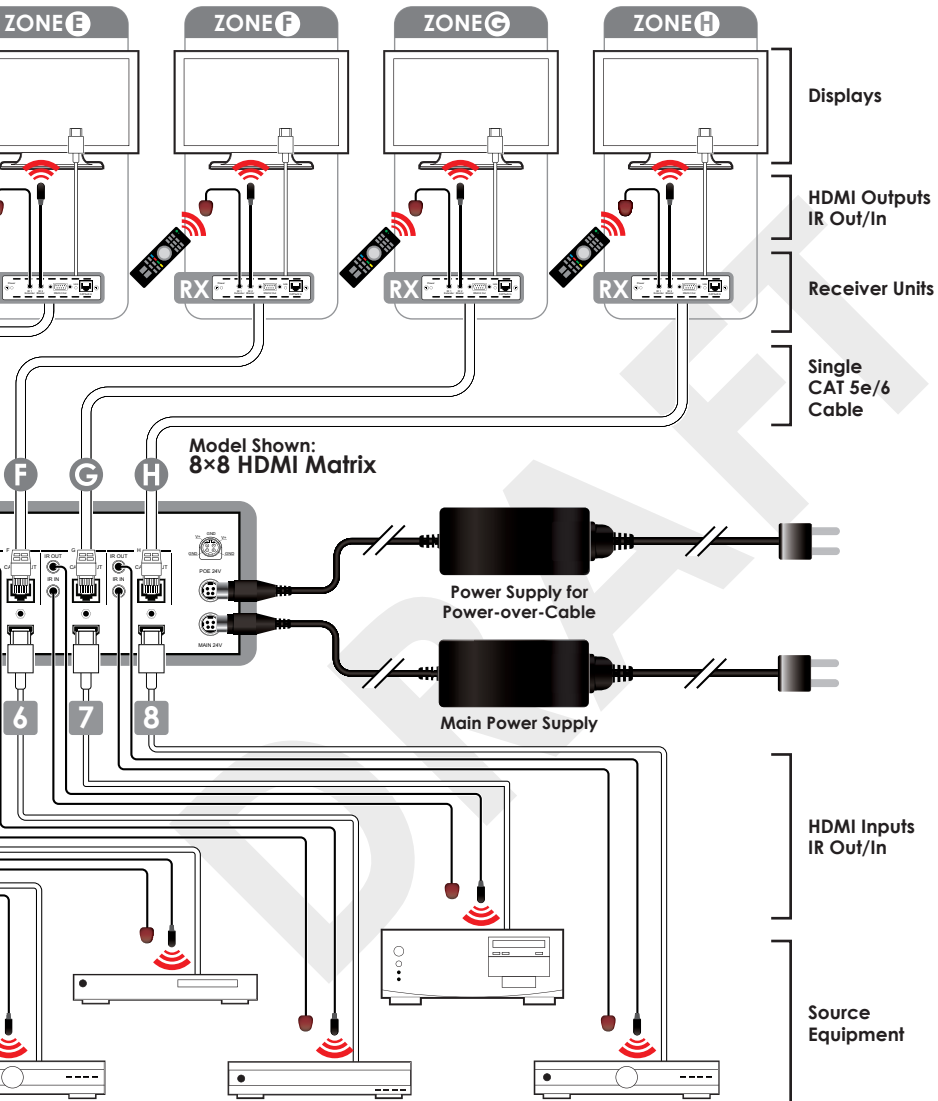



8. SPECIFICATIONS

Video Bandwidth	300 MHz/9 Gbps
Input Ports	8×HDMI, 9×IR Extender, 1×RS-232, 1×LAN, 1×Mini USB-B type (for firmware update only)
Output Ports	8×CAT5e/6/7, 9×IR
ESD Protection	Human-body Model: ± 8kV (Air-gap discharge) ± 4kV (Contact discharge)
Power Supply	24V/6.25A DC (US/EU standards, CE/FCC/ UL certified)
Dimensions	438 mm (W)×235 mm (D)×88 mm (H)/Jacks Excluded 438 mm (W)×249 mm (D)×93 mm (H)/Jacks Included
Weight	4402g
Chassis Material	Metal
Silkscreen Color	Black
Operating Temperature	0 °C~40 °C/32 °F~104 °F
Storage Temperature	-20 °C~60 °C/-4 °F~140 °F
Relative Humidity	20~90% RH (non-condensing)
Power Consumption	65 W Tx (Main), 56 W Rx (PoE)

9. ACRONYMS

ACRONYM	COMPLETE TERM
CLI	Command Line Interface
DTS	Digital Theater System
DVI	Digital Visual Interface
EDID	Extended Display Identification Data
GUI	Graphical User Interface
HDCP	High-bandwidth Digital Content Protection
HDMI	High-Definition Multimedia Interface
HDTV	High-Definition Television
LCM	Liquid Crystal Module
USB	Universal Serial Bus
VGA	Video Graphics Array
WUXGA	Widescreen Ultra Extended Graphics Array

DRAFT



CYPRESS TECHNOLOGY CO., LTD
Home page: <http://www.cypress.com.tw>

MPM-CMPROU8H8CVPL