



CMX-12

HD/SD Digital AV Mixer



Operation Manual

DISCLAIMERS

The information in this manual has been carefully checked and is believed to be accurate. Cypress Technology assumes no responsibility for any infringements of patents or other rights of third parties which may result from its use.

Cypress Technology assumes no responsibility for any inaccuracies that may be contained in this document. Cypress also makes no commitment to update or to keep current the information contained in this document.

Cypress Technology reserves the right to make improvements to this document and/or product at any time and without notice.

COPYRIGHT NOTICE

No part of this document may be reproduced, transmitted, transcribed, stored in a retrieval system, or any of its part translated into any language or computer file, in any form or by any means—electronic, mechanical, magnetic, optical, chemical, manual, or otherwise—without express written permission and consent from Cypress Technology.

© Copyright 2011 by Cypress Technology.

All Rights Reserved.

Version 1.1 August 2011

TRADEMARK ACKNOWLEDGMENTS

All products or service names mentioned in this document may be trademarks of the companies with which they are associated.





SAFETY PRECAUTIONS

Please read all instructions before attempting to unpack, install or operate this equipment and before connecting the power supply.

Please keep the following in mind as you unpack and install this equipment:

- Always follow basic safety precautions to reduce the risk of fire, electrical shock and injury to persons.
- To prevent fire or shock hazard, do not expose the unit to rain, moisture or install this product near water.
- Never spill liquid of any kind on or into this product.
- Never push an object of any kind into this product through any openings or empty slots in the unit, as you may damage parts inside the unit.
- Do not attach the power supply cabling to building surfaces.
- Use only the supplied power supply unit (PSU). Do not use the PSU if it is damaged.
- Do not allow anything to rest on the power cabling or allow any weight to be placed upon it or any person walk on it.
- To protect the unit from overheating, do not block any vents or openings in the unit housing that provide ventilation and allow for sufficient space for air to circulate around the unit.

REVISION HISTORY

VERSION NO.	DATE DD/MM/YY	SUMMARY OF CHANGE
VS1	25/11/11	First release
VR2	03/12/13	Support Apple Mode



CONTENTS

1. Introduction	1
2. Applications	1
3. Package Contents	1
4. System Requirements	1
5. Features	1
6. Operation Controls and Functions	2
6.1 Position/Time	2
6.2 Wipe Modes	3
6.3 Mode Control.....	4
6.4 Digital Effects	5
6.5 Adjust	6
6.6 Video Source Select.....	7
6.7 Audio/Video Mixer	8
6.8 Audio Level	9
6.9 Rear Panel	10
7. Operation	11
7.1 Basic Operation	11
7.2 Input Signal Selection and Back Color Selection	11
7.3 Video Mix.....	12
7.4 Video Wipe	12
7.5 WIPE PATTERN Selection	13
7.6 Multiple Pattern Selection	14
7.7 ONE-WAY WIPE	14
7.8 REVERSE WIPE	14
7.9 Picture-In-Picture	15
7.10 KEY	16
7.11 AUTO FADE/WIPE Selection	17
7.12 DIGITAL EFFECT.....	17
7.13 AUDIO MIXER	17
7.14 OSD ADJUST	18
8. Connector and Installation	19
8.1 Front Panel Connections	19
8.2 Rear Panel Connections.....	19
8.3 Output Resolutions	19
9. Specifications	20



1. INTRODUCTION

The CMX-12 is a high-quality Standard and High Definition Digital Audio/Video Mixer. Each input BUS supports up to 6 inputs (2×HDMI, 2×Component (SD/HD), 2×S-Video and Composite video). Effects can be added such as wipes, fades, mixes and special digital effects.

The CMX-12 can support HD or SD resolutions (480p, 576p, 720p 50/60, 1080i 50/60), most of the world's video standards (NTSC, NTSC-4.43, PAL, PAL-M, PAL-N, SECAM) and HDMI, Component, S-Video or Composite video outputs, it also supports position adjustment and recording.

The output resolution can automatically adjust to input resolution or be manually adjusted (please refer to the diagram above).

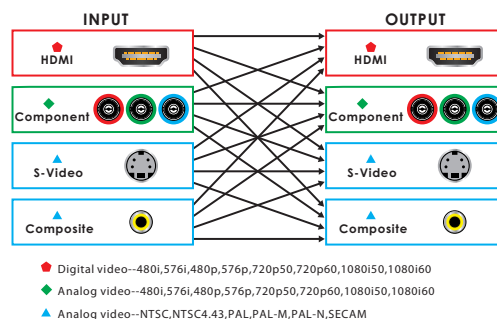

2. APPLICATIONS

- Amateur/Professional Video and Audio Mixing.

3. PACKAGE CONTENTS

- CMX-12 SD/HD Video and Audio Mixer.
- Cable Pack: 1× HDMI Cable/1× S-Video Cable/1× Stereo Audio and Composite Video Cable/1× Stereo Audio to 3.5mm Jack cable/1× Component (YPbPr) Cable.
- 1× Metal Joystick (screw attachment) for Position control.
- 12V/5.0A DC power adaptor.
- User Manual.

4. SYSTEM REQUIREMENTS

HDMI (Non-HDCP), HD (YPbPr) or SD (Composite or S-Video) Source.

HDMI (Non-HDCP), HD (YPbPr) or SD (Composite or S-Video) Recording Device.

HDMI (Non-HDCP), HD (YPbPr) or SD (Composite or S-Video) Monitor or display.

5. FEATURES

- Selective size and position for digital effects area and PIP windows.
- Automatic fade and wipe with speed preset control.
- Digital effects- Still, Mosaic, Paint and Negative.
- 96 wipe patterns.
- Chroma key & Luminance key.
- High Picture Quality.
- 3×8 back color.
- Joystick control for digital effect position.
- Fade control for Video and Audio.
- Video and Audio mixing.
- 2× HDMI source inputs.
- 2× Component (YPbPr) source inputs.
- 2× Composite and S-Video source inputs.
- 1× HDMI recording output.
- 2× Component (YPbPr) recording outputs.
- 1× Composite and S-Video recording outputs.
- 1× Composite and S-Video preview outputs with On-screen Display.
- Auxiliary audio input.

- Microphone input and headphone output.
- Picture in Picture control (3 window sizes).
- Each A/B BUS can adjust the Contrast/Brightness/Color/Hue/Detail and Aspect Ratio.
- Supports Lip-Sync delay up to 170ms.
- Composite supports 3D comb filter and YC separation.
- Motion and Edge Adaptive De-interlacing.

Note: When the selected source input is not connected or has HDCP protection, only a black screen will be displayed.

6. OPERATION CONTROLS AND FUNCTIONS

6.1 Position/Time

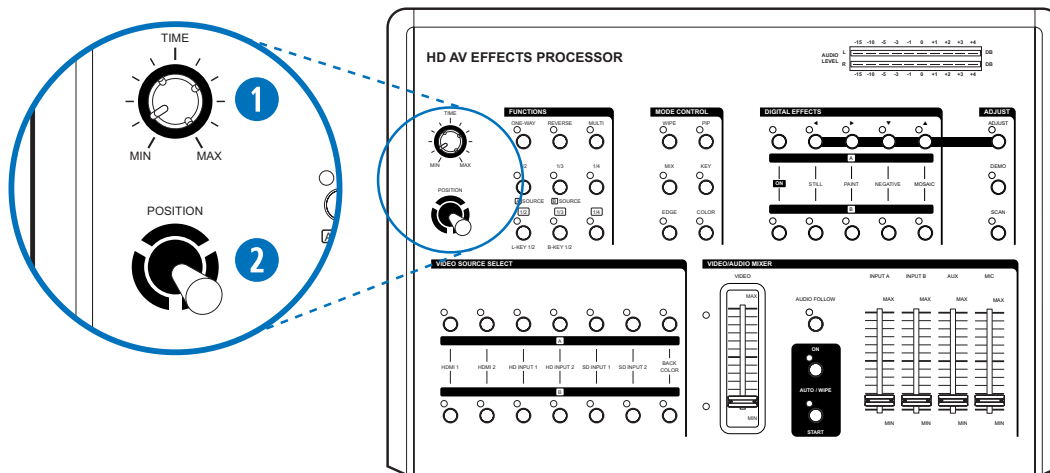

1 Time Control

For adjusting the transition time of the Auto Fade and the Auto Wipe functions.

2 Joystick control

The joystick control has two functions, it controls the position of the 'Shape' wipe pattern (button 11) and the on-screen location of the picture-in-picture box (button 13).

6.2 Wipe Modes

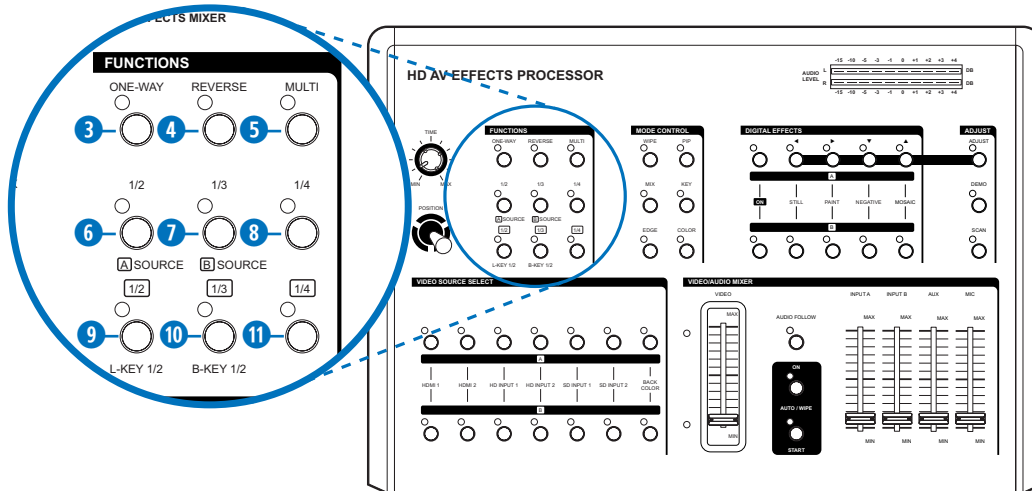

3 One-way wipe button

Selects the standard direction for the wipe pattern.

4 Reverse wipe button

Selects the reverse direction for the wipe pattern.

5 Multiple wipe button

Adds multiple wipes to the wipe pattern (up to 4 wipes).

6 Straight wipe button

Selects and toggles between 4 straight vertical or horizontal wipe patterns.

7 Split wipe button

Selects and toggles between 4 split wipe patterns.

8 Corner wipe button

Selects and toggles between 4 wipe patterns that originate from a corner.

9 Diagonal wipe button

Selects and toggles between diagonal style wipe patterns.

10 Triangle wipe button

Selects and toggles between triangle style wipe patterns.

11 Shape wipe button

Selects and toggles between 4 differently shaped wipes patterns (circle, oval, diamond and square). The position of the wipe can be adjusted using the Position Joystick (2)

6.3 Mode Control

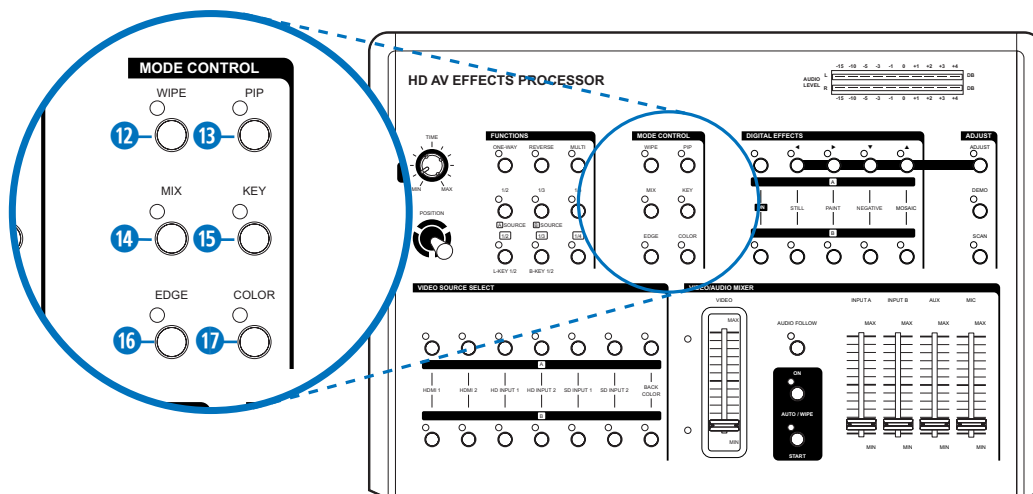

- 12 Wipe button**
Selects the wipe mode.
- 13 PIP button**
Selects the picture-in-picture mode.
- 14 Mix (Fade) button**
Selects the fade in/out mode.
- 15 KEY button**
Selects the blue key and luma key effects mode.
- 16 EDGE button**
In wipe mode, toggles between sharp/soft or colored edge.
- 17 COLOR button**
Toggles the edge colour when the EDGE button is set to coloured edge mode.

6.4 Digital Effects

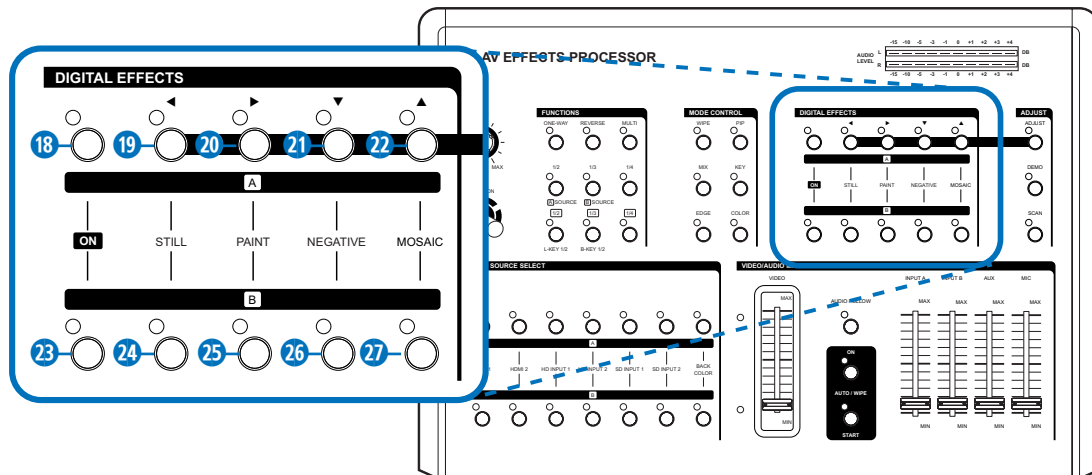

- 18 A-bus digital effect ON button.
- 19 A-bus Still button/OSD left adjust.
- 20 A-bus Paint button/OSD right adjust.
- 21 A-bus Negative button/OSD up adjust.
- 22 A-bus Mosaic button/OSD down adjust.
- 23 B-bus digital effect ON button.
- 24 B-bus Still button.
- 25 B-bus Paint button.
- 26 B-bus Negative button.
- 27 B-bus Mosaic button.

6.5 Adjust

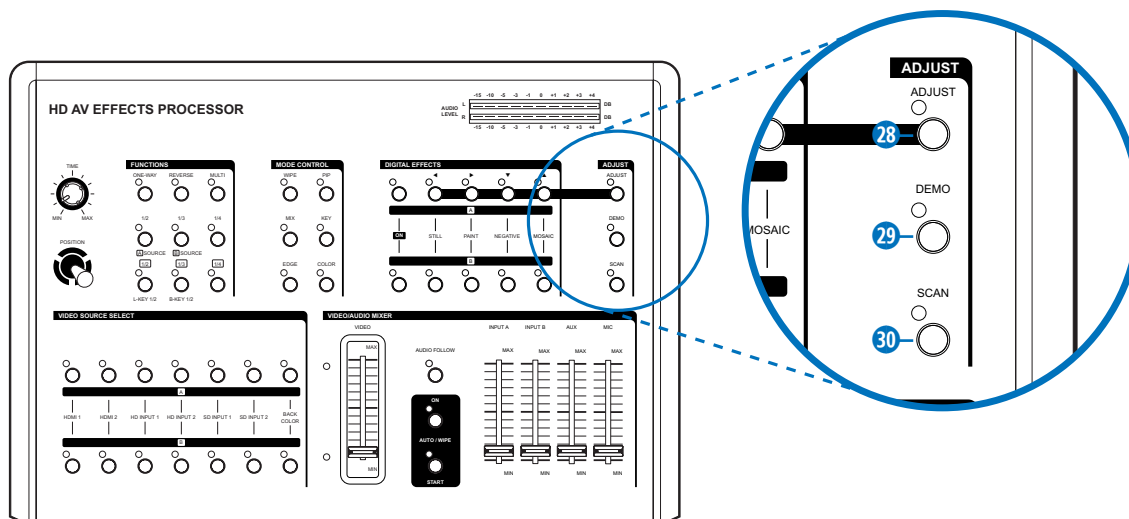

28 ADJUST button

When activated, the Setup Menu is displayed through the SD Preview output. In this mode, the menu can be navigated and values adjusted using the cursor buttons (19 ◀ 20 ▶ 21 ▼ and 22 ▲). When deactivated the SD Preview output will show A-bus/B-bus output source and format.

29 DEMO button

When pressed, this button places the unit into DEMO mode and will cycle through all 96 wipe patterns. The speed of the DEMO mode can be controlled with the Time Control (1). Press the DEMO button again to cancel DEMO mode.

30 SCAN button

If the SCAN button is pressed for 3 seconds, the system will enter SCAN mode and will SCAN the input ports from 1 to 6 and record each port's format to the system memory.

6.6 Video Source Select

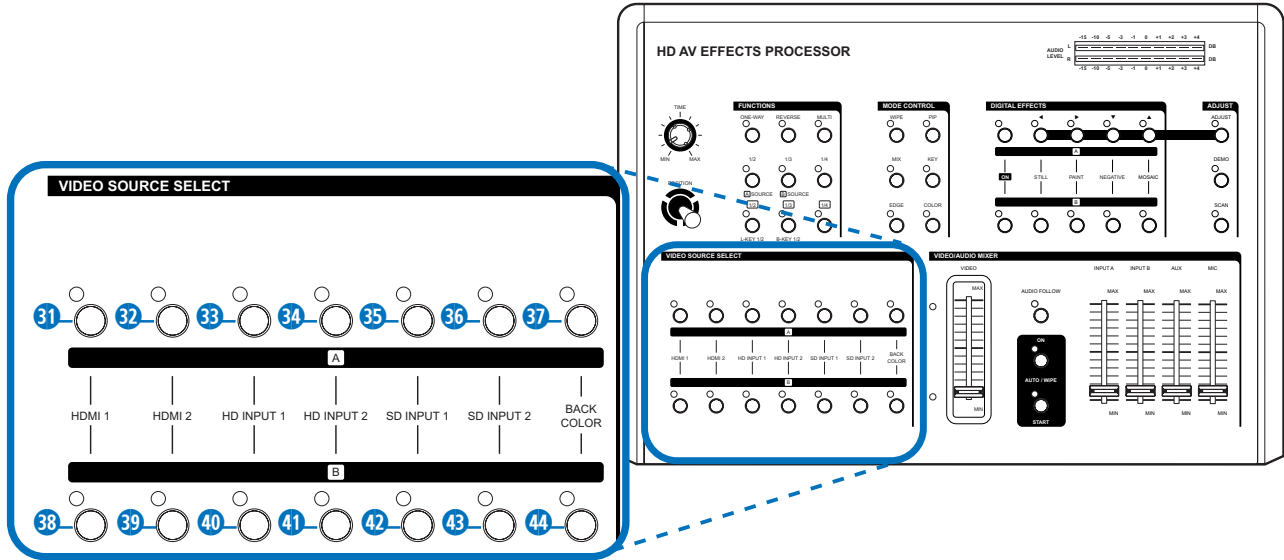

- 31/38** Selects Source 1, HDMI 1 for A-bus/B-bus. Press both keys together to allow input port HDCP support Apple mode which guarantees the use of Apple devices, both LED will illuminate.
- 32/39** Selects Source 2, HDMI 2 for A-bus/B-bus. Press both keys together to disable Apple mode, both LEDs will turn off.
- 33/40** Selects Source 3, HD input 1 for A-bus/B-bus.
- 34/41** Selects Source 4, HD input 2 for A-bus/B-bus.
- 35/42** Selects Source 5, SD input 1 for A-bus/B-bus. When both S-Video and Composite Video sources are connected at the same time, S-Video will be the first source to be displayed.
- 36/43** Selects Source 5, SD input 2 for A-bus/B-bus. When both S-Video and Composite Video sources are connected at the same time, S-Video will be the first source to be displayed.
- 37** Selects the A-bus background color, one of eight colors can be selected.
- 44** Selects the B-bus background color, one of eight colors can be selected.

6.7 Audio/Video Mixer

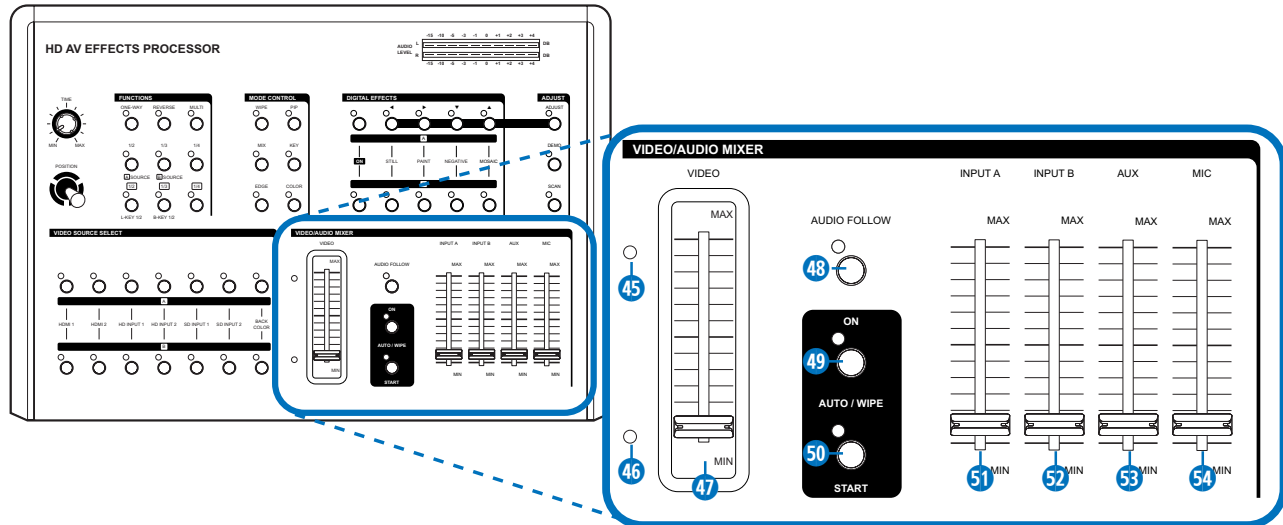

45 A-bus LED indicator/46 B-bus LED indicator

Indicates which input signal is currently in use and displayed. When the Video Slider **47** is at the top, A-bus input signal is selected/displayed and the A-bus indicator **45** is lit. When the Video Slider is at the bottom, the B-bus input signal is selected/displayed and the B-bus indicator **46** is lit. When the Video Slider is at anypoint between, the two LEDs will flash in squence to indicate that wipe/fade/mix is in progress.

47 VIDEO Slider

Controls the Wipe, PIP and Key effects. Move the slider to control the position of a wipe, the degree of fade or mix, or the strength of a Luma key or blue key effect.

48 AUDIO FOLLOW

Controls manual or automatic audio mixing. When activated the audio mix between A-bus and B-bus audio inputs is controlled by the Video Slider **47**. When deactivated, the audio mix between the A-bus and B-bus can be independently controlled **51** and **52**.

Note: AUDIO FOLLOW only affects the Input A or Input B audio mix, the AUX or MIC inputs remain unaffected.

49 AUTO/WIPE

When pressed, puts the unit into AUTO/WIPE mode and disables the Video Slider.

50 START Button

When the start button is pressed, the most recently programmed wipe/fade/mix is initiated. The TIME control **1** can be used to adjust the length of the transition. The LED will be lit for the duration of the transition and will go out when complete.

51 INPUT A

Controls the audio level of Input A.

52 INPUT B

Controls the audio level of Input B.

53 AUX

Controls the audio level of the Auxiliary input.

54 MIC

Controls the audio level of the Microphone input.

6.8 Audio Level

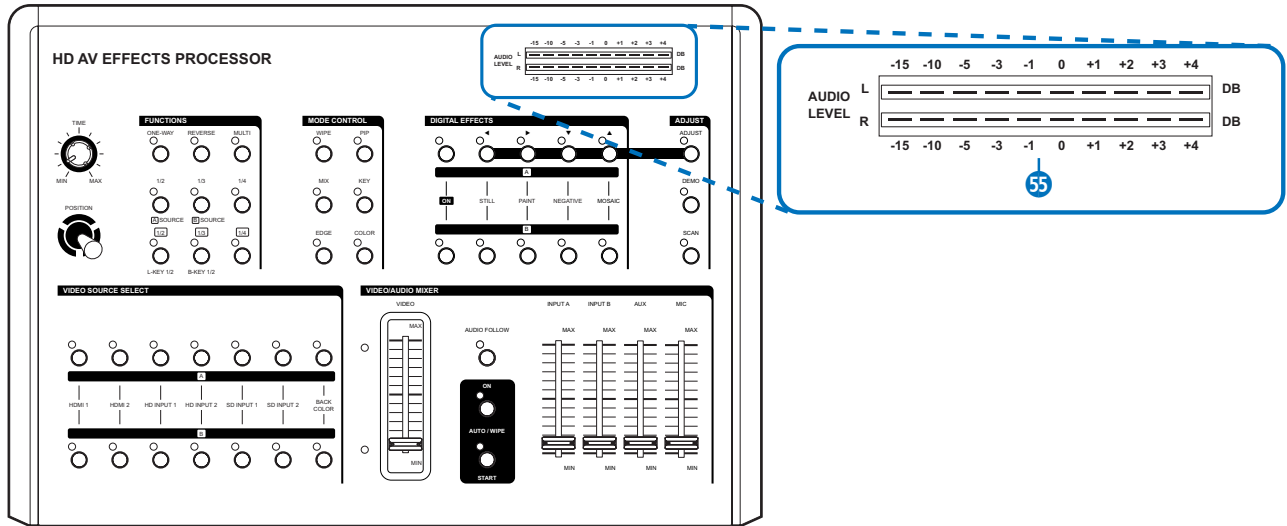

55 Audio level indicator (Audio level)

This indicator shows the audio output level of REC out 1 and REC out 2.

6.9 Rear Panel

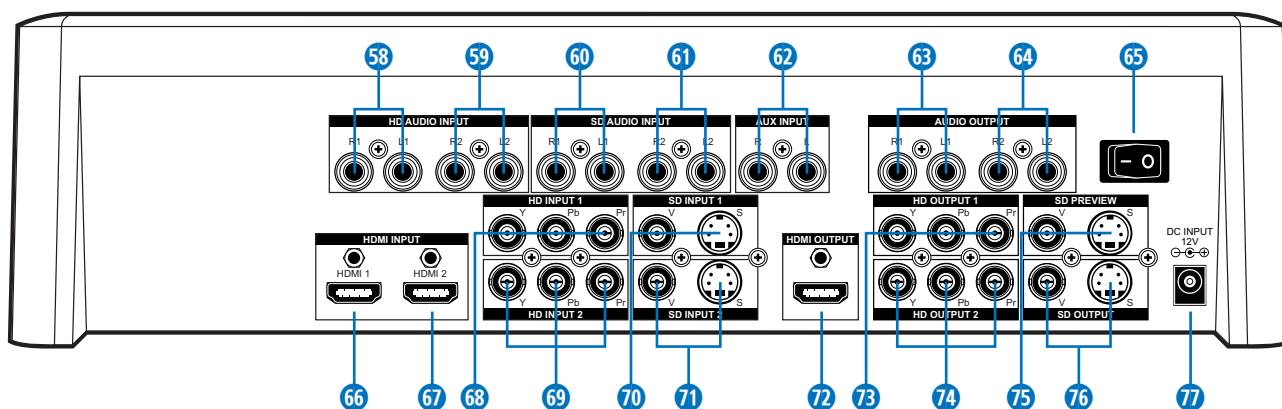

- 58 Source 3 HD audio input 1.
- 59 Source 4 HD audio input 2.
- 60 Source 5 SD audio input 1.
- 61 Source 6 SD audio input 2.
- 62 Auxiliary Audio input Jack.
- 63 Recording out 1 Audio output Jack.
- 64 Recording out 2 Audio output Jack.
- 65 Power Switch
- 66 Source 1 HDMI input 1.
- 67 Source 2 HDMI input 2.
- 68 Source 3 HD Y-PB-PR Video input 1.
- 69 Source 4 HD Y-PB-PR Video input 2.
- 70 Source 5 SD Video and YC input 1.
- 71 Source 6 SD Video and YC input 2.
- 72 HDMI output for monitor.
- 73 Recording out 1 HD YPb-Pr Video output jack.
- 74 Recording out 2 HD YPb-Pr Video output jack.
- 75 SD PREVIEW out (OSD) Video and YC output jack.
- 76 SD Recording out Video and YC output jack.
- 77 DC INPUT 12V 3.0A.

7. OPERATION

7.1 Basic Operation

Turn the power switch at the rear panel to the ON Position. The LEDs on the operation panel will light up and the unit is now in initial mode for operation.

7.2 Input Signal Selection and Back Color Selection

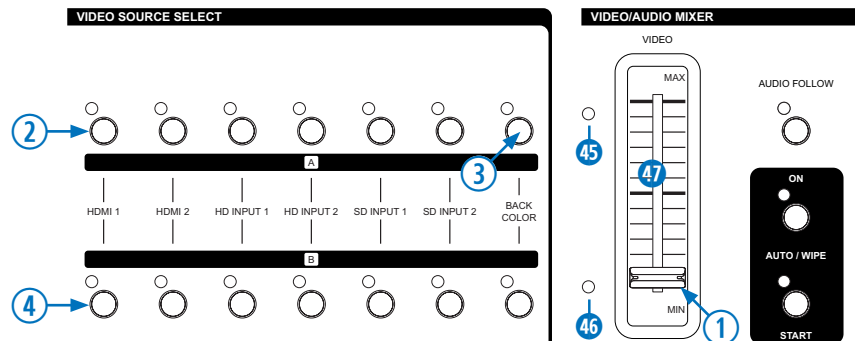

- ① → Move the Video slider (Button 47) to the A-bus position. The A-bus LED 45 will turn on, B-bus LED 46 will turn off.
- ② → Select your source for A-bus from any of the Sources (HDMI 1, HDMI 2, HD Input 1, HD Input 2, SD Input 1 or SD Input 2) and Back color button. You will see the corresponding picture on the screen.
- ③ → Press a Back Color button to select the background color required. Repeatedly pressing the Back Color selection button 37 will cycle through the available background colors (Blue, Red, Magenta, Green, Cyan, Yellow, White or Black).
- ④ → The same procedures apply to the B-bus.

NOTE: When the selected source input is not connected or has HDCP protection, only a blank, blue screen will be displayed.

7.3 Video Mix

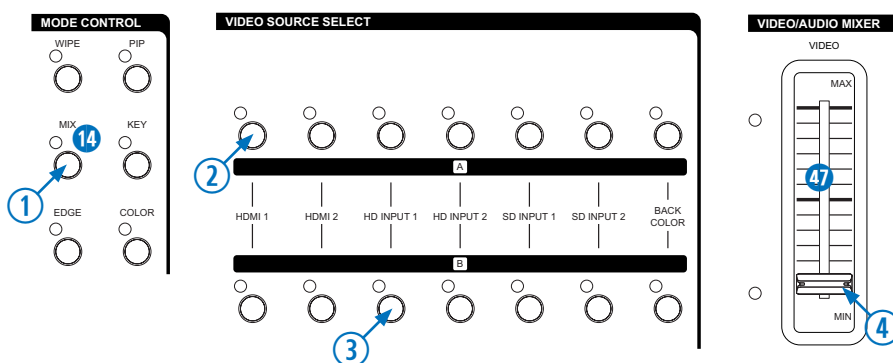

Reset the operation panel to initial mode:

- ① → Press the MIX button 14 to put the unit into mix mode
- ② → Press one of the A-bus selection buttons to select a source.
- ③ → Press one of the B-bus selection buttons to select a source.
- ④ → The Mix effect can be controlled by the Video slider 47 by moving it from A to B or B to A.

7.4 Video Wipe

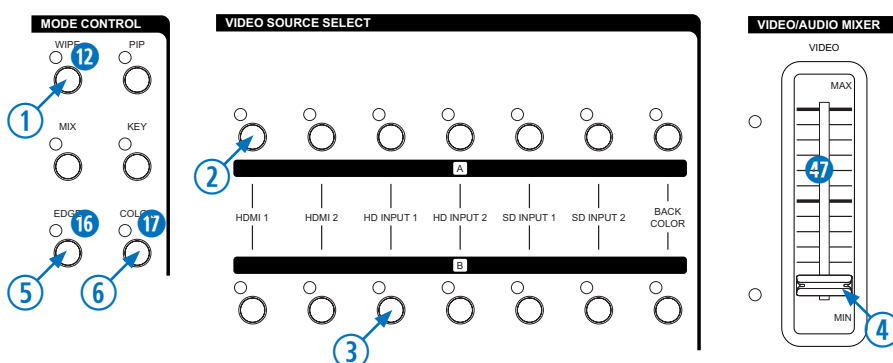

Reset the operation panel to initial mode:

- ① → Press the WIPE button 12.
- ② → Press one of the A-bus selection buttons to select a source.
- ③ → Press one of the B-bus selection buttons to select a source.
- ④ → The WIPE effect can be controlled by the Video Slider 47 by moving it from A to B or B to A, horizontally or vertically depending on the type of wipe used.
- ⑤ → Press EDGE button 16 to select sharp/soft/colored wipe edge.
- ⑥ → When the colored edge option for the wipe is selected, press COLOR button 17 to select one of the eight colors available.

7.5 WIPE PATTERN Selection

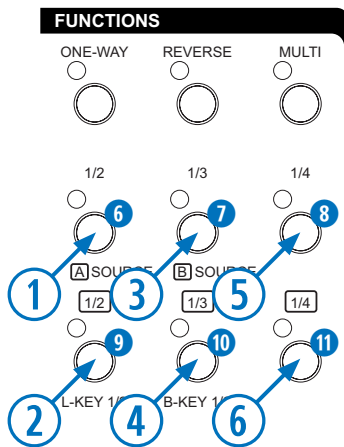

There are Six wipe modes available can be selected as follows:

- ① → Press the straight wipe button **6** repeatedly to toggle through the available wipe patterns. Four are available: Left to right, right to left, top to bottom and bottom to top

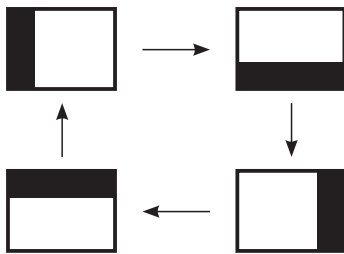

- ② → Press the corner wipe button **7** repeatedly to toggle through the available wipe patterns. Four are available: Top right to bottom left, bottom right to top left, bottom left to top right and top left to bottom right.

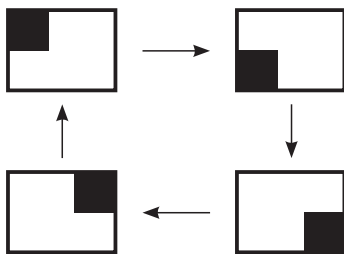

- ③ → Press the diagonal wipe button **8** repeatedly to toggle through the available wipe patterns. Four are available: Top right to bottom left, bottom right to top left, bottom left to top right and top left to bottom right.

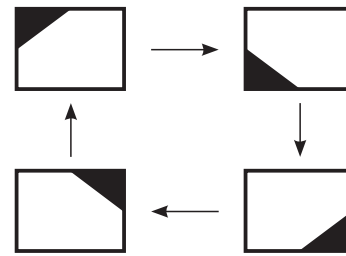

- ④ → Press the triangle wipe button **9** repeatedly to toggle through the available wipe patterns. Four are available: Left to right, Bottom to top, top and bottom simultaneously and left and right simultaneously.

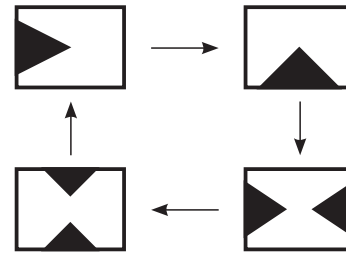

- ⑤ → Press the split wipe button **10** repeatedly to toggle through the available wipe patterns. Four are available: Left and right simultaneously, top and bottom simultaneously, all four corners simultaneously and rectangles from left and right simultaneously.

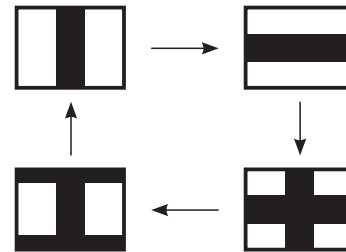

- ⑥ → Press the 'Shape' wipe button **11** repeatedly to toggle through the available wipe patterns. Four are available: Circle, oval, diamond and rectangle. The position of each wipe pattern in this section can be set via the Joystick Control **2**.

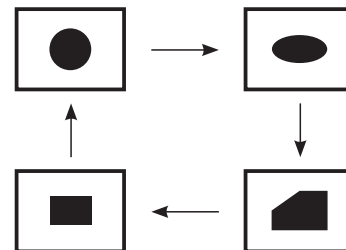

7.6 Multiple Pattern Selection

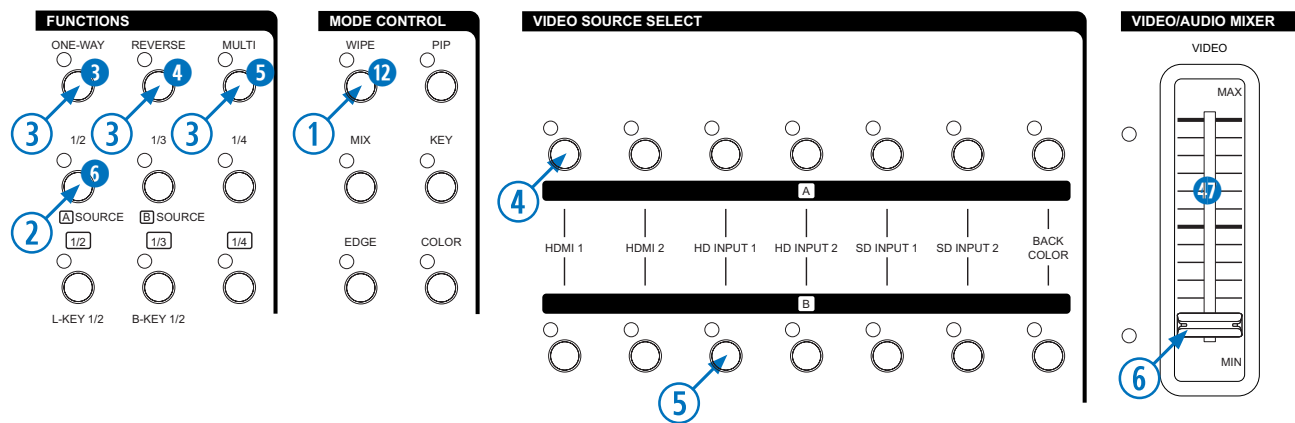

- ① → Press the WIPE button ⑫ to place the unit in WIPE mode.
- ② → Select a wipe pattern e.g. straight wipe by pressing button ⑥.
- ③ → Press the MULTI button ⑤ repeatedly to have the desired multiplication effect. Four options are available: x1, x2, x4 and x8
- ④ → Press one of the A-bus selection buttons to select a source.
- ⑤ → Press one of the B-bus selection buttons to select a source.
- ⑥ → Use the Video Slider ④⑦ to control the wipe pattern.

*The same procedure applies to the other wipe patterns.

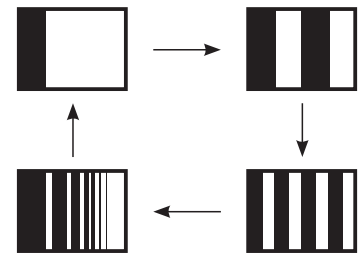

7.7 ONE-WAY WIPE

- ① → Press the WIPE button ⑫ to place the unit in WIPE mode.
- ② → Select a wipe pattern e.g. straight wipe by pressing button ⑥.
- ③ → Press the ONE-WAY ③ button.
- ④ → Press one of the A-bus selection buttons to select a source.
- ⑤ → Press one of the B-bus selection buttons to select a source.
- ⑥ → Use the Video Slider ④⑦ to control the wipe pattern.

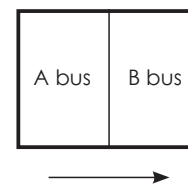

*The wipe pattern moves in the normal direction the Video Slider control ④⑦ is operated.

7.8 REVERSE WIPE

- ① → Press the WIPE button ⑫ to place the unit in WIPE mode.
- ② → Select a wipe pattern e.g. straight wipe by pressing button ⑥.
- ③ → Press the REVERSE ④ button.
- ④ → Press one of the A-bus selection buttons to select a source.
- ⑤ → Press one of the B-bus selection buttons to select a source.
- ⑥ → Use the Video Slider ④⑦ to control the wipe pattern.

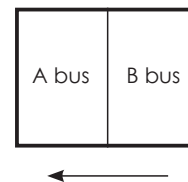

*The direction of the wipe pattern is reversed when the Video Slider control ④⑦ is operated.

7.9 Picture-In-Picture

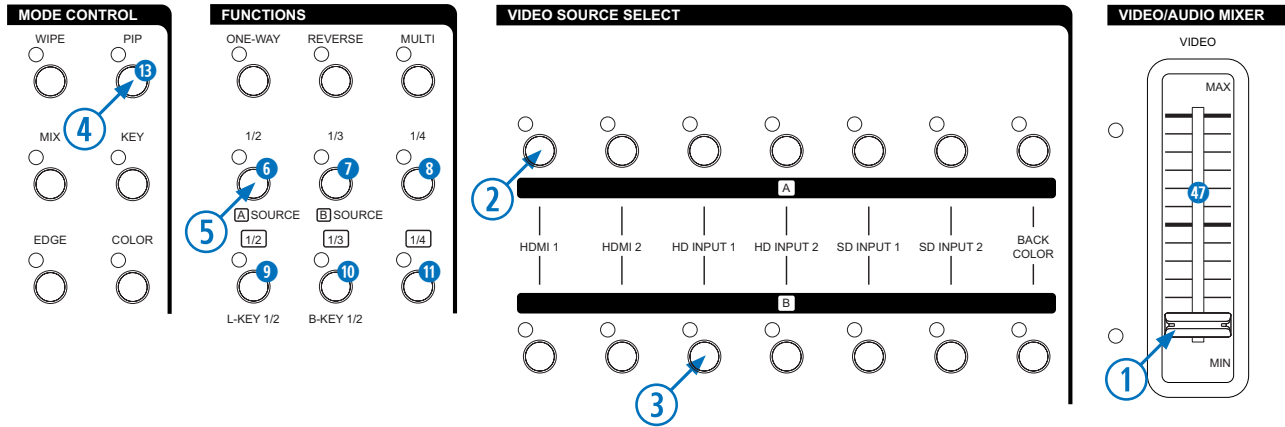

Press the operation panel to initial mode:

- ① → Move the Video Slider ④⑦ fully to the B-bus position.
- ② → Press one of the A-bus selection buttons to select a source.
- ③ → Press one of the B-bus selection buttons to select a source.
- ④ → Press the PIP button ⑬ to put the unit into picture-in-picture mode.
- ⑤ → The PIP mode can be selected by pressing ⑥ ~ ⑪ buttons:
 - ⑥ Shows the picture-in-picture box at $\frac{1}{2}$ size without the frame edge.
 - ⑦ Shows the picture-in-picture box at $\frac{1}{3}$ size without the frame edge.
 - ⑧ Shows the picture-in-picture box at $\frac{1}{4}$ size without the frame edge.
 - ⑨ Shows the picture-in-picture box at $\frac{1}{2}$ size with the frame edge.
 - ⑩ Shows the picture-in-picture box at $\frac{1}{3}$ size with the frame edge.
 - ⑪ Shows the picture-in-picture box at $\frac{1}{4}$ size with the frame edge.

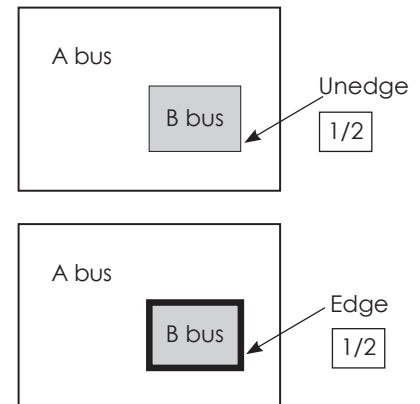

NOTE:

- The color of the frame edge can be changed by using the back color select button ⑰.
- When you move the Video Slider ④⑦ to the A-bus position PIP picture dissolves into background scene.
- The position of the PIP frame can be controlled by the Joystick Control ②.

7.10 KEY

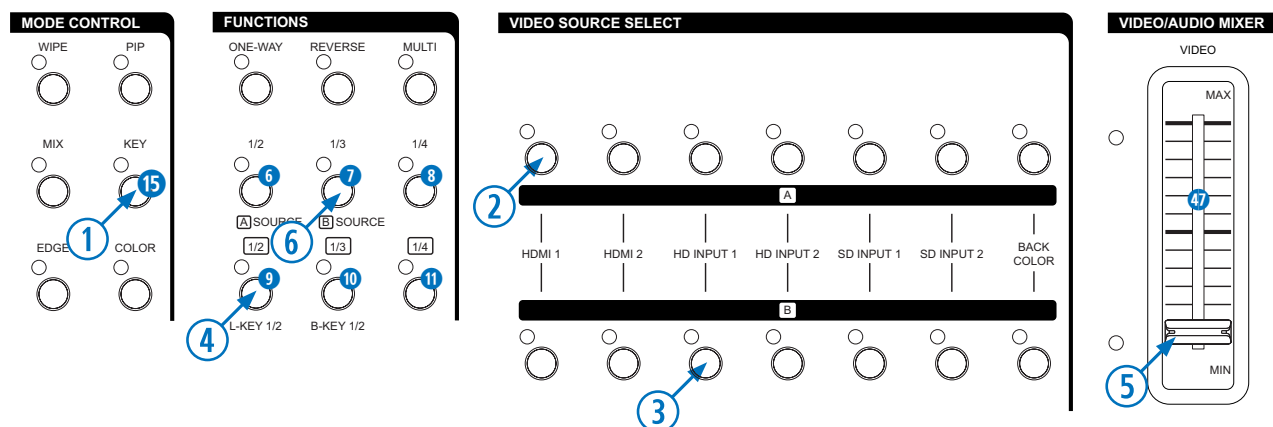

Reset the operation panel to initial mode:

How to use the LUMA KEY effect:

- ① → Press the KEY button 15 to place the unit in KEY mode.
- ② → Press one of the A-bus selection buttons to select a source.
- ③ → Press one of the B-bus selection buttons to select a source.
- ④ → Press the LUMA KEY button 9. The darker areas of the picture will become transparent and allow the image of the other source to show through.
- ⑤ → Use the Video Slider 47 to control the Luma key level.
- ⑥ → Press button 6 or 7 to change the source that is being keyed.
- ⑦ → Press the LUMA KEY 9 again to reverse the Luma Key effect.

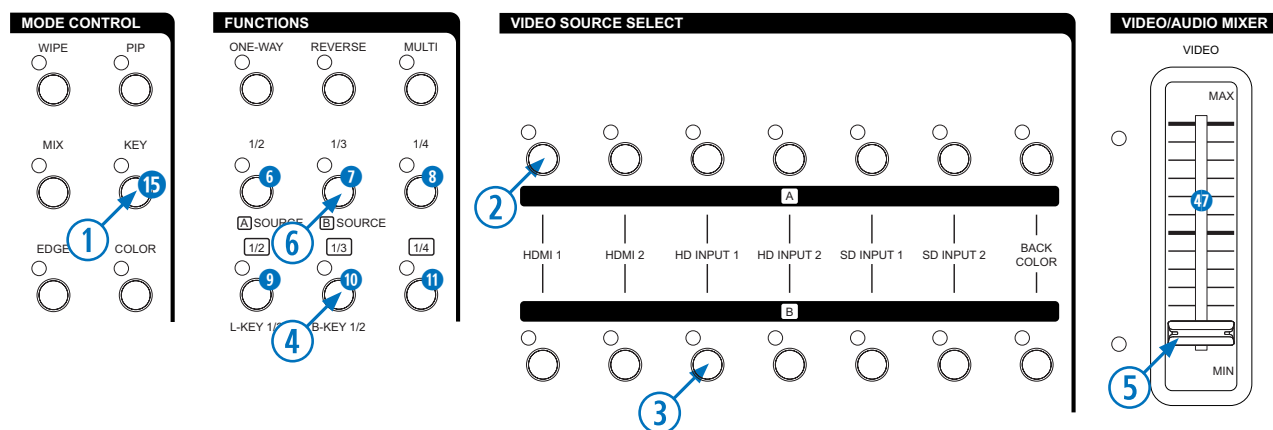

How to use the BLUE KEY effect:

- ① → Press the KEY button 15 to place the unit in KEY mode.
- ② → Press one of the A-bus selection buttons to select a source.
- ③ → Press one of the B-bus selection buttons to select a source.
- ④ → Press the BLUE KEY button 10. The blue areas of the picture will become transparent and allow the image of the other source to show through.
- ⑤ → Use the Video Slider 47 to control the LUMA KEY level.
- ⑥ → Press button 6 or 7 to change the source that is being keyed.
- ⑦ → Press the Blue KEY 10 again to reverse the BLUE KEY effect.

7.11 AUTO FADE/WIPE Selection

Reset the operation panel to initial mode:

- ① → Press the ON button 49 to enter AUTO FADE/WIPE mode.
- ② → FADE/WIPE transition time can be adjusted with the TIME control 1.
- ③ → Press the WIPE button 12 to select the wipe effect.
- ④ → Press the MIX button 14 to select MIX (FADE) effect.
- ⑤ → Press the START button 50 to start Auto wipe or fade effect.

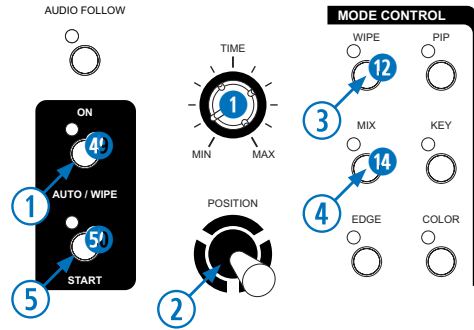

NOTE: When in AUTO FADE/WIPE mode the Video Slider 47 is disabled.

7.12 DIGITAL EFFECT

Digital effect section which generates special effects for the A bus and B-bus source video signals. The selected effect(s) can be added to either the A-bus or B-bus or both simultaneously. Effects can also be combined e.g. MOSAIC and NEGATIVE can be combined to make a negative mosaic image.

NOTE: The mosaic effect is not available in the picture-in-picture frame in PIP mode.

- 18 / 23 A-bus, B-bus digital effect ON button.
- 19 / 24 STILL button - creates a still frame.
- 20 / 25 PAINT button - creates a 'paint' effect. Repeatedly pressing the PAINT button will cycle through 3 levels of the effect.
- 21 / 26 NEGATIVE button - creates a negative image.
- 22 / 27 MOSAIC button - creates a 'pixellated' effect. Repeatedly pressing the MOSAIC button will cycle through 3 levels of the effect.

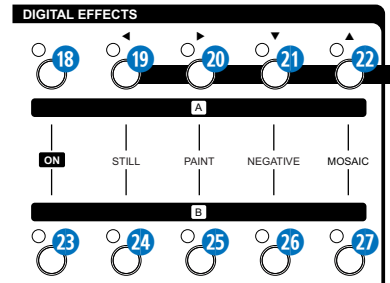

7.13 AUDIO MIXER

The Audio can be controlled either separately or in combination with a video source.

- 48 In AUDIO FOLLOW mode the audio will be controlled with the Video Slider 47 as well as the video. When the LED is off the Audio will be adjusted by 51 and 52 buttons.
- 51 Adjusts the A-bus source's audio level.
- 52 Adjusts the B-bus source's audio level.
- 53 AUX: Controls the audio level of the auxiliary input.
- 54 MIC: Controls the audio level of the microphone input.

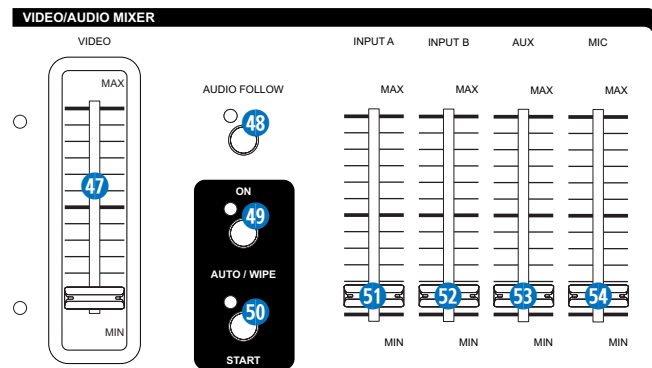

7.14 OSD ADJUST

- 28 Connecting a display via the SD PREVIEW output will allow access to the on-screen display. When not in OSD ADJUST mode the output will show A/B-bus and output system information.

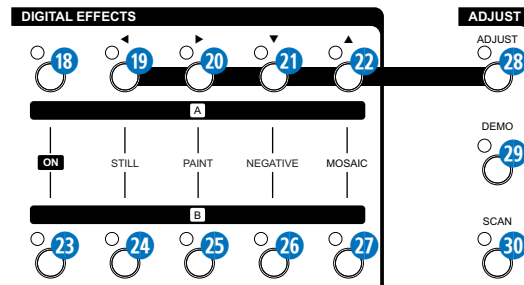
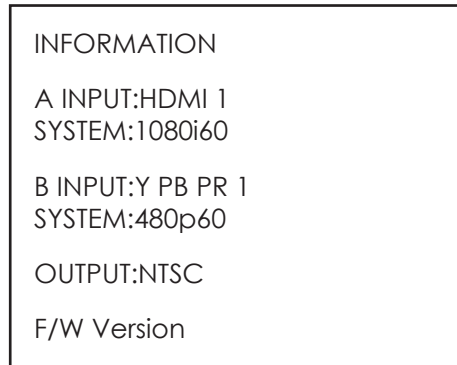

- 28 When in OSD ADJUST mode, output will show the setup adjustment menu screen as shown below.

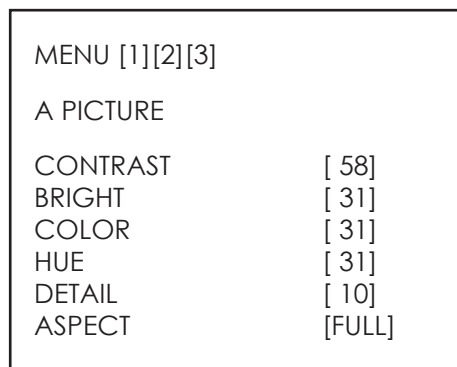

When in MENU mode, press 19 ◀ 20 ▶ to adjust the page. Press 21 ▼ and 22 ▲ to select the functions; once the functions are selected press 19 ◀ and 20 ▶ to adjust the values.

NOTE: The values are not saved to the unit's memory until you exit the OSD ADJUST mode. When the unit is turned off the system will change the value back to its default value. Press ADJUST 28 to exit the OSD adjust screen and the system will automatically save to the memory.

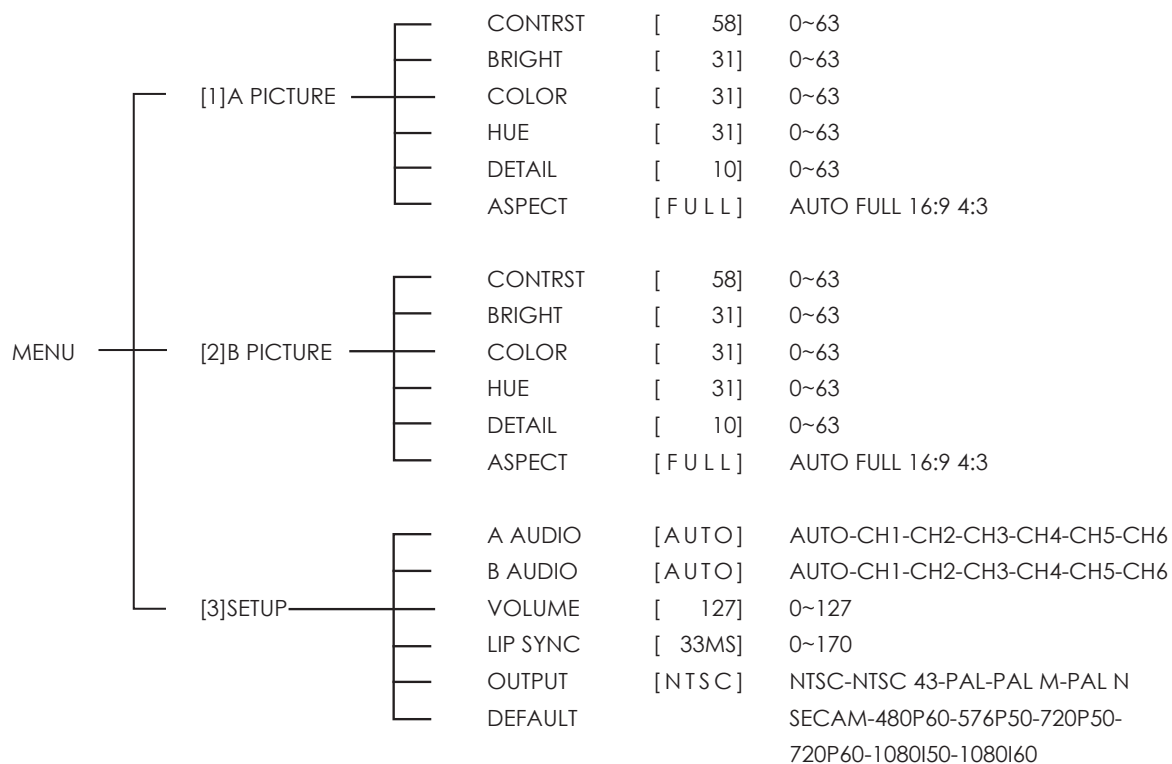

8. CONNECTOR AND INSTALLATION

8.1 Front Panel Connections

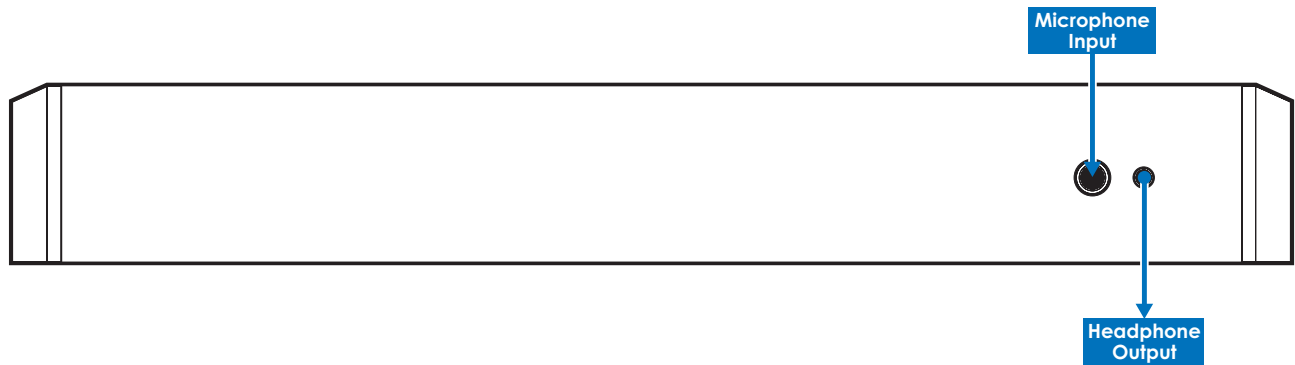

8.2 Rear Panel Connections

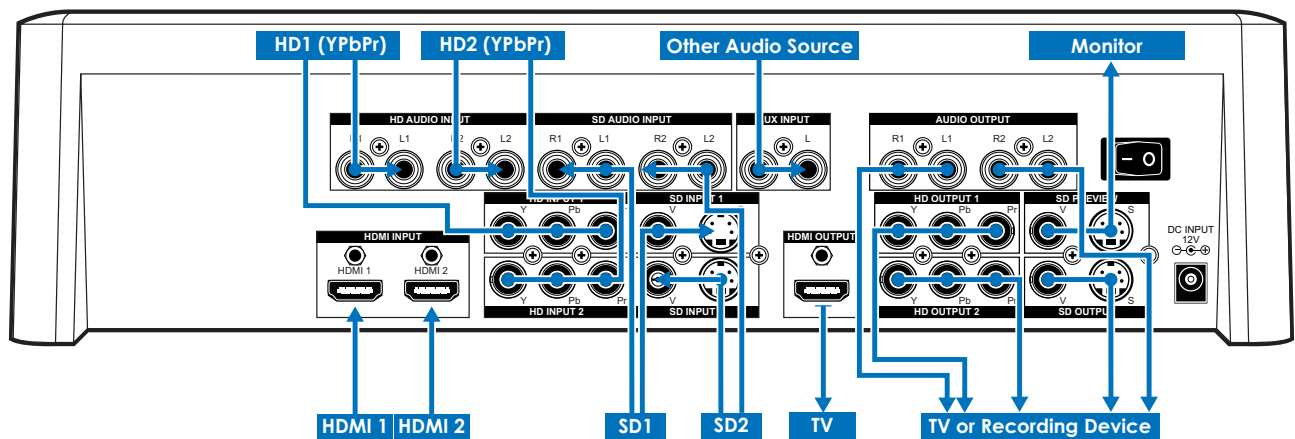

8.3 Output Resolutions

The output resolution/system can set via the on-screen display on the SD PREVIEW output to adjust the output system or the output can be set by pressing a combination of two keys for 1 second.

The combinations below:

- 50 button + 31 button = 480p60
- 50 button + 32 button = 576p60
- 50 button + 33 button = 720p50
- 50 button + 34 button = 720p60
- 50 button + 35 button = 1080i50
- 50 button + 36 button = 1080i60
- 50 button + 37 button = NTSC
- 50 button + 38 button = NTSC 43
- 50 button + 39 button = PAL
- 50 button + 40 button = PAL M
- 50 button + 41 button = PAL N
- 50 button + 42 button = SECAM50

9. SPECIFICATIONS

SOURCE INPUT	<p>6 (SOURCE 1/6) HDMI Input x 2 Digital Video YUV(480i/p,576i/p,720p50/60,1080i50/60, 1080p50/60). Component Input x 2 Analog Video YUV(480i/p,576i/p,720p50/60,1080i50/60). Y/C input x 2 Y signal: 1.0 Vp-p 75Ω, Mini Din 4-pin connector C signal: 0.3 Vp-p 75Ω, Mini Din 4-pin connector Video input x 2 1.0 Vp-p 75Ω composite signal, Pin-Jack (NTSC,NTSC4.43,PAL,PAL-M,PAL-N,SECAM) Audio input x 4 -6 dBs/20 kΩ Pin Jack (L/R).</p>
EXTERNAL SOUND INPUT	<p>MIC input x 1 (MIC); -60 dBv/600Ω AUX input x 1 (AUX); -6 dBs/20 kΩ, Pin Jacks(L/R)</p>
RECORDING OUTPUT	<p>HDMI Output x 1 Digital Video YUV(480i/p,576i/p,720p50/60,1080i50/60). Component Output x 2 Analog Video YUV(480i/p,576i/p,720p50/60,1080i50/60). Y/C Output x 1 Y signal: 1.0 Vp-p 75Ω, Mini Din 4-pin connector C signal: 0.3 Vp-p 75Ω, Mini Din 4-pin connector Video Output x 1 1.0 Vp-p 75Ω composite signal, Pin-Jack (NTSC,NTSC4.43,PAL,PAL-M,PAL-N,SECAM) Audio Output x 2 -6 dBs/20 kΩ Pin Jack (L/R).</p>
PREVIEW OUTPUT(OSD)	<p>Y/C Output x 1 Y signal: 1.0 Vp-p 75Ω, Mini Din 4-pin connector C signal: 0.3 Vp-p 75Ω, Mini Din 4-pin connector Video Output x 1 1.0 Vp-p 75Ω composite signal, Pin-Jack (NTSC,NTSC4.43,PAL,PAL-M,PAL-N,SECAM)</p>
HEADPHONE OUTPUT	<p>Headphone x 1; -20 dBv~ -80 dBv, 8Ω unbalanced, phone-5 jack</p>
EFFECTS	<p>Video: Still, Mosaic, Paint, Negative, Wipe, Mix, Fade, Picture-In-Picture, Chroma key, Luminance key</p>
BACK COLOR	<p>8 (White, Yellow, Cyan, Green, Magenta, Red, Blue, Black)</p>
WIPE PATTERNS	<p>96 patterns</p>
S/N (TYPICAL)	<p>Video: 48 dB (composite), 50 dB (HDMI,Component,Y/C) Audio: 60 dB</p>
POWER SOURCE	<p>12V DC 3A</p>
POWER CONSUMPTION	<p>Approx. 15W</p>
DIMENSIONS	<p>267(W) x 370(D) x 103.5(H) mm</p>
WEIGHT	<p>2 Kgs</p>

