



CPLUS-662CVEA

6×8 HDMI and HDBaseT Matrix
with Audio Matrixing & LAN Serving



Operation Manual

DISCLAIMERS

The information in this manual has been carefully checked and is believed to be accurate. Cypress Technology assumes no responsibility for any infringements of patents or other rights of third parties which may result from its use.

Cypress Technology assumes no responsibility for any inaccuracies that may be contained in this document. Cypress also makes no commitment to update or to keep current the information contained in this document.

Cypress Technology reserves the right to make improvements to this document and/or product at any time and without notice.

COPYRIGHT NOTICE

No part of this document may be reproduced, transmitted, transcribed, stored in a retrieval system, or any of its part translated into any language or computer file, in any form or by any means—electronic, mechanical, magnetic, optical, chemical, manual, or otherwise—without express written permission and consent from Cypress Technology.

© Copyright 2017 by Cypress Technology.

All Rights Reserved.

TRADEMARK ACKNOWLEDGMENTS

All products or service names mentioned in this document may be trademarks of the companies with which they are associated.





SAFETY PRECAUTIONS

Please read all instructions before attempting to unpack, install or operate this equipment and before connecting the power supply.

Please keep the following in mind as you unpack and install this equipment:

- Always follow basic safety precautions to reduce the risk of fire, electrical shock and injury to persons.
- To prevent fire or shock hazard, do not expose the unit to rain, moisture or install this product near water.
- Never spill liquid of any kind on or into this product.
- Never push an object of any kind into this product through any openings or empty slots in the unit, as you may damage parts inside the unit.
- Do not attach the power supply cabling to building surfaces.
- Use only the supplied power supply unit (PSU). Do not use the PSU if it is damaged.
- Do not allow anything to rest on the power cabling or allow any weight to be placed upon it or any person walk on it.
- To protect the unit from overheating, do not block any vents or openings in the unit housing that provide ventilation and allow for sufficient space for air to circulate around the unit.

REVISION HISTORY

VERSION NO.	DATE (DD/MM/YY)	SUMMARY OF CHANGE
RDV1	14/01/17	Draft
RDV2	10/03/17	Updated text/diagrams
RDV3	14/03/17	Corrections to section 8.1
RDV4	20/03/17	Corrections to section 6.8.3
RDV5	18/04/17	Corrections to section 6.4



CONTENTS

1. Introduction	1
2. Applications	1
3. Package Contents	2
4. System Requirements	2
5. Features	2
6. Operation Controls and Functions	4
6.1 Front Panel	4
6.2 Rear Panel	5
6.3 Side Panel	8
6.4 Remote Control	9
6.5 OLED Menu	10
6.6 IR Cable Pin Assignment	11
6.7 RS-232 Protocol	11
6.8 RS-232 and Telnet Commands	12
6.8.1 Command Syntax	12
6.8.2 Real World Command Use	14
6.8.3 Full Command List	17
6.9 Telnet Control	32
6.10 WebGUI Control	34
6.10.1 Video Switch	36
6.10.2 Zone Audio	41
6.10.3 Extended Audio	43
6.10.4 HDMI Audio	44
6.10.5 HDBaseT Audio	45
6.10.6 Zone A/V Pairing	47
6.10.7 EDID Settings	48
6.10.8 HDBaseT & H/W Info	50
6.10.9 User Config	51
6.10.10 System Settings	51
6.10.11 Logout	52



7. Connection Diagram	53
8. Specifications	54
8.1 Technical Specifications	54
8.2 Video Specifications	55
8.2.1 Supported HDMI Resolutions	55
8.2.2 Maximum HDMI Cable Length	56
8.3 Audio Specifications	56
8.3.1 Analog Audio	56
8.3.2 Linear PCM Audio	57
8.3.3 Compressed Audio	57
8.3.4 Audio Adjustments	57
8.4 Category Cable Specifications	58
8.5 HDBaseT Features	58
9. Acronyms	59



1. INTRODUCTION

This 6×8 HDMI and HDBaseT Matrix supports routing and transmission of video (resolutions up to 4K@60Hz w/ HDMI 2.0 & HDCP 2.2) and audio (multi-channel digital/stereo analog) while providing flexible control via IR, RS-232, Telnet or WebGUI. As many as six UltraHD sources may be routed to any of eight destinations, six via single Cat.5e/6/7 cables (up to 100m at 1080p or up to 60m at 4K@30Hz) and two via HDMI 2.0 outputs. The two HDMI 2.0 outputs support transmission of 18Gbps UltraHD HDMI sources (up to 4K@60Hz, 4:4:4) from any HDMI input or they can mirror any of the HDBaseT outputs for local monitoring. 3D video is also supported when compatible sources and displays are connected.

This product supports passing 7.1 channel LPCM digital audio as well as advanced bitstream and HD bitstream audio formats. Additionally, six analog audio outputs are available to provide stereo breakout audio from the associated HDBaseT output (LPCM 2.0 sources only). Beyond basic video routing, this product also incorporates an independent audio matrix with eight audio outputs and four audio inputs. Offering discrete audio routing, insertion and extraction, this product makes it possible to have multiple audio zones within your installation. This product supports the Optical Audio Return (OAR) channel feature, found on compatible HDBaseT receivers, allowing optical audio sources connected to those receivers to be sent back to the matrix unit.

LAN support allows your 100BaseT network to be extended to smart TVs or game consoles. Internally generated test patterns (up to 18Gbps UHD resolutions) are provided to assist with setup, providing a simple way to verify both matrix and sink functionality. The Power over HDBaseT (PoH) function can power compatible receivers, providing greater flexibility in your installations. Control is via manual selection buttons, WebGUI, Telnet, RS-232 or IR remote.

2. APPLICATIONS

- Full audio/video matrix systems
- Residential AV matrix installations
- Commercial AV matrix installations
- Security systems



- University lecture hall systems
- Retail installation systems

3. PACKAGE CONTENTS

- 1× 6 by 8 HDMI and HDBaseT Matrix with Audio Matrixing
- 1× Remote Control (CR-163)
- 2× IR Extender Cable
- 2× IR Blaster Cable
- 2× 24V/6.25A DC Power Adaptor
- 2× Power Cord
- 1× Rack Ear Set
- 1× Operation Manual

4. SYSTEM REQUIREMENTS

- HDMI or DVI source equipment such as media players, video game consoles, set-top boxes, PCs or laptops. DVI equipped source devices must be connected via DVI to HDMI cables/adapters
- HDMI receiving equipment such as HDTVs, monitors or audio amplifiers
- The use of industry standard Cat.6, Cat.6a or Cat.7 cable is highly recommended
- HDBaseT™ receivers equipped with Optical Audio Return (OAR) channel support are strongly recommended
- The use of "Premium High Speed HDMI" cables is highly recommended

5. FEATURES

- HDMI 2.0, HDCP 1.4 and HDCP 2.2 compliant
- Routes 6 HDMI sources to 8 displays using 6 HDBaseT outputs and 2 independent or mirrored HDMI outputs
- HDBaseT 5-Play™ convergence: High-Definition video and audio, 100BaseT Ethernet, 48v PoH (Power over HDBaseT) and control (Bi-directional IR & RS-232 pass through)

- Supported HDBaseT resolutions: VGA~WUXGA, 480i~1080p, 4K@24/25/30Hz (RGB, YUV 4:4:4 & YUV 4:2:2) & 4K@60Hz (YUV 4:2:0) dependent upon the output display's EDID settings
- Supports HDMI output resolutions up to 4K@60Hz (RGB/YUV 4:4:4)
- Supports automatic 4K@60Hz RGB/YUV 4:4:4 to YUV 4:2:0 conversion for HDBaseT outputs
- 4K@30Hz signals can be transmitted up to 60m via Cat.5e/6 and up to 100m via Cat.6a/7
- Supports pass-through of all standard digital audio formats: LPCM 2.0/5.1/7.1, bitstream, and HD bitstream
- Supports audio matrix functionality enabling full audio management of the system including HDBaseT audio selection, fully independent audio-only zones and HDMI audio embedding and de-embedding (LPCM only)
- Supports Digital to Analog Conversion (DAC) and Analog to Digital Conversion (ADC) for audio integration
- Supports volume, treble, bass, and audio delay for lip-sync (up to 230ms) on analog audio outputs and mute on all outputs
- HDBaseT outputs with Optical Audio Return (OAR) support
- Advanced internal and external EDID management with 4 sets of configurable EDID settings
- Internal test pattern generation for self and sink testing
- Capable of generating test signals up to 4K@60Hz
- Bi-directional IR support over HDBaseT
- Control via front panel controls, Ethernet (Telnet & WebGUI), RS-232, & IR remote
- 2U rack mounted design

6. OPERATION CONTROLS AND FUNCTIONS

6.1 Front Panel

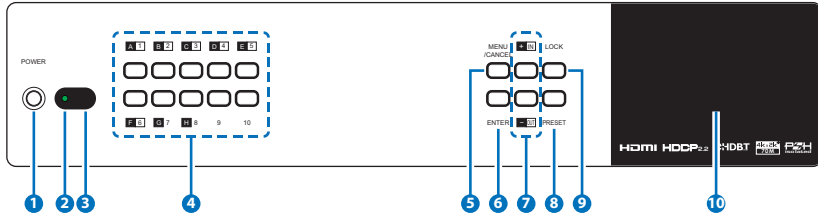

- 1 POWER:** Press this button to power the unit on or place it into stand-by mode.

Note: Network functionality and PoH (if the second power supply is connected) remain active when the unit is in stand-by mode.

- 2 POWER LED:** This LED will illuminate GREEN to indicate the unit is on and receiving power. When the unit is in stand-by mode the LED will illuminate RED.

- 3 IR WINDOW:** Accepts IR signals from the included IR remote for control of this unit only.

- 4 OUTPUT A~H & INPUT/NUMBER 1~6:** Press the “OUT” button to enter output selection mode. Next, press the output keys (A~H) of the outputs you wish to route a source to (they will flash to indicate selection). Next, press the “IN” key followed by the input (1~6) you wish to route to the selected outputs. Finally, press “ENTER” to confirm your selection and execute the routing change.

For example, if you wish to display input 1 on outputs A~D then the following sequence of button presses should be performed: OUT → A, B, C, D → IN → 1 → ENTER

When directly entering Ethernet address information into the unit all 10 buttons are used to represent the numbers from 0 to 9 (button 10 = 0) to make number entry more streamlined.

- 5 MENU/CANCEL:** Press the “MENU/CANCEL” button to enter the OLED menu, or to back out from menu items. For a description of the menu tree, please refer to section 6.5.

- 6 ENTER:** Press this button to confirm selections.

- 7 +/IN:** Within the menu, this button moves you up within the menu tree. Otherwise, in routing mode, this button allows you to make your input source selection.
-/OUT: Within the menu, this button moves you down within the menu tree. Otherwise, this button starts routing mode and allows you to begin your output destination selections.
- 8 PRESET:** Press this button to recall saved presets. A maximum of 8 presets can be stored in the unit. Presets are created and stored via the WebGUI. Please refer to section 6.10.1 for advanced preset settings.
- 9 LOCK:** Press and hold this button for 3 seconds to lock/unlock all buttons on the front panel. The OLED will display an “L” in the upper right corner to indicate the front panel is locked.
- 10 OLED WINDOW:** Displays the unit’s menu, settings and information.

6.2 Rear Panel

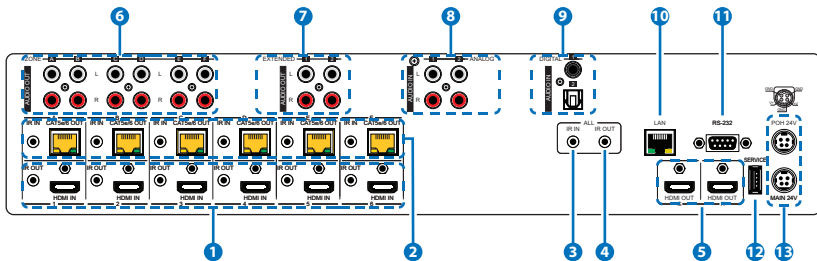

- 1 HDMI IN & IR OUT 1~6:** Connect up to 6 source devices to the HDMI ports using appropriate quality HDMI cables. Input source devices include Blu-ray players, set-top boxes, game systems and so on. These inputs are DVI-D compliant (with the use of DVI to HDMI adapters or cables). Attach IR blasters to the IR Out ports to transmit the IR signals received from connected HDBaseT Receivers. The IR signal routing follows the HDMI signal routing.
Note: The use of “Premium High Speed HDMI” cables is highly recommended.
- 2 CAT5e/6 OUT & IR IN A~F:** Connect the Cat.5e/6 outputs via an appropriate cable to the input ports of compatible HDBaseT receivers for HDMI audio/video and IR/RS-232 control signal



transmission. In order for an IR signal to be transmitted along with the HDMI signal an IR extender must be connected to the associated IR In port. IR signals coming back from the connected HDBaseT receiver can be used to control the matrix remotely and will also be broadcast from IR blasters connected to the appropriate IR Out/All IR Out ports.

Note: 4K signals with HDR (High Dynamic Range) or Deep Color are supported by the 2 HDMI output ports, however they are not supported by the HDBaseT outputs due to bandwidth limitations. If your HDR source needs to be output over the HDBaseT outputs please remember to disable the HDR support on your source device or use a non-HDR supporting EDID.

3 IR IN (ALL): Connect an IR extender to this port for IR signal reception. All IR signals received will be broadcast by all IR blasters connected to the matrix or connected HDBaseT receivers. Please ensure that the remote being used is within direct line-of-sight of the IR extender.

4 IR OUT (ALL): Connect an IR Blaster to this port to broadcast IR signals. All IR signals received by any IR extenders connected to the matrix or HDBaseT receivers will be broadcast. Please place the IR Blaster in direct line-of-sight of the equipment to be controlled.

5 HDMI OUT G & H: Connect up to 2 HDMI displays using these HDMI output ports. These two HDMI ports can be either independent high bandwidth (18Gbps) outputs, or they can be configured to mirror two of the HDBaseT outputs for local monitoring or recording purposes.

Note: 4K signals with HDR (High Dynamic Range) or Deep Color are supported by the 2 HDMI output ports, however they are not supported by the HDBaseT outputs due to bandwidth limitations. If your HDR source needs to be output over the HDBaseT outputs please remember to disable the HDR support on your source device or use a non-HDR supporting EDID.

6 ZONE AUDIO OUT A~F: Six sets of stereo analog audio outputs. These audio ports are capable of independently outputting audio routed from any audio source within the matrix. Treble, bass, volume and audio delay adjustments can be set in the WebGUI (LPCM 2.0 or analog stereo sources only).

7 EXTENDED AUDIO OUT 1~2: Two sets of stereo analog audio outputs.

These audio ports are capable of independently outputting audio routed from any audio source within the matrix. Treble, bass, volume and audio delay adjustments can be set in the WebGUI (LPCM 2.0 or analog stereo sources only).

- 8 ANALOG AUDIO IN 1~2:** Accepts unbalanced analog audio from sources such as DVD players, PCs, MP3 players, etc. These audio sources can be paired with the video from any HDMI input.
- 9 DIGITAL AUDIO IN 1~2:** Accepts digital audio (LPCM 2.0 only) from sources such as Blu-ray players, game systems, PCs, etc. These audio sources can be paired with the video from any HDMI input.
- 11 LAN:** Connect to an active Ethernet network to allow for Telnet and WebGUI control of the matrix (refer to sections 6.9 and 6.10) as well as to share the network (including Internet, if available) with connected compatible LAN equipped HDBaseT receivers. This allows for any Ethernet equipped device (e.g. a smart TV or game console) connected to the LAN port of a receiver to share the network/Internet access.
- 12 RS-232:** Connect directly to your PC/laptop to send RS-232 commands to control the unit (refer to section 6.7).
- 13 SERVICE:** Used for firmware service updates in the field via USB thumb drive. After connecting a USB thumb drive containing appropriate firmware, please navigate via the front panel menu to 5-Firmware → 2-Update → YES to begin the firmware update.
- 14 MAIN 24V & POH 24V:** Plug one of the 24V power supplies (included in the package) into the port marked "MAIN 24V" to power the matrix unit. If you wish to connect PoH powered HDBaseT receivers to the matrix, please plug the second 24V power supply into the "POH 24V" port. This will allow the matrix to provide 48v PoH to all connected HDBaseT receivers.

6.3 Side Panel

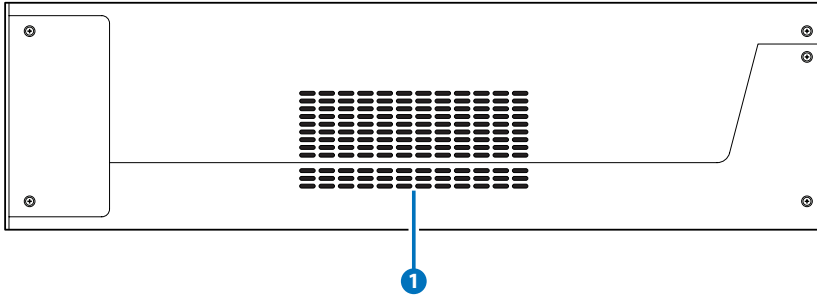

- 1 FAN VENT:** These are air ventilation areas. DO NOT block these areas or cover them with any objects. Please allow adequate space around the unit for air circulation.

6.4 Remote Control

- 1 **POWER:** Press to power the unit on or place it into stand-by mode.
- 2 **LOCK:** Press to lock/unlock the front panel of the matrix unit.
- 3 **MUTE:** Mutes Zone Audio outputs. HDBaseT audio can only be muted when an independent, non-HDMI, audio source has been routed to the output.
- 4 **IN 1~6, OUT A~H & PATTERN:**

[Local matrix control]: When controlling the unit directly. Input selection from 1~6 plus test patterns (pattern button) and output selection from A~H (refer to section 6.1).

[Zone A/V Pairing]: When controlling the unit via an HDBaseT receiver in a remote location. Pressing buttons 1~6 will switch to the A/V source assigned to the number depending on your current zone. These assignments are configured via the WebGUI (refer to section 6.10.6).

- 5 **MENU/CANCEL:** Press the “MENU/CANCEL” button to enter the OLED menu, or to back out from menu items.
- 6 **PRESET:** Recall matrix presets. The presets are configured within the WebGUI.
- 7 **+/IN:** Within the menu, this button moves you up within the menu tree. Otherwise, in routing mode, this button allows you to make your input source selection.

-/OUT: Within the menu, this button moves you down within the menu tree. Otherwise, this button starts routing mode and allows you to begin your output destination selections.

◀/VOL- & ▶/VOL-: Adjust volume of zone audio.

ENTER: Press this button to confirm selections.

Note: This remote control is designed for the full family of matrix products. Some functions are not available on all units.

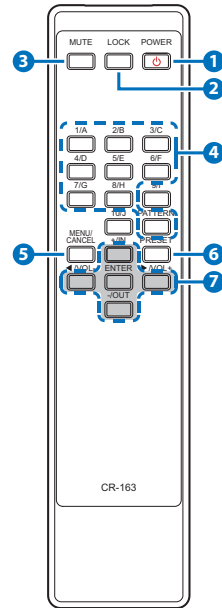

6.5 OLED Menu

1ST LEVEL	2ND LEVEL	3RD LEVEL
EDID	EDID Mode	All
		Independent
	EDID Select	All
		1~6 (Default EDID settings)
		7~14 (Sink's EDID settings)
	15~18 (User's EDID settings)	
Network	Link Status (Idle)	
	IP Address	
	Subnet Mask	
	Gateway Address	
	MAC Address	
	DHCP mode	On
	Off	
HDMI Mirroring	Output G	
	Output H	
Factory Default	Yes	
	No	
Firmware	Version	
	Update	Yes
		No

Note: The model name and IP address will be displayed when the unit is powered on. The netmask and gateway information can be displayed by repeatedly pressing the “+” button on the front panel or remote control unit.

6.6 IR Cable Pin Assignment

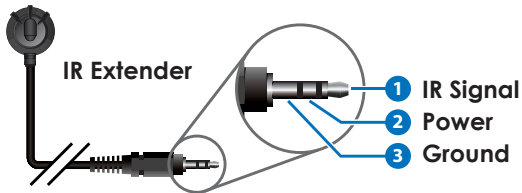
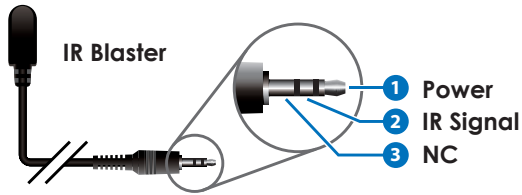

6.7 RS-232 Protocol

MATRIX	
Pin	Assignment
1	NC
2	TX
3	RX
4	NC
5	GND
6	NC
7	NC
8	NC
9	NC



REMOTE CONTROLLER	
Pin	Assignment
1	NC
2	RX
3	TX
4	NC
5	GND
6	NC
7	NC
8	NC
9	NC

Baud Rate: 115200bps
 Data Bits: 8
 Parity: None
 Flow Control: None
 Stop Bits: 1



6.8 RS-232 and Telnet Commands

6.8.1 Command Syntax

The RS-232/Telnet command structure for this unit is both flexible and powerful, and allows for multiple parameters to be set across multiple ports simultaneously within a single command transmission. This section will detail the command syntax used to send both simple (single port/single parameter) commands as well as the more complex (multi-port/parameter) commands.

The following multi-function syntax is specifically for use with these commands: "ZoneLineOut", "ExtLineOut", "HDMI_Out", "HDBT_Out", and "Pattern". "ZoneAvPair" has a special structure that will be explained separately. All other commands must be sent within discrete transmissions.

- **Basic Command Format**

Use this syntax to set or change a single parameter for a single input/output port.

<Command> {Port} {Parameter [= Value]}

Examples: ZoneLineOut B Treble= -12

HDBT_Out A Mute

- **Basic Command Format (ZoneAvPair)**

The ZoneAvPair command requires multiple variables to define the location of the slot's value to adjust. This command only accepts 3 possible parameters: "VideoSrc", "AudioSrc", and "Load". Use the following syntax to set or change a single parameter for a single slot assigned to an HDBaseT or HDMI output port.

ZoneAvPair HDBT_Out {Port} Slot {Slot} {Parameter [= Value]}

Examples: ZoneAvPair HDBT_Out B Slot 5 VideoSrc = HDMI_In 2

ZoneAvPair HDMI_Out H Slot 3 Load

- **Multi-Port Command Format**

Use the following syntax to set or change a single parameter for multiple ports. Note that each additional port uses the "+" character

for separation. The number of ports allowed in a single command is limited by the number of ports on that specific interface.

<Command> {Port1}+{Port2}+{Etc.} {Parameter [= Value]}

Examples: ZoneLineOut A+B+C Treble = -12

HDBT_Out A+D+F Mute

- **Multi-Slot Command Format (ZoneAvPair)**

The ZoneAvPair command allows for multiple slots on a single HDBaseT or HDMI output to be assigned the same value simultaneously. Use the following syntax to accomplish this. Note that each additional slot uses the “+” character for separation. The number of slots allowed in a single command is limited by the number of slots on that specific interface.

ZoneAvPair HDBT_Out {Port} Slot {Slot1}+{Slot2}+{Etc.} {Param [= Value]}

Example: ZoneAvPair HDBT_Out B Slot 1+3+5 VideoSrc = HDMI_In 2

- **Multi-Parameter Command Format**

Use the following syntax to set or change multiple parameters for a single port. Note that each additional parameter uses the “,” character for separation and spaces are allowed. The number of parameters allowed in a single command is limited only by the number of individual parameters that command has.

<Command> {Port} {Param1 [= Value]}, {Param2 [= Value]}, {Etc.}

Examples: ZoneLineOut C Treble = -12, Mute, Delay = 100

HDBT_Out A VideoSrc = HDMI_In 1, AudioSrc = HDMI_In 1

- **Multi-Parameter Command Format (ZoneAvPair)**

The “VideoSrc”, “AudioSrc” and “Load” parameters may be combined on a ZoneAvPair command. Note that the “,” character is used for separation.

ZoneAvPair HDBT_Out {Port} Slot {Slot} {Param1=Value}, {Param2=Value}

Example:

ZoneAvPair HDBT_Out B Slot 5 VideoSrc=HDMI_In 2, AudioSrc=CoaxIn 1



- **Complex Multi-Port/Parameter Command Format**

It is possible to have a single command that affects multiple ports with multiple groupings of parameters. All previously explained syntax rules must be observed and each additional set of ports/parameters are separated by the "&" character.

<Command> {Port1}+{Port2}+{Etc.} {Param1 [= Value]}, {Param2 [= Value]}, {Etc.} & {Port1}+{Port2}+{Etc.} {Param1 [= Value]}, {Param2 [= Value]}, {Etc.} & Etc.

Example:

HDBT_Out A+C+E VideoSrc=HDMI_In 2, AudioSrc=CoaxIn 1 & B+D Mute & F VideoSrc=HDMI_In 1, AudioSrc=HDMI_In 1

- **Complex Multi-Slot/Parameter Command Format (ZoneAvPair)**

The ZoneAvPair command can also control multiple slots with multiple parameter groupings however the syntax is slightly different. Each command can only affect a single port at a time. Each additional set of slots/parameters are separated by the "&" character.

ZoneAvPair HDBT_Out {Port} Slot {Slot1}+{Slot2}+{Etc.} {Param1=Value}, {Param2=Value} & Slot {Slot1}+{Slot2}+{Etc.} {Param1=Value}, {Param2=Value} & Etc.

Example:

ZoneAvPair HDBT_Out B Slot 1 VideoSrc=HDMI_In 2, AudioSrc=CoaxIn 1 & Slot 2+3+4 VideoSrc=HDMI_In 2, AudioSrc=AnalogIn 1 & Slot 5+6 VideoSrc=HDMI_In 1, AudioSrc=HDMI_In 1 & Slot 1 Load

6.8.2 Real World Command Use

- **Zone A/V Pairing Mode Command Example**

The easiest way to use the matrix for simple HDMI switching while still allowing for individually tailored zone audio is to use the Zone A/V Pairing setting within the WebGUI.

This is a configured and saved setting allowing each HDMI input to be paired with different audio inputs, depending on the zone it is being output to, for easy selection from a remote within that zone. For example, certain zones might not be able to handle surround sound, so you can pair the video in that zone with stereo inputs. Please review to section 6.10.6 for details of Zone A/V Pairing configuration.

COMMAND	DESCRIPTION
ZoneAvPair HDBT_Out A Slot 1 Load	Load the 1st A/V pairing for HDBaseT Output A's zone

- **Optical Audio Return (OAR) Command Example**

If you are also using the Zone Audio outputs (Stereo Zones) for any zone we recommend using the Optical Audio Return (OAR) function to set the Zone Audio output to always play the audio coming from the TV itself. In this way the end user can freely switch between the matrix input on the TV and the internal tuner/smart functions of the TV and always be guaranteed audio (remember to set the TV's optical output to LPCM 2.0).

This command only needs to be resent after an audio only source has been selected for that individual Zone Audio output. Commonly a control system would have a "TV" button in the audio source selection area along with your other audio sources.

COMMAND	DESCRIPTION
ZoneLineOut A AudioSrc=OAR_In A	Zone Audio output "A" plays OAR audio from the TV connected to HDBaseT output "A"

- **HDMI Mirroring Command Example**

If you have rack (head end) based AVR's for surround sound rooms we recommend using the HDMI outputs and the HDMI mirroring mode to easily have the audio and video sent to the AVR follow the signal sent to that zone's TV.

As long as no further commands are ever sent to the HDMI outputs of the matrix you only need to set this up once:

COMMAND	DESCRIPTION
HDMI_Out H Mirroring=HDBT_Out A	Set HDMI output "H" to mirror HDBaseT output "A"

When using the mirroring function you can use any standard commands with the mirrored HDBaseT output and the mirroring HDMI output will follow the commands. These can be an A/V Pairing, Video or Audio commands, etc.



• Audio Only source selection Command Examples

This unit offers 4 direct audio only inputs, while some of these inputs will likely be used for down mixed audio signals from surround sound sources (for stereo only zones) we expect audio only sources to be connected to deliver just audio to both TV zones and Audio Only zones.

COMMAND	DESCRIPTION
ZoneLineOut A AudioSrc=AnalogIn 1	Route Analog input 1 to Zone Audio output "A"
ZoneLineOut A AudioSrc=OpticIn 1	Route Optical input 1 to Zone Audio output "A"
ZoneLineOut A AudioSrc=CoaxIn 1	Route Coaxial input 1 to Zone Audio output "A"
ExtLineOut 1 AudioSrc=AnalogIn 1	Route Analog input 1 to Extended Line output "1"
ExtLineOut 1 AudioSrc=OpticIn 1	Route Optical input 1 to Extended Line output "1"
ExtLineOut 1 AudioSrc=CoaxIn 1	Route Coaxial input 1 to Extended Line output "1"

Above are just a few example of the audio selections available. Please refer to the full command listing for all possible commands. Remember if you have configured any audio zones to play the OAR audio from the TV within a zone you must be able to select this again to return to "listening" to that TV.

• Individual Audio and Video Routing Command Examples

To offer the greatest level of flexibility the matrix can be used to send individual commands for both video and audio, this allows the installer to completely tailor the matrix to suit any possible configuration the end user may require.

Route audio and video from HDMI input 1 to HDBaseT output A independently:

COMMAND	DESCRIPTION
HDBT_Out A VideoSrc=HDMI_In 1	Video switch command
HDBT_Out A AudioSrc=HDMI_In 1	Audio switch command

• Combined Audio and Video Routing Command Example

It is also possible to switch audio and video simultaneous by using an advanced command structure. In this case the individual parameters of the “HDBT_Out” command are separated by a comma. Please check section 6.8.1 for additional information on how commands can be combined.

Route audio and video from HDMI input 1 to HDBaseT output A simultaneously:

COMMAND	DESCRIPTION
HDBT_Out A VideoSrc=HDMI_In 1, AudioSrc=HDMI_In 1	Video and Audio switch command

Every individual audio and video input has a bespoke command (including separate commands for the audio and video within a HDMI source).

6.8.3 Full Command List

COMMAND	DESCRIPTION
Help	Display all available commands. (Except hidden commands.)
?	Display all available commands. (Except hidden commands.)
Help {Command}	Detailed description of the specified command.
? {Command}	Detailed description of the specified command.
SaveMuteSetting ?	Display the current Save Mute Setting configuration.
SaveMuteSetting XXX	Allow or disallow saving the audio mute setting when the unit is powered off. XXX = "On" or "Off"

COMMAND	DESCRIPTION
ZoneLineOut M AudioSrc=XXX	Set the audio source for a zone line output. M = A~F Available XXX values: HDMI_In n [n=1~6] OpticIn n [n=1] CoaxIn n [n=1] AnalogIn n [n=1~2] OAR_In n [n=A~F]
ZoneLineOut M Treble=XXX	Set the treble value for a zone line output. M = A~F XXX = -12~+12 (units: dB)
ZoneLineOut M Bass=XXX	Set the bass value for a zone line output. M = A~F XXX = -12~+12 (units: dB)
ZoneLineOut M Volume=XXX	Set the volume for a zone line output. M = A~F XXX = 0 ~ -100 (units: dB)
ZoneLineOut M Volume=Fast XXX	Adjust the volume of a zone line output in large steps (2dB steps). M = A~F XXX = "Up" or "Down"

COMMAND	DESCRIPTION
ZoneLineOut M Volume=Slow XXX	Adjust the volume of a zone line output in small steps (0.5dB steps). M = A~F XXX = "Up" or "Down"
ZoneLineOut M Delay=XXX	Set the audio delay for a zone line output. M = A~F XXX = 0~230 (units: ms)
ZoneLineOut M Mute	Mute a zone line output. M = A~F
ZoneLineOut M Unmute	Unmute a zone line output. M = A~F
ZoneLineOut M Status	Display the status of a zone line output. M = A~F
ZoneLineOut M Name={NameString}	Set the verbose name of a zone line output. Maximum 32 characters. M = A~F Note: Can only rename one port at a time. Multi-port is not supported.

COMMAND	DESCRIPTION
ExtLineOut M AudioSrc=XXX	Set the audio source for an extended line output. M = 1~2 Available XXX values: HDMI_In n [n = 1~6] OpticIn n [n = 1] CoaxIn n [n = 1] AnalogIn n [n = 1~2] OAR_In n [n = A~F]
ExtLineOut M Treble=XXX	Set the treble value for an extended line output. M = 1~2 XXX = -12~+12 (units: dB)
ExtLineOut M Bass=XXX	Set the bass value for an extended line output. M = 1~2 XXX = -12~+12 (units: dB)
ExtLineOut M Volume=XXX	Set the volume for an extended line output. M = 1~2 XXX = 0 ~ -100 (units: dB)
ExtLineOut M Volume=Fast XXX	Adjust the volume of an extended line output in large steps (2dB steps). M = 1~2 XXX = "Up" or "Down"

COMMAND	DESCRIPTION
ExtLineOut M Volume=Slow XXX	Adjust the volume of an extended line output in small steps (0.5dB steps). M = 1~2 XXX = "Up" or "Down"
ExtLineOut M Delay=XXX	Set the audio delay for an extended line output. M = 1~2 XXX = 0~230 (units: ms)
ExtLineOut M Mute	Mute an extended line output. M = 1~2
ExtLineOut M Unmute	Unmute an extended line output. M = 1~2
ExtLineOut M Status	Display the status of an extended line output. M = 1~2
ExtLineOut M Name={NameString}	Set the verbose name of an extended line output. Maximum 32 characters. M = 1~2 Note: Can only rename one port at a time. Multi-port is not supported.

COMMAND	DESCRIPTION
HDMI_Out M AudioSrc=XXX	Set the audio source for an HDMI output. M = G~H Available XXX values: HDMI_In n [n = 1~6] OpticIn n [n = 1] CoaxIn n [n = 1] AnalogIn n [n = 1~2] OAR_In n [n = A~F] FollowVideo
HDMI_Out M Mute	Mute an HDMI output's audio. M = G~H
HDMI_Out M Unmute	Unmute an HDMI output's audio. M = G~H
HDMI_Out M VideoSrc=XXX	Set the video source for an HDMI output. M = G~H Available XXX values: HDMI_In n [n = 1~6]
HDMI_Out M VideoSrc=Pattern	Set the video source of an HDMI output to the internal test pattern. M = G~H
HDMI_Out M VideoSrc=Default	Reset the video source of an HDMI output to the factory default. M = G~H

COMMAND	DESCRIPTION
HDMI_Out M Mirroring=XXX	Set the audio/video mirroring source for an HDMI output. M = G~H Available XXX values: HDBT_Out n [n = A~F]
HDMI_Out M Status	Display the status & properties of an HDMI output including audio/video matrix. M = G~H
HDMI_Out M Name={NameString}	Set the verbose name of an HDMI output. Maximum 32 characters. M = G~H Note: Can only rename one port at a time. Multi-port is not supported.
HDBT_Out M AudioSrc=XXX	Set the audio source for an HDBaseT output. M = A~F Available XXX values: HDMI_In n [n=1~6] OpticIn n [n=1] CoaxIn n [n=1] AnalogIn n [n=1~2] OAR_In n [n=A~F] FollowVideo
HDBT_Out M Mute	Mute an HDBaseT output's audio. M = A~F

COMMAND	DESCRIPTION
HDBT_Out M Unmute	<p>Unmute an HDBaseT output's audio.</p> <p>M = A~F</p>
HDBT_Out M VideoSrc=XXX	<p>Set the video source for an HDBaseT output.</p> <p>M = A~F</p> <p>Available XXX values: HDMI_In n [n=1~6]</p>
HDBT_Out M VideoSrc=Pattern	<p>Set the video source of an HDBaseT output to the internal test pattern.</p> <p>M = A~F</p>
HDBT_Out M VideoSrc=Default	<p>Reset the video source of an HDBaseT Tx output to the factory default.</p> <p>M = A~F</p>
HDBT_Out M Status	<p>Display the status & properties of an HDBaseT output including audio/video matrix.</p> <p>M = A~F</p>
HDBT_Out M Name={NameString}	<p>Set the verbose name of an HDBaseT output. Maximum 32 characters.</p> <p>M = A~F</p> <p>Note: Can only rename one port at a time. Multi-port is not supported.</p>
HDMI_In M Status	<p>Display the status of an HDMI input.</p> <p>M = 1~6</p>

COMMAND	DESCRIPTION
HDMI_In M Name={NameString}	Set the verbose name of an HDMI input. Maximum 32 characters. M = 1~6 Note: Can only rename one port at a time. Multi-port is not supported.
SETIP {IP} {Subnet} {Gateway}	Set the IP address, subnet and gateway in Static IP mode. Address format: xxx.xxx.xxx.xxx
RSTIP	Request updated IP information from the DHCP server.
IPCONFIG	Display the current IP configuration.
P0	Enter light stand-by mode. (RS-232, Ethernet and PoH functionality is still active.)
P1	Turn the power on.
P2	Enter deep stand-by mode. (Only RS-232 functionality is still active.)
P?	Report the current power status.
PRESET Save M	Save the current A/V routing as a preset. M = 1~8
PRESET Load M	Load and activate a saved A/V preset. M = 1~8

COMMAND	DESCRIPTION
PRESET Show [M]	List the contents of a stored A/V preset. M = 1~8 (If M is omitted, list all A/V presets.)
PRESET name M={NameString}	Set the verbose name of a preset. Maximum 32 characters. M = 1~8
EDID All=XXX	Set the EDID source for all HDMI input ports. Available XXX values: 1~6 [Factory EDIDs] 7~14 [Connected sink EDIDs] 15~18 [User EDIDs]
EDID HDMI_In M=XXX	Set the EDID source for a single HDMI port. M = 1~6 Available XXX values: 1~6 [Factory EDIDs] 7~14 [Connected sink EDIDs] 15~18 [User EDIDs]
EDID M Name={NameString}	Set the verbose name of a user EDID slot. Maximum 16 characters. M = 15~18
Pattern	Display the current test pattern configuration.

COMMAND	DESCRIPTION
Pattern timing=XXX	Set the output resolution and timing used by the internal test pattern generator. Available XXX values: 4K2K30 4K2K25 1080p60 1080p50 720p60 720p50
Pattern type=XXX	Set the color to display the test pattern in. Available XXX values: Black Blue Green Cyan Red Magenta Yellow White
FactoryDefault	Reset all settings to their factory defaults. (Hidden command.)
MAC	Display the MAC address.
Ver	Display the firmware version.

COMMAND	DESCRIPTION
ZoneAvPair HDBT_Out M Slot N AudioSrc=XXX	Assign an audio source to a Zone A/V Pair slot on an HDBaseT output. M = A~F N = 1~11 Available XXX values: HDMI_In n [n=1~6] OpticIn n [n=1] CoaxIn n [n=1] AnalogIn n [n=1~2] OAR_In n [n=A~F]
ZoneAvPair HDBT_Out M Slot N VideoSrc=XXX	Assign a video source to a Zone A/V Pair slot on an HDBaseT output. M = A~F N = 1~11 Available XXX values: HDMI_In n [n=1~6] Pattern Note: HDMI_In is not available for use with slot 11.
ZoneAvPair HDBT_Out M Slot N Load	Load and activate the contents of a Zone A/V Pair slot on an HDBaseT output. M = A~F N = 1~11

COMMAND	DESCRIPTION
ZoneAvPair HDMI_Out M Slot N AudioSrc=XXX	Assign an audio source to a Zone A/V Pair slot on an HDMI output. M = G~H N = 1~11 Available XXX values: HDMI_In n [n=1~6] OpticIn n [n=1] CoaxIn n [n=1] AnalogIn n [n=1~2] OAR_In n [=A~F]
ZoneAvPair HDMI_Out M Slot N VideoSrc=XXX	Assign a video source to a Zone A/V Pair slot on an HDMI output. M = G~H N = 1~11 Available XXX values: HDMI_In n [n=1~6] Pattern Note: HDMI_In is not available for use with slot 11.
ZoneAvPair HDMI_Out M Slot N Load	Load and activate the contents of a Zone A/V Pair slot on an HDMI output. M = G~H N = 1~11

COMMAND	DESCRIPTION
IR_Route HDBT_Out M0 M1 M2	<p>Select the IR source(s) for an HDBaseT output.</p> <p>M0 is the output port index. M1 is the function to use. M2 is the IR input source.</p> <p>M0 = A~F (supports multiple port selection by using "+".)</p> <p>Available M1 values: Add [Add M2 source to M0] Del [Remove M2 source from M0]</p> <p>Available M2 values: IR_InAll [IR In (ALL) input jack] Generator [Internal IR encoder]</p>
IR_Route HDBT_Out M0 Show	<p>Display the current IR source of the HDBaseT output.</p> <p>M0 = A~F (supports multiple port selection by using "+".)</p>

COMMAND	DESCRIPTION
IR_Route IR_Out M0 M1 M2	<p>Select the IR source(s) for an IR Output jack (next to each HDMI input).</p> <p>M0 is the output port index. M1 is the function to use. M2 is the IR input source.</p> <p>M0 = 1~6 (supports multiple port selection by using "+".)</p> <p>Available M1 values: Add [Add M2 source to M0] Del [Remove M2 source from M0]</p> <p>Available M2 values: IR_InAll [IR In (ALL) input jack] Generator [Internal IR encoder]</p>
IR_Route IR_Out M0 Show	<p>Display the current IR source for an IR Output jack (next to each HDMI input).</p> <p>M0 = 1~6 (supports multiple port selection by using "+".)</p>

Note: Commands will not be executed unless followed by a carriage return. Commands are not case-sensitive.

6.9 Telnet Control

Before attempting to use Telnet control, please ensure that both the unit and the PC/Laptop are connected to the same active networks.

To access Telnet in Windows 7, click on the “Start” menu and type “cmd” in the search field, then press “Enter”.

Under Windows XP go to the “Start” menu, click on “Run”, type “cmd” then press “Enter”.

Under Mac OS X, go to Go → Applications → Utilities → Terminal.

See below for reference.

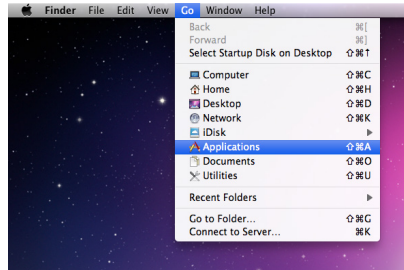
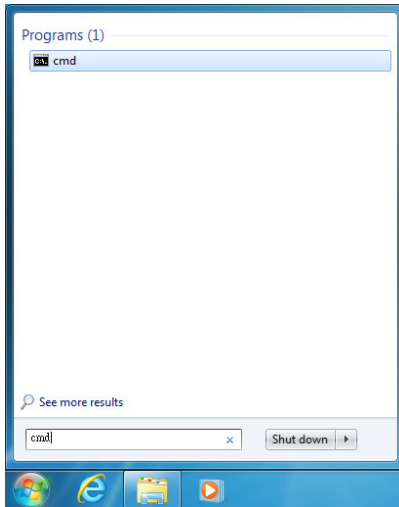

Once in the CLI (Command Line Interface) type “Telnet” followed by the IP address of the unit and “23”, then hit “Enter”.

```
Microsoft Windows [Version 6.1.7601]
Copyright (c) 2009 Microsoft Corporation. All rights reserved.

C:\Users\Administrator>telnet 192.168.5.80 23
```

This will connect us to the unit we wish to control. Type “help” to list the available commands.

```
Help           : Console command online help.
?             : Console command online help.
IPCONFIG       : List IP configurations.
SetIP          : IP configurations.
RSTIP         : Enable DHCP mode.
P0            : Power off with network.
P1            : Power on.
P2            : Power off everything.
P?           : Power state.
ZoneLineOut   : Zone line out configurations.
ExtLineOut    : Extended line out configurations.
Pattern       : Pattern mode configuration.
HDMI_Out      : HDMI output configurations.
HDBT_Out      : HDBT output configurations.
Preset        : Audio/Video preset manipulation.
HDMI_In       : HDMI input configurations.
EDID          : EDID specifier of each input port.
Ver           : Version report.
ZoneAvPair    : Zone Audio/Video pairing configuration.
IR_Route      : IR routing configuring.
DiscreteIr    : Discrete IR setting command.
IrRemote      : IR remote controller setting command.
Uart          : Uart:==>Under construction...
```

Note: Commands will not be executed unless followed by a carriage return. Commands are not case-sensitive. If the IP address is changed then the IP address required for Telnet access will also change accordingly.

6.10 WebGUI Control

- **Install the Device Discovery Tool**

Please obtain the Device Discovery software from your authorized dealer and save it in a directory where you can easily find it.

Note: The unit's default IP address is 192.168.1.50

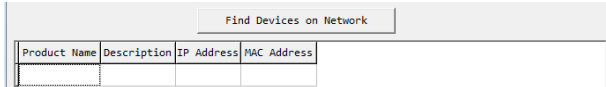

Connect the unit and your PC/Laptop to the same active network and execute the Device Discovery software. Click on “Find Devices on Network” and a list of devices connected to the local network will show up indicating their current IP address.

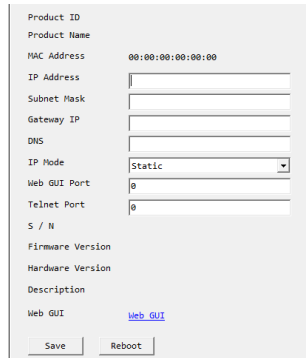

By clicking on one of the listed devices you will be presented with the network details of that particular device. If you choose, you can alter the static IP network settings for the device, or switch the unit into DHCP mode to automatically obtain proper network settings from a local DHCP server. To switch to DHCP mode, please select DHCP from the IP mode drop-down, then click “Save” followed by “Reboot”.

Once you are satisfied with the network settings, you may use them to connect via Telnet or WebGUI. The network information window provides a convenient link to launch the WebGUI directly.

- **Login to the WebGUI**

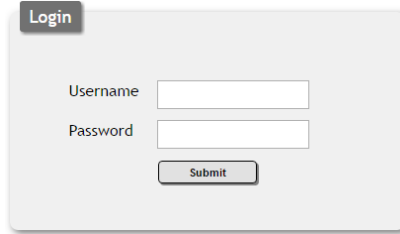

A login form with a grey background and rounded corners. At the top left is a dark grey button labeled "Login". Below it are two white input fields: "Username" and "Password". At the bottom center is a grey button labeled "Submit".

By default, both the Username and Password are “admin” for the WebGUI. The administrator password can be changed within the “User Config” tab of the WebGUI if desired.

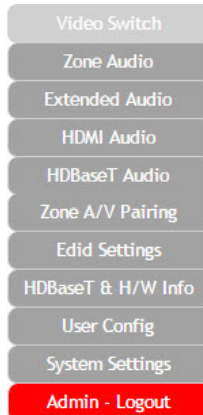

The above function tabs will always display on left side of the WebGUI to aid with navigation.

6.10.1 Video Switch

This page provides video routing settings including HDCP and test pattern configuration.

- **Output and Input Routing**

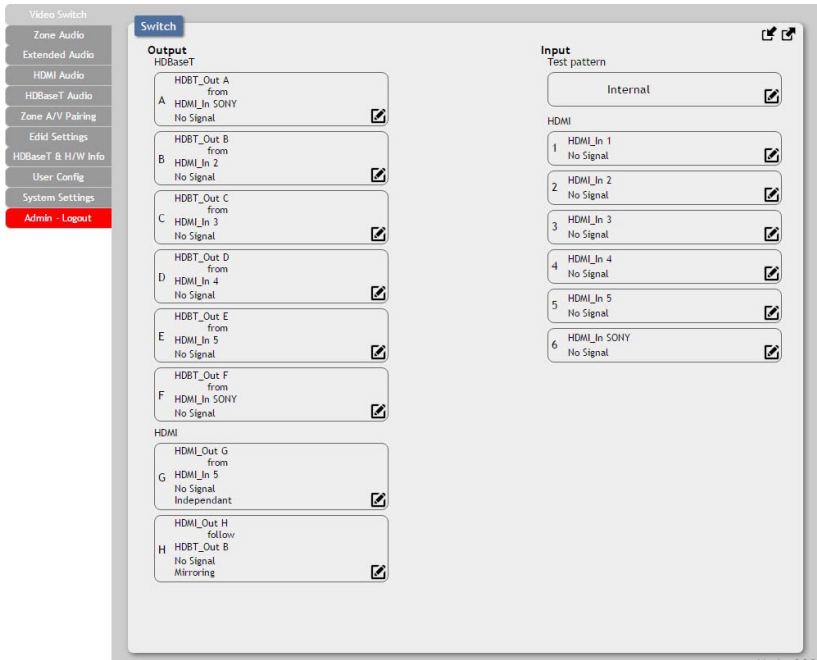

To begin assigning a new video route, please click the button of the HDBaseT output you wish to send video to (e.g. "HDBT_Out A") and then click on the button of the preferred HDMI input port (e.g. "HDMI_In 1"). If desired, you may select more than one output prior to selecting the input. As you select each button they will change their color to orange. The new route will become active immediately and the routing information displayed on the buttons will change accordingly.

If you need to route an input to multiple outputs, please select all of the appropriate output buttons before selecting the input port.

• Output and Input Naming

The screenshot displays the 'Switch' configuration page. On the left is a navigation menu with options like 'Zone Audio', 'HDMI Audio', and 'Admin - Logout'. The main area is divided into 'Output' and 'Input' sections. The 'Output' section contains HDBaseT outputs (A-H) and HDMI outputs (G-H). Each output has a name, a source, and a signal status, along with an edit icon. An 'Output Edit' dialog box is open for 'HDBT_Out A', showing a text field with 'HDBT_Out A' and a 'Save' button. A red arrow points to the edit icon for 'HDBT_Out B'.

All inputs and outputs can be renamed as required. To rename the HDBaseT output ports and HDMI input ports please click the “edit” icon (✎). Click the “Save” button to confirm the change.

Note: Blank spaces (“ ”) are not allowed in names.

• HDMI Output Setting

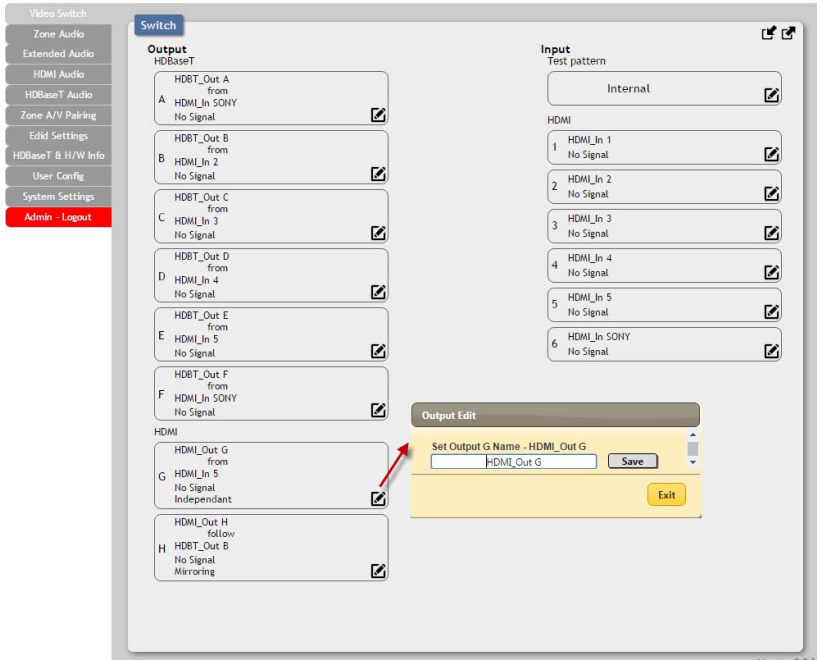

The two HDMI outputs (port G & port H) allow support for the maximum HDMI timing up to 18Gbps (4096×2160@60Hz) and can be used for normal source routing (listed as “Independent” within the WebGUI) and mirroring (listed as “Mirror” within the WebGUI) for local monitoring purposes or zone monitoring (e.g. The HDBaseT output connects to a TV in a remote zone the local HDMI connection goes into an AVR).

Click the “edit” icon (✎) to toggle the HDMI output mode between “Independent” and “Mirror”. When an HDMI port is in “Mirror” mode you can only select HDBaseT outputs as inputs.

• Internal Test Pattern

This advanced matrix system comes with an internal test pattern generation feature which can be used to test connected sink device functionality or be used to self-test matrix unit itself. This is a useful tool for installation engineers to troubleshoot potential issues between the matrix and connected devices.

This can also be used as a video source for any connected “audio only” sources in cases where only a TV is available for audio reproduction and it requires an active video source in order for the audio to be heard.

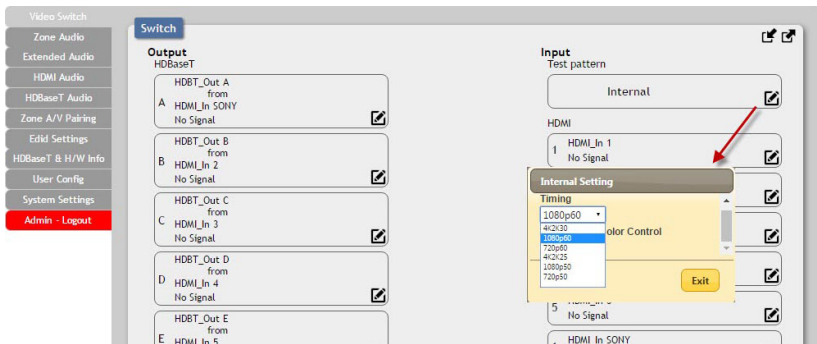

- **Timing:** Test patterns can be generated with the following standard timings: 720p@50/60Hz, 1080p@50/60Hz, 4K@25/30Hz. Test pattern output does not use HDCP.

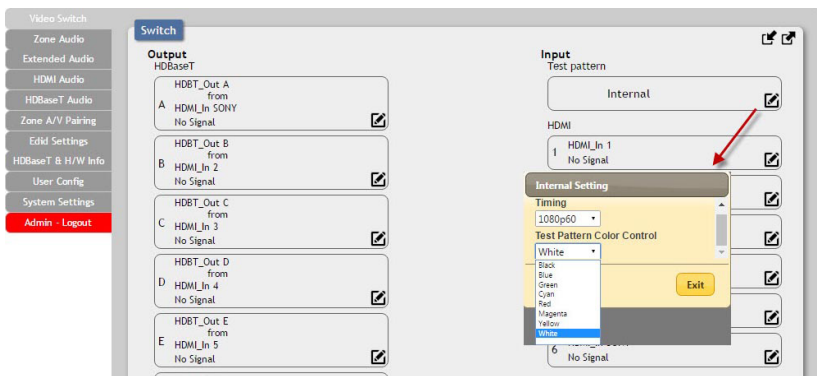

- **Color:** The test pattern can be changed to any one of a choice of eight colors.

• Preset Setting

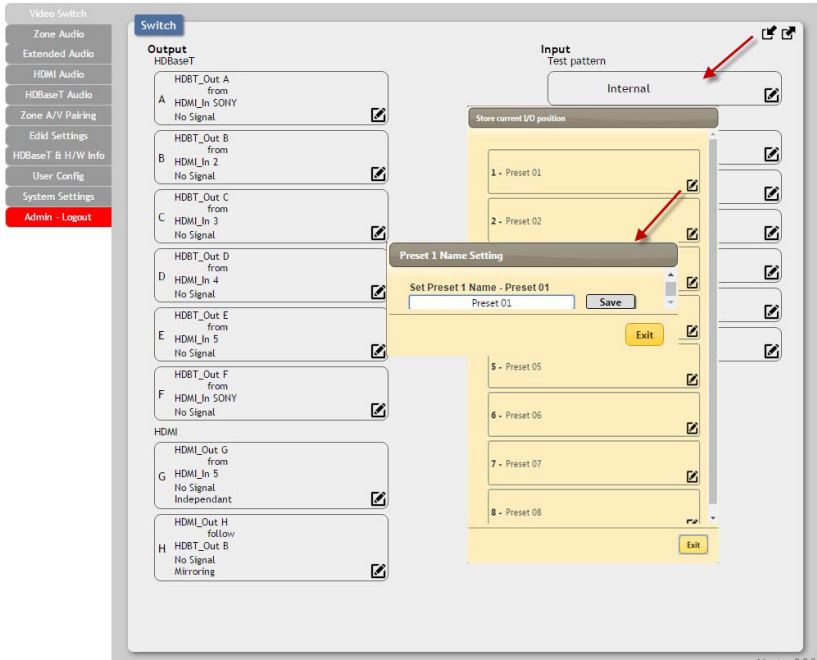

This matrix can store up to eight video and audio routing presets. Presets can be utilized to store multiple different routing states in advance for rapid, hassle-free, recall.

- **Store:** Once you have the matrix set the way you like, you can click the “store” icon (📌) in the upper right corner of the window. You may also name the preset at this stage by selecting the “edit” icon (✎). Click “Save” when you are ready to commit the preset to memory.
- **Recall:** When you wish to load a previously stored setting, please click the “recall” icon (📌) and you will be presented with a choice of the available 8 presets. The preset will load immediately upon selecting the preset.

6.10.2 Zone Audio

This advanced matrix offers a complete audio routing function. The Zone Audio ports offer analog audio breakaway capability. The audio source, treble, bass, volume and audio delay adjustments can be set on this page.

- **Output and Input Routing**

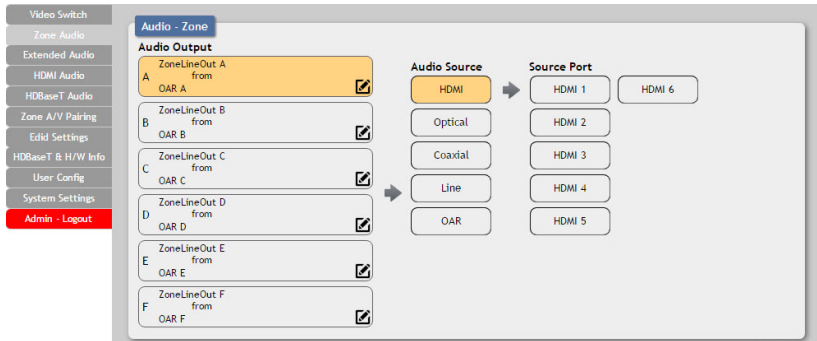

Click the buttons from left to right to choose each output's source. Once the new source has been selected, the change will happen immediately. Audio source options include HDMI, Optical, Coaxial, Line, and OAR.

• Audio Output Setting

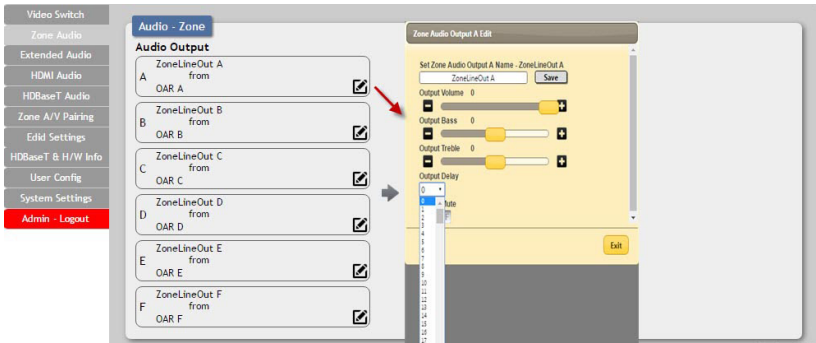

Click the “edit” icon () to change the following settings:

- **Rename:** The Zone Audio outputs can be renamed here.
- **Volume:** Adjustable from -100dB to 0dB.
- **Bass:** Adjustable from -12dB to +12dB.
- **Treble:** Adjustable from -12dB to +12dB.
- **Delay:** Adjustable from 0 to 230ms.
- **Mute:** Mute may be turned on or off.

6.10.3 Extended Audio

The Extended Audio ports offer additional analog audio breakaway capability. The audio source, treble, bass, volume and audio delay adjustments can be set on this page.

- **Output and Input Routing**

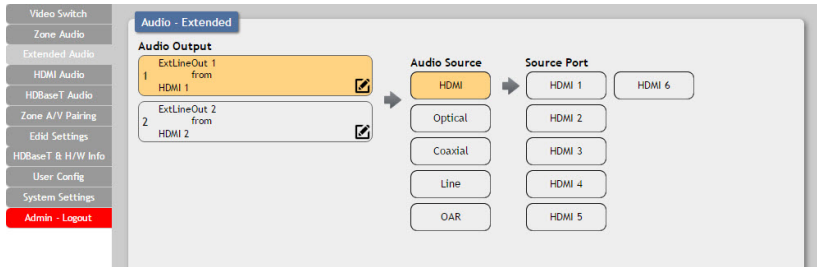

Click the buttons from left to right to choose each output's source. Once the new source has been selected, the change will happen immediately. Audio source options include HDMI, Optical, Coaxial, Line, and OAR.

- **Extended Audio Output Setting**

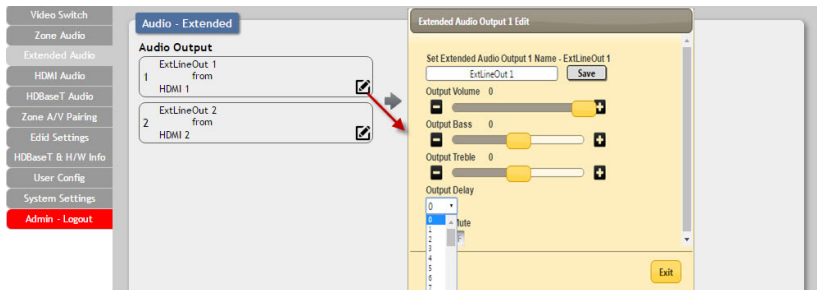

Click the "edit" icon (📄) to change the following settings:

- **Rename:** The Zone Audio outputs can be renamed here.
- **Volume:** Adjustable from -100dB to 0dB.
- **Bass:** Adjustable from -12dB to +12dB.
- **Treble:** Adjustable from -12dB to +12dB.
- **Delay:** Adjustable from 0 to 230ms.
- **Mute:** Mute may be turned on or off.

6.10.4 HDMI Audio

The audio routed to the two HDMI outputs (ports: G & H) and their associated settings are adjusted on this page.

- **Output and Input Routing**

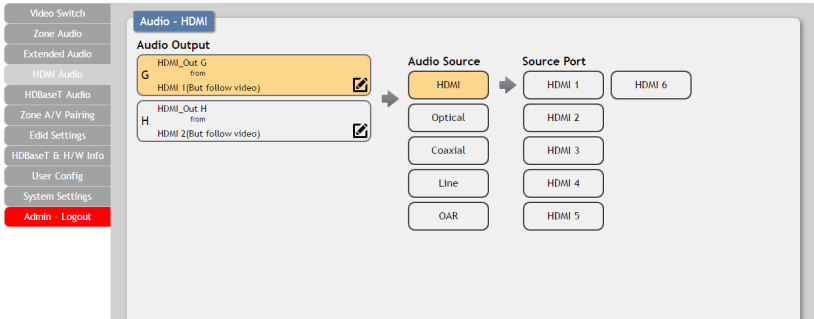

Click the buttons from left to right to choose each output's source. Once the new source has been selected, the change will happen immediately. Audio source options include HDMI, Optical, Coaxial, Line, and OAR.

- **HDMI Audio Output Setting**

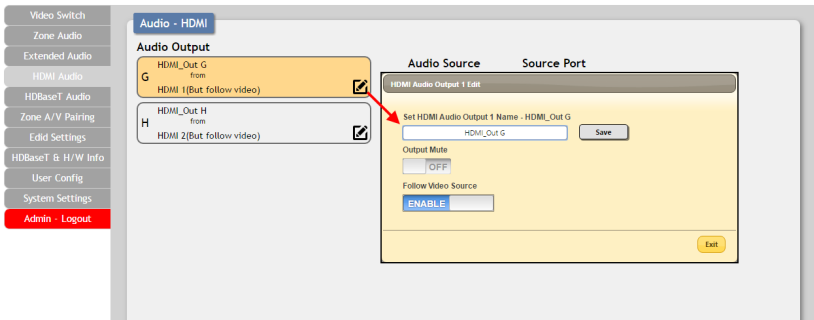

Click the "edit" icon (✎) to change the following settings:

- **Rename:** The HDMI Audio outputs can be renamed here.
- **Mute:** Mute may be turned on or off.
- **Follow Video Source:** Clicking the selection bar switches between Enable (follow video) and Disable (don't follow video).

6.10.5 HDBaseT Audio

The audio routed to the six HDBaseT outputs (ports: A~F) and their associated settings are adjusted on this page.

- **Output and Input Routing**

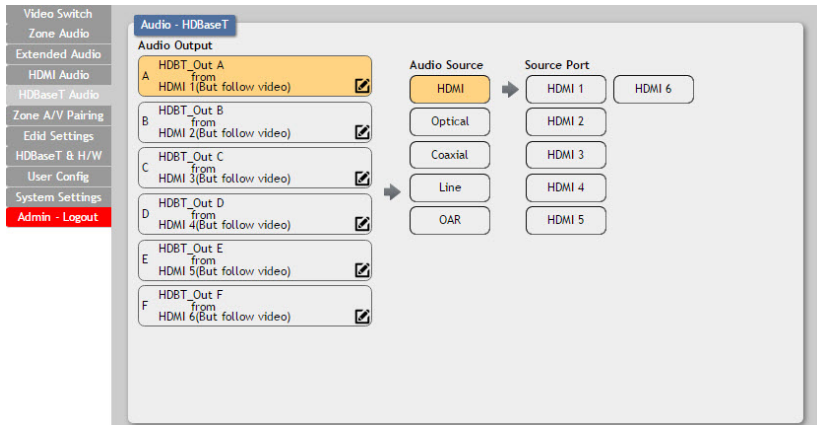

Click the buttons from left to right to choose each output's source. Once the new source has been selected, the change will happen immediately. Audio source options include HDMI, Optical, Coaxial, Line, and OAR.

• HDBaseT Audio Output Setting

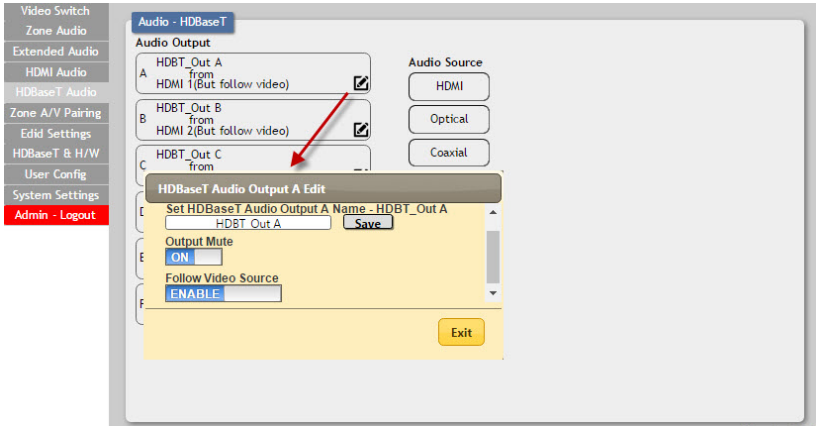

Click the "edit" icon (✎) to change the following settings:

- **Rename:** The HDBaseT Audio outputs can be renamed here.
- **Mute:** Mute may be turned on or off.
- **Follow Video Source:** Clicking the selection bar switches between Enable (follow video) or Disable (don't follow video).

6.10.6 Zone A/V Pairing

The zone A/V pairing function allows the end user to control the matrix, using the supplied remote control, in a customized manner while in remote rooms (zones) containing an HDBaseT receiver and IR extender.

Each zone can have a different set of video/audio sources assigned to the buttons on the remote control for easy switching. The video and audio routing selections for each of the six HDBaseT outputs need to be set up via the WebGUI in advance.

After setting them all up, the end user just needs to press a number key on the remote control unit once to change the routing status in whichever zone they are currently occupying. The distinct zone pairings can also be activated from within the WebGUI or by using Telnet/RS-232 commands.

- **Quick Button Selection**

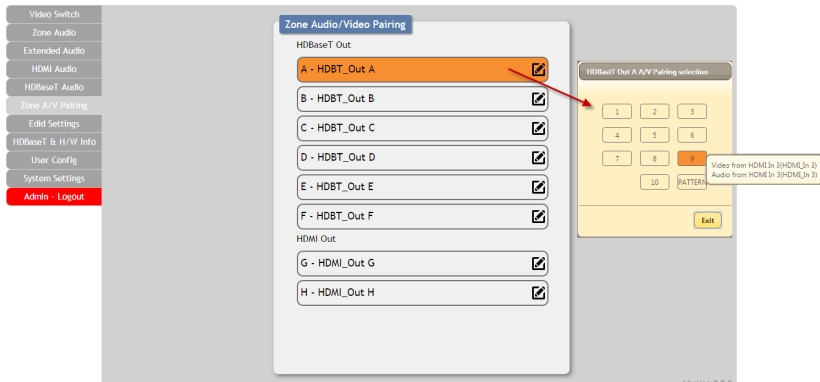

Please select the HDBaseT output port first and then click the “edit” icon (📄) to launch the window for further adjustments. The numbers 1~10 and “pattern” correspond to the keys on remote control unit.

• Video and Audio Pairing Edit

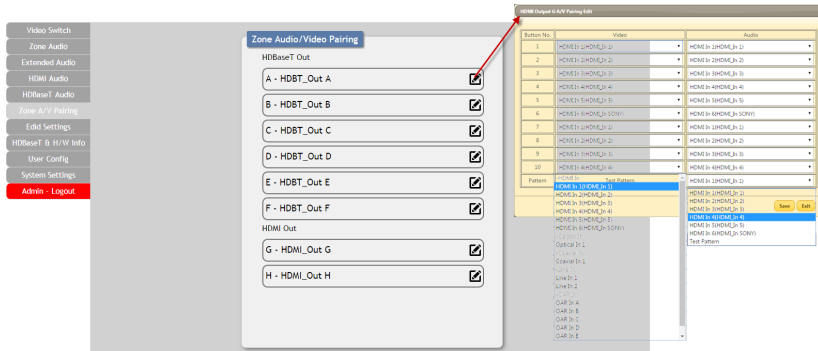

Please click the “edit” icon (✎) to edit the video and audio routing settings. Once you have completed your selections press “Save”.

6.10.7 EDID Settings

This matrix provides the option of six standard EDIDs, eight sink sourced EDIDs and four customer uploaded EDIDs that can be assigned to each input port individually. The names of the four customer uploaded EDIDs can be changed if desired.

• Customer EDID Settings

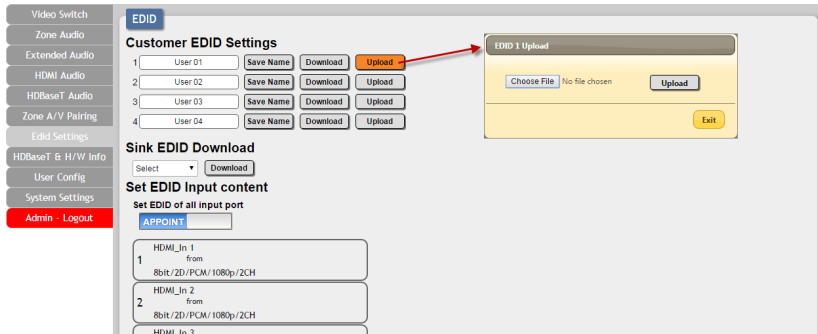

To upload a custom EDID, please click the “Upload” button next to the Customer EDID Settings item you would like to change. An EDID Upload window will appear, allowing you to locate and upload your preferred EDID file from the file directory on your local PC. Once the correct file has been selected, please click the “Upload” button in the window, and the file will be transferred to the matrix.

• Sink EDID Download

The screenshot shows the EDID configuration page. On the left is a navigation menu with options like Video Switch, Zone Audio, Extended Audio, HDMI Audio, HDBaseT Audio, Zone A/V Pairing, Edid Settings, HDBaseT & H/W Info, User Config, System Settings, and Admin - Logout. The main content area is titled 'EDID' and contains two sections: 'Customer EDID Settings' and 'Sink EDID Download'. The 'Customer EDID Settings' section has a table with 4 rows, each representing a user (User 01 to User 04) with 'Save Name', 'Download', and 'Upload' buttons. The 'Sink EDID Download' section has a 'Select' dropdown and a 'Download' button. Below this is the 'Set EDID Input Content' section, which is currently empty.

To save an existing custom EDID to your local PC please press the “Download” button next to the Customer EDID Settings item you would like to save. An EDID Download window will appear, allowing you to save the EDID file to your local PC. Once a file save location has been selected, please click the “Download” button in the window, and the file will be transferred to your PC.

• Set EDID Input Content

The screenshot shows the EDID configuration page with the 'Set EDID Input Content' section active. It features a list of input ports (HDMI_In 1 to HDMI_In 6) with a selection bar on the left. An arrow points from this list to an 'Edid Source' table. The 'Edid Source' table has columns for EDID format, Sink, and User. The first row is highlighted in yellow, showing '8bit/2D/PCM/1080p/2CH' assigned to Sink B and User 01.

Edid Source	Sink	User
8bit/2D/PCM/1080p/2CH	Sink B	User 01
8bit/2D/PCM/1080p/1MCH	Sink C	User 02
8bit/2D/PCM/4K2K@30/2CH	Sink D	User 03
8bit/2D/PCM/4K2K@30/1MCH	Sink E	User 04
8bit/2D/PCM/4K2K@60/2CH	Sink F	
8bit/2D/PCM/4K2K@60/1MCH	Sink G	
Sink A	Sink H	

The Set EDID Input Content section allows for the assignment of an EDID to each individual input port, or to all inputs at once. Click the selection bar to toggle between individual assignment, or all inputs.

The unit comes with the following 6 default EDIDs:

- **FHD/2CH:** 1080p/60Hz(148M), 2.0 LPCM, 8-bit color.
- **FHD/MCH:** 1080p/60Hz(148M), 7.1 LPCM and bitstream, 8-bit color.
- **4K UHD/2CH:** 3840×2160p/30Hz (297M), 2.0 LPCM, deep color (8/10/12-bit).
- **4K UHD/MCH:** 3840×2160p/30Hz (297M), 7.1 LPCM and bitstream, Deep Color (8/10/12-bit).
- **4K UHD+/2CH :** 3840×2160p/60Hz (594M), 2.0 LPCM, deep color (8/10/12-bit).
- **4K UHD+/MCH:** 3840×2160p/60Hz (594M), 7.1 LPCM and bitstream, deep color (8/10/12-bit).

Note: In some rare cases it is possible for custom or external EDIDs to cause compatibility issues with certain sources. If this happens, it is recommended to switch to one of the 6 default EDIDs for maximum compatibility.

6.10.8 HDBaseT & H/W Info

The screenshot shows the 'HDBaseT & Hardware Information' page. On the left is a navigation menu with options: Video Switch, Zone Audio, Extended Audio, HDMI Audio, HDBaseT Audio, Zone A/V Pairing, Edid Settings, HDBaseT & H/W Info (selected), User Config, System Settings, and Admin - Logout. The main content area is titled 'HDBaseT & Hardware Information' and contains the following data:

Hardware monitor
 Area 1 : 31 °C
 Area 2 : 44 °C
 Area 3 : 45 °C

HDBaseT Information

Port	Local FwID	Remote FwID
A	VS010 Tx v3100.3	-
B	VS010 Tx v3100.3	-
C	VS010 Tx v3100.3	-
D	VS010 Tx v3100.3	-
E	VS010 Tx v3100.3	-
F	VS010 Tx v3100.3	-

This page provides information concerning the temperature inside the matrix (areas 1, 2 & 3) and the HDBaseT firmware versions used in the matrix and in connected receivers. Temperature area 1 is the left side of the output ports (from the front), area 2 is the right side of the output ports (from the front) and area 3 is at the middle of the HDMI inputs.

6.10.9 User Config

The WebGUI and Telnet username/password are set on this page. Two management levels are available: “Administrator” and “General User”. The administrator username (“admin”) cannot be changed. The “Administrator” user has access to change all settings. The “General User” is not permitted to access or change information on the EDID Settings or System Settings pages.

6.10.10 System Settings

This page provides system configuration options including turning the power on/off, changing the network settings, downloading/restoring saved system configurations, resetting the system to factory defaults and updating the firmware.

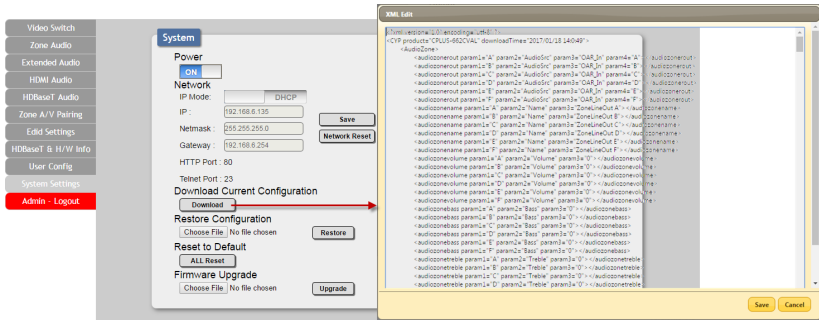

Click the “Download” button to save the current system configuration to your local PC. The current system configuration will be saved as XML file. The system configuration can also be restored from a saved XML file by clicking the “Choose File” button to locate the saved XML file, then clicking the “Restore” button.

6.10.11 Logout

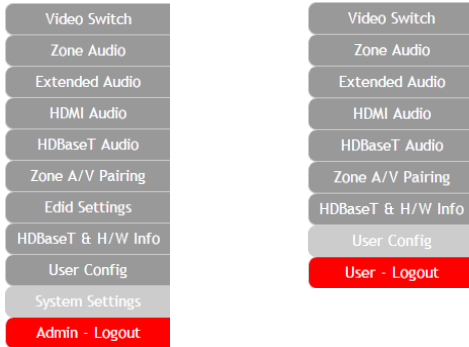

The “Logout” tab will indicate if the current user is connected as an Administrator or General User. Clicking the “Logout” tab will automatically log the user out of the WebGUI and return to login page.

7. CONNECTION DIAGRAM

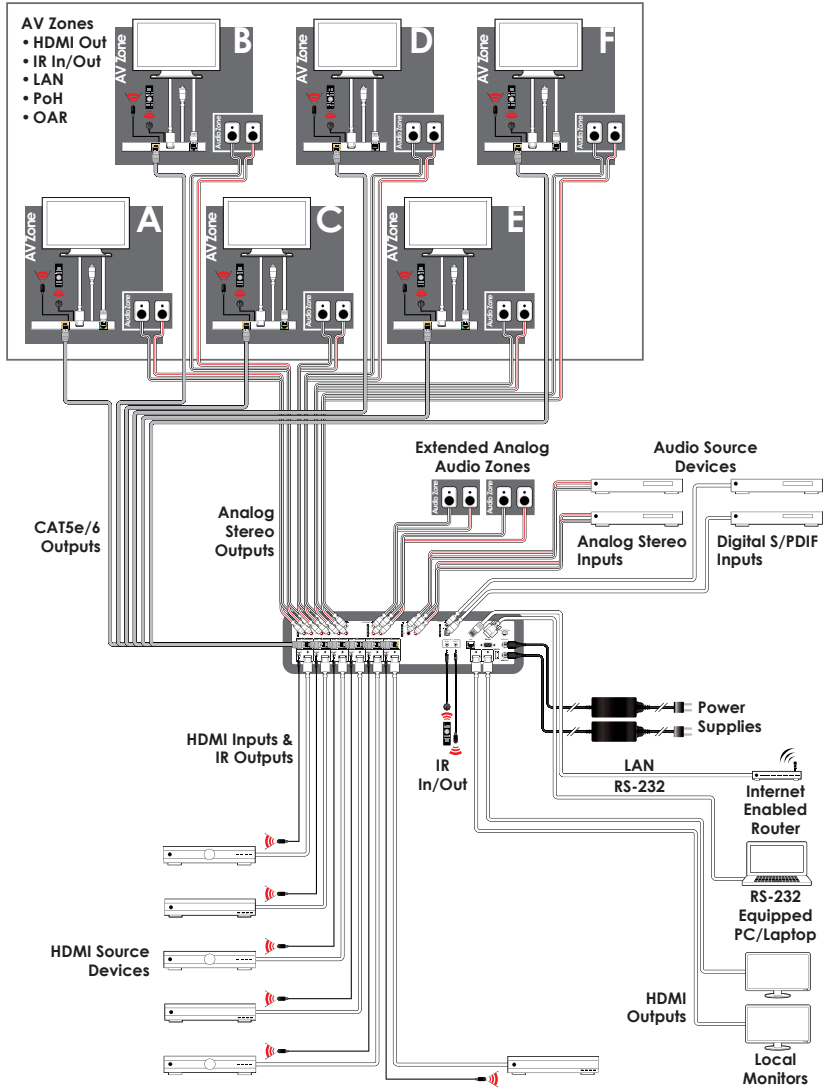



8. SPECIFICATIONS

8.1 Technical Specifications

Video Bandwidth	HDMI: 600MHz/18Gbps HDBaseT: 340MHz/10.2Gbps
Input Ports	6×HDMI 4×RCA [Stereo Audio] 1×Coaxial [S/PDIF Audio] 1×Optical [S/PDIF Audio]
Output Ports	2×HDMI 6×Cat.5e/6/7 12×RCA [Stereo Audio] 4×RCA [Extended Stereo Audio]
Control Ports	7×IR Extender 7×IR Blaster 1×RS-232 (9-pin D-sub) 1×LAN (RJ-45)
Service Port	1×USB 2.0
IR Frequency	38kHz
Baud Rate	115200bps
Power Supply	24V/6.25A DC (US/EU standards, CE/FCC/ UL certified)
ESD Protection	Human Body Model: ±12kV (Air Discharge) ±8kV (Contact Discharge)
Dimensions	438mm×88mm×316mm (W×H×D) [Case Only] 483mm×96mm×356mm (W×H×D) [All Inclusive]
Weight	6,400g
Chassis Material	Metal

Silkscreen Color	Black
Operating Temperature	0°C - 40°C/32°F - 104°F
Storage Temperature	-20°C - 60°C/-4°F - 140°F
Relative Humidity	20 - 90% RH (No-condensing)
Power Consumption	140W

8.2 Video Specifications

8.2.1 Supported HDMI Resolutions

HDMI Resolution (Hz)	Input	Output
480i@60	✓	✓
480p@60	✓	✓
576i@60	✓	✓
576p@60	✓	✓
640×480@60	✓	✓
800×600@60	✓	✓
720p@50/60	✓	✓
1080i@50/60	✓	✓
1080p@24/50/60	✓	✓
1024×768@60	✓	✓
1280×1024@60	✓	✓
1360×768@60	✓	✓
1600×1200@60	✓	✓
1920×1200@60	✓	✓
2560×1440@60	✓	✓
3840×2160@24/25/30/50/59.94/60	✓	✓
4096×2160@24/50/59.94/60	✓	✓



8.2.2 Maximum HDMI Cable Length

HDMI Resolution	Input	Output
8-bit 1080p	10 meters	10 meters
12-bit 1080p	10 meters	10 meters
3840×2160@60Hz (YCbCr 4:2:0)	5 meters	5 meters
3840×2160@60Hz (YCbCr 4:4:4)	3 meters	3 meters

Note:

1. 18Gbps (4K@60Hz YCbCr 4:4:4) HDMI signals will be converted to 10.2Gbps (4K@60Hz YCbCr 4:2:0) signals when output over the six HDBaseT ports. Some TVs may not support YCbCr 4:2:0 color or 4K@60Hz and may display the signal incorrectly, or not at all. Please check your TV's technical specs before attempting to display 4K@60Hz signals.
2. The use of "Premium High Speed HDMI" cables is highly recommended.

8.3 Audio Specifications

8.3.1 Analog Audio

Analog Inputs	
Max Audio Level	2Vrms
Input Impedance	>10kΩ

Analog Outputs	
0dBFS Output Level	2Vrms
THD ≤ 80%	1K 0dBFS
THD ≤ 90%	1K -1dBFS
SNR	> 100dB @ 1K 0dBFS
Frequency Response	< ±0.5dB @ 20Hz~20KHz
Crosstalk	< 90dB @ 20hz~20Khz
Output Impedance	> 470Ω

8.3.2 Linear PCM Audio

Channels (kHz)		
LPCM 2.0@44.1	LPCM 5.1@44.1	LPCM 7.1@44.1
LPCM 2.0@88.2	LPCM 5.1@88.2	LPCM 7.1@88.2
LPCM 2.0@176.4	LPCM 5.1@176.4	LPCM 7.1@176.4
LPCM 2.0@32	LPCM 5.1@32	LPCM 7.1@32
LPCM 2.0@48	LPCM 5.1@48	LPCM 7.1@48
LPCM 2.0@96	LPCM 5.1@96	LPCM 7.1@96
LPCM 2.0@192	LPCM 5.1@192	LPCM 7.1@192

8.3.3 Compressed Audio

Bitstreams
Standard Bitstream Formats
High-Bandwidth Bitstream Formats

Notes: Audio break away function supported in LPCM format only. The OAR, optical, and coaxial functions only support LPCM.

8.3.4 Audio Adjustments

- **Volume:** -100dB to 0dB and adjust 0.5dB per step (for both zone and extended audio).
- **Treble/Bass :** Bass range from - 12dB to +12dB, 1dB per step adjustment. Treble range from - 12dB to +12dB, 1dB per step adjustment.
- **Audio Delay:** 230ms for line-out per channel, 1ms per step adjustment.



8.4 Category Cable Specifications

Cable Type	Cable Length	Supported Video Format
Cat.5e/6	100 meters	Most common Full HD video: <ul style="list-style-type: none">• Up to 1080p@60Hz, 36-bit color• Data rates lower than 5.3Gbps or below 225MHz TMDS clock
	70 meters	Full HD & Ultra HD video: <ul style="list-style-type: none">• 1080p@60Hz, 48-bit color• 4K@24/25/30Hz, 24-bit color
Cat.6a/7	100 meters	<ul style="list-style-type: none">• Data rates higher than 5.3Gbps or above 225MHz TMDS clock

8.5 HDBaseT Features

HDBaseT Feature	Support
HD Video & Audio	✓
IR Control	✓
RS-232 Control	✓
Power to Compatible Receiver	✓
LAN	✓

9. ACRONYMS

ACRONYM	COMPLETE TERM
Cat.5e	Category 5 (enhanced) Cable
Cat.6	Category 6 Cable
Cat.7	Category 7 Cable
CLI	Command Line Interface
DVI	Digital Visual Interface
EDID	Extended Display Identification Data
GUI	Graphical User Interface
HD	High-Definition
HDCP	High-bandwidth Digital Content Protection
HDMI	High-Definition Multimedia Interface
HDR	High Dynamic Range
HTTP	HyperText Transfer Protocol
IP	Internet Protocol
IR	Infrared
LAN	Local Area Network
LPCM	Linear Pulse-Code Modulation
OLED	Organic Light-Emitting Diode
PC	Personal Computer
PCM	Pulse-Code Modulation
PoC	Power over Cable
PoH	Power over HDBaseT
S/PDIF	Sony/Philips Digital Interface Format
UHD	Ultra-High-Definition
USB	Universal Serial Bus
VGA	Video Graphics Array (640×480@60Hz)
WUXGA	Wide Ultra Extended Graphics Array (1920×1200@60Hz)



CYPRESS TECHNOLOGY CO., LTD.

www.cypress.com.tw

MPM-662CVEA