

Specifications

Nominal Voltage		12 V
Capacity (25°C)	20HR(10.5V)	2.8Ah
	10HR(10.5V)	2.6Ah
	1HR(9.60V)	1.82Ah
Dimension	Length	132 ± 1mm (5.20inch)
	Width	33 ± 1mm (1.30inch)
	Height	98 ± 1mm (3.86inch)
	Total Height	104 ± 1mm (4.09inch)
Approx. Weight		1.0kg (2.21lbs) ± 5%
Terminal type		T1
Internal resistance (Fully charged, 25°C)		Approx. 50mΩ
Capacity affected by temperature (20HR)	40°C	102%
	25°C	100%
	0°C	85%
	-15°C	65%
Self-discharge (25°C)	3 month	Remaining Capacity: 91%
	6 month	Remaining Capacity: 82%
	12 month	Remaining Capacity: 65%
Nominal operating temperature		25°C ± 3°C (77°F ± 5°F)
Operating temperature range	Discharge	-15°C ~ 50°C (5°F ~ 122°F)
	Charge	-10°C ~ 50°C (14°F ~ 122°F)
	Storage	-20°C ~ 50°C (-4°F ~ 122°F)
Float charging voltage(25°C)		13.60 to 13.80V Temperature compensation: -18mV/°C
Cyclic charging voltage(25°C)		14.50 to 14.90V Temperature compensation: -30mV/°C
Maximum charging current		0.84A
Terminal material		Copper
Maximum discharge current		42A(5 sec.)
Designed floating life(20°C)		10years

- ◆ Absorbent glass mat technology;
- ◆ Recognized by UL & CE;
- ◆ ABS container.

Constant Current Discharge Characteristics (A, 25°C)

F.V/TIME	5min	10min	15min	30min	60min	2h	3h	4h	5h	10h	20h
9.60V	10.6	6.72	5.32	2.97	1.82	0.99	0.71	0.57	0.49	0.26	0.14
9.90V	10.3	6.52	5.19	2.91	1.79	0.99	0.71	0.57	0.48	0.26	0.14
10.2V	9.90	6.25	5.00	2.82	1.75	0.98	0.70	0.56	0.48	0.26	0.14
10.5V	9.47	5.98	4.83	2.75	1.71	0.97	0.70	0.56	0.48	0.26	0.14
10.8V	8.94	5.64	4.58	2.65	1.66	0.94	0.68	0.54	0.46	0.26	0.14

Constant Power Discharge Characteristics (Watt, 25°C)

F.V/TIME	5min	10min	15min	30min	60min	2h	3h	4h	5h	10h	20h
9.60V	119	75.8	60.6	34.0	21.1	11.6	8.48	6.80	5.80	3.17	1.71
9.90V	115	73.5	59.2	33.3	20.8	11.6	8.43	6.76	5.76	3.16	1.70
10.2V	110	70.5	57.0	32.3	20.2	11.5	8.37	6.72	5.72	3.14	1.69
10.5V	106	67.5	55.1	31.5	19.8	11.3	8.32	6.67	5.68	3.12	1.68
10.8V	99.7	63.7	52.2	30.4	19.2	11.0	8.07	6.47	5.51	3.06	1.65

Note: The above characteristics data can be obtained within three charge/discharge cycles.

Dimensions

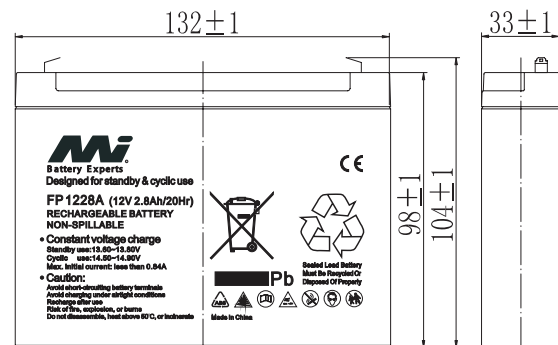

Terminal

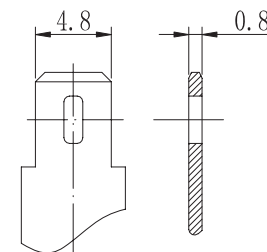

Terminal T1

Discharge Characteristics(25°C)

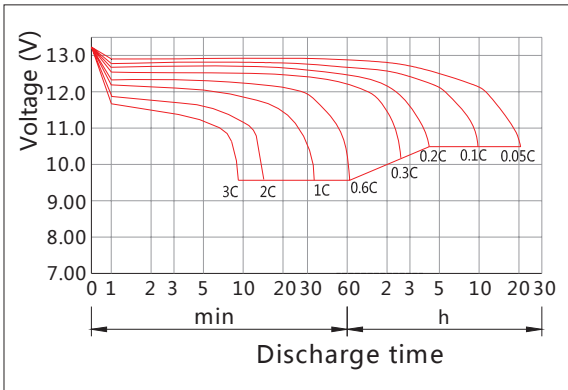

Charging Characteristics(25°C)

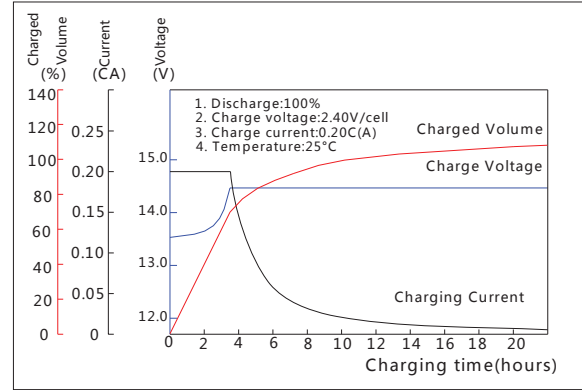

Effect of Temperature on Capacity

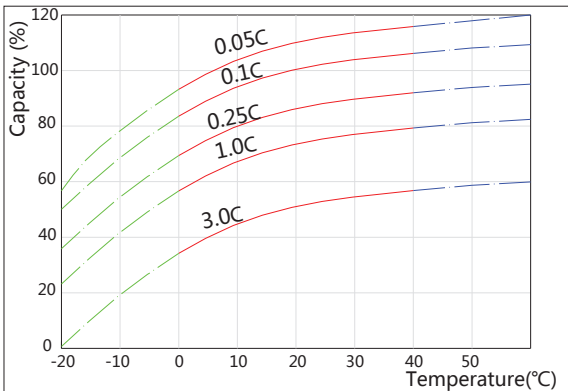

Self-discharge Characteristics

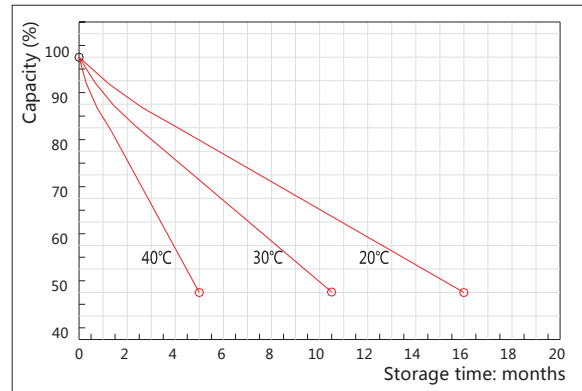

The Relationship for Open Circuit Voltage and Residual Capacity (25°C)

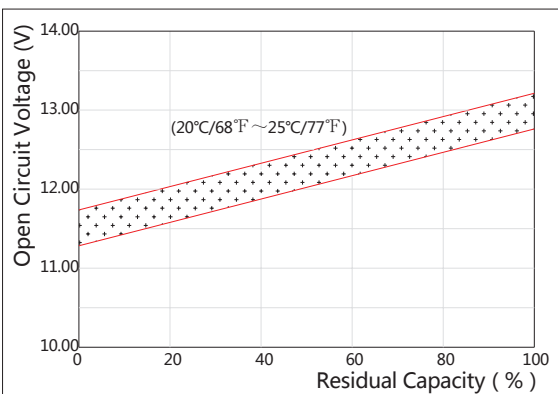

The Relationship for Charging Voltage and Temperature

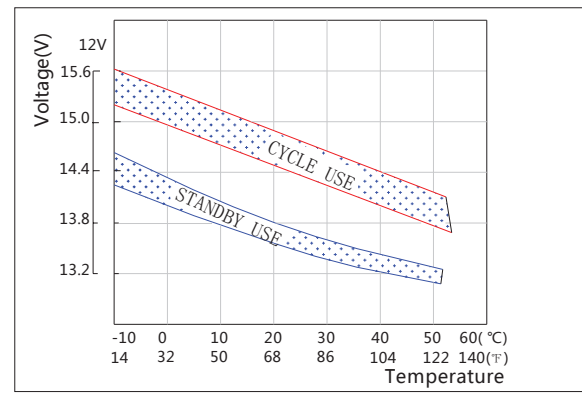

Floating Life on Temperature

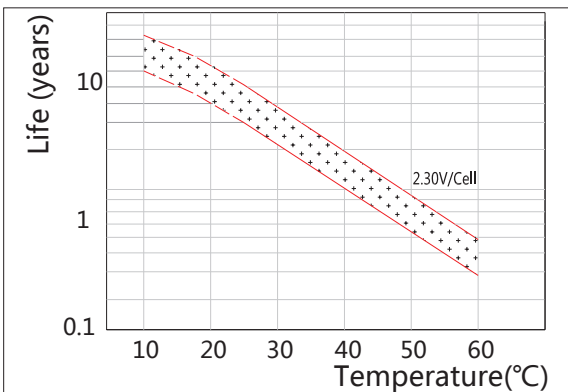

Cycle Life on D.O.D(25°C)

