

## GV-VD120D /121D / 122D / 123D 1.3MP H.264 Low Lux IR Vandal Proof IP Dome



- 1/3" progressive scan Low Lux CMOS
- Dual streams from H.264 and MJPEG
- Up to 30 fps at 1280 x 1024
- Vandal resistance (IK10 for GV-VD120D and GV-VD121D and IK7 for GV-122D and GV-VD123D)
- Ingress protection (IP67)
- Varifocal megapixel lens
- 3-axis mechanism (pan / tilt / roll)
- Removable IR-cut filter for Day/Night function
- External microphone
- Intelligent IR
- 2-way audio
- One sensor input and alarm output
- TV-out support
- Built-in micro SD card slot (SD/SDHC) for local storage
- [NAS](#) Recording
- Recording assigned by GV-Edge Recording Manager ([Windows](#), [Mac](#) version)
- DC 12V / AC 24V / PoE (IEEE 802.3af)
- Wide Dynamic Range (WDR)
- 2D noise reduction
- Defog
- Motion detection
- Tampering alarm
- Privacy mask
- IP address filtering
- Supports iPhone, iPad, Android & 3GPP
- 31 languages on Web interface
- ONVIF (Profile S) conformant

\* No Memory card slot & local storage function for Argentina.

\* For optimal performance and compatibility, it is highly recommended to use a GV-NAS System.

### Models

Model	Housing Cover	
	Cover Color	Vandal Resistance
GV-VD120D	Transparent cover	IK10+
GV-VD121D	Smoked cover	IK10+
GV-VD122D	Transparent cover	IK7
GV-VD123D	Smoked cover	IK7

### Active Tampering Alarm

Tampered



Focus Change



Camera Shift

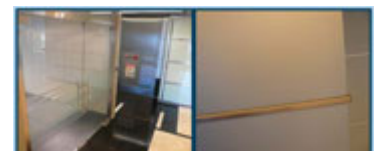

## Dimensions

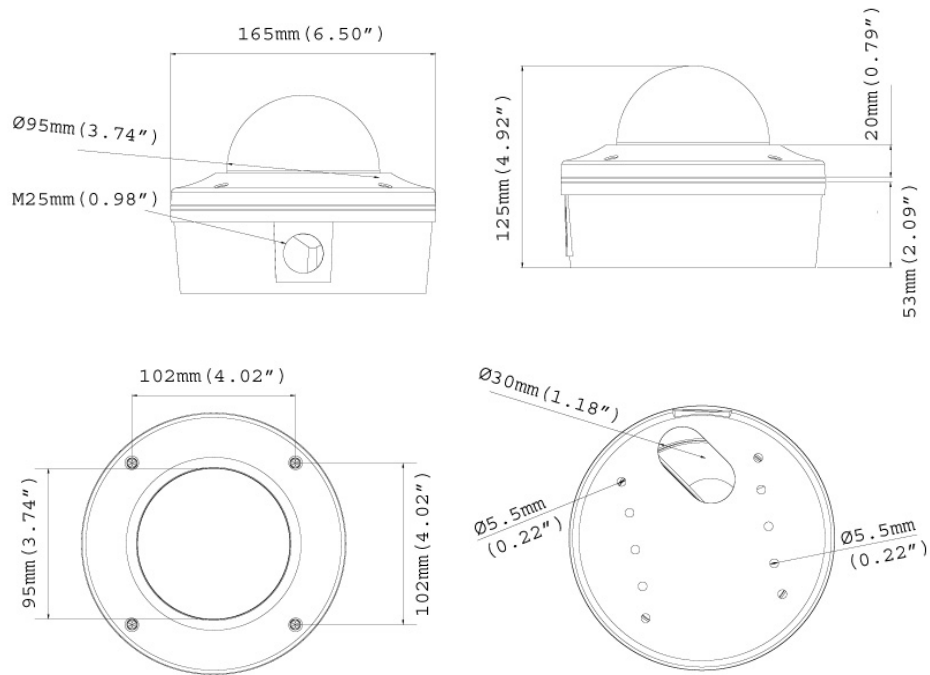

## Specifications

Camera		
Image Sensor	1/3" progressive scan CMOS	
Picture Elements	1280 (H) x 1024 (V)	
Minimum Illumination	Color	0.05 Lux
	B/W	0.03 Lux
	IR ON	0 Lux
Shutter Speed	Automatic, Manual (1/5 ~ 1/8000 sec.)	
White Balance	Automatic, Manual (2800K ~ 8500K)	
Gain Control	Automatic	
S/N Ratio	50 dB	
BLC	Yes	
Lens		
Megapixel	Yes	
Day / Night	Yes (with removable IR-cut filter)	
Lens Type	Varifocal	
Focal Length	3 ~ 9 mm	
Maximum Aperture	F/1.3	
Mount	Ø 14 mm	
Horizontal FOV	86°~32°	
Operation	Focus	Manual (w / lock)
	Zoom	Manual (w / lock)
	Iris	DC drive
Max. Torque (Focus/ Zoom Screws)	0.049 N.m	
IR LED Quantity	10 IR LEDs	
Max. IR Distance	15 m (50 ft.)	
Operation		
Video Compression	H.264, MJPEG	
Video Stream	Dual streams from H.264 and MJPEG	
Frame Rate	30 fps at 1280 x 1024	
	* The frame rate and the performance may vary depending on the number of connections and data bitrates (different scenes).	

Image Setting	Brightness, Contrast, Sharpness, Gamma, White Balance, Flicker-less, Image Orientation, Backlight Compensation, D/N Sensitivity, Shutter Speed, WDR, Defog, Denoise, Metering	
Audio Compression	G.711, AAC (optional)	
Audio Support	Two-way audio	
Sensor Input	1 Input (dry contact)	
Alarm Output	1 Output (200 mA 5V DC)	
<b>Video Resolution</b>		
Main Stream	4:3	1280 x 960, 640 x 480, 320 x 240
	16:9	1280 x 720, 640 x 360, 448 x 252
	5:4	1280 x 1024, 640 x 512, 320 x 256
Sub Stream	4:3	640 x 480, 320 x 240
	16:9	640 x 360, 448 x 252
	5:4	640 x 512, 320 x 256
<b>Network</b>		
Interface	10/100 Ethernet	
Ethernet Protocol	HTTP, HTTPS, TCP, UDP, SMTP, FTP, DHCP, NTP, UPnP, DynDNS, 3GPP/ISMA, RTSP, PSIA, SNMP, QoS (DSCP), ONVIF (Profile S)	
<b>Mechanical</b>		
Temperature Detector	Yes	
Camera Angle Adjustment	Pan	0° ~ 350°
	Tilt	10° ~ 90°
	Rotate	0° ~ 340°
Connectors	Power	2-pin terminal block, PoE
	Ethernet	RJ-45
	Audio	1 In (RCA female for microphone) 1 Out (RCA female for speaker)
	Digital I/O	I/O Wire
	Local Storage	Micro SD card slot (SD/SDHC, SD version 2.0 only, Class 10) * <b>SDXC</b> and <b>UHS-I</b> card types are not supported.
TV-Out	BNC connector (640 x 480 resolution)	
LED Indicator	2 LEDs: Power, Status	
<b>General</b>		
Environment Temperature	-30 °C ~ 50 °C (-22 °F ~ 122 °F)	
Humidity	10% to 90% (no condensation)	
Power Source	12V DC / 24V AC / PoE (IEEE 802.3af)	
Max. Power Consumption	12 W	
Dimensions	Camera Body	ø 165 x 125 mm (6.49" x 4.92")
	Cable Length	1 m (3.28 ft.)
	Cable Diameter	ø 16.7 mm (0.66")
	Maximum Connector Diameter	ø16.7 mm (0.66")
Weight	1.7 kg (3.75 lb)	
Ingress Protection	IP67	
Vandal Resistance	GV-120D / GV-121D	IK10+
	GV-122D / GV-123D	IK7
Regulatory	CE, FCC, RCM, RoHS compliant	
<b>Power over Ethernet</b>		
PoE Standard	PoE (IEEE 802.3af Power over Ethernet / PD)	
PoE Power Supply Type	End-Span	
PoE Power Output	Per Port 48V DC, 350 mA. Max. 15.4 watts	
<b>Web Interface</b>		
Installation Management	Web-based configuration	
Maintenance	Firmware upgrade through Web Browser or Utility	
Access from Web Browser	Camera Live View, Video Recording, Change Video Quality, Bandwidth Control, Image Snapshot, Digital I/O Control, Audio, Picture in Picture, Picture and Picture, Privacy Mask, Visual Automation, Tampering Alarm, Text Overlay, Digital PTZ	

Language	Arabic / Bulgarian / Czech / Danish / Dutch / English / Finnish / French / German / Greek / Hebrew / Hungarian / Indonesian / Italian / Japanese / Lithuanian / Norwegian / Persian / Polish / Portuguese / Romanian / Russian / Serbian / Simplified Chinese / Slovakian / Slovenian / Spanish / Swedish / Thai / Traditional Chinese / Turkish
<b>Applications</b>	
Network Storage	GV-System (GV-DVR/NVR), GV-Backup Center, GV-Recording Server, GV-VMS
Smart Device Access	GV-Eye for iOS and Android
Live Viewing	IE, mobile phone
CMS Server support	GV-Control Center, GV-Center V2, GV-Vital Sign Monitor

**Note:**

1. Do not use clothes or any ordinary material to clean the camera cover since they may result in scratches.
2. Specifications are subject to change without notice.
3. Mind the following when using a memory card for recording:
  - Recorded data on the memory card can be damaged or lost if the data are accessed while the camera is under physical shock, power interruption, memory card detachment or when the memory card reaches the end of its lifespan. No guarantee is provided for such causes.
  - The stored data can be lost if the memory card is not accessed for a long period of time. Back up your data periodically if you seldom access the memory card.
  - Memory cards are expendable and their durability varies according to the conditions of the installed site and how they are used. Back up your data regularly and replace the memory card annually.
  - To avoid power outage, it is highly suggested to apply a battery backup (UPS).
  - For better performance, it is highly suggested to use Micro SD card of MLC NAND flash, Class 10.
  - Replace the memory card when its read/write speed is lower than 6 MB/s or when the memory card is frequently undetected by the camera.







**Packing List**

- |                         |   |
|-------------------------|---|
| 1. Vandal Proof IP Dome | 10. Plastic Clip x 3                                    |
| 2. Silica Gel Bag x 2   | 11. Focus Adjustment Cap                                |
| 3. Screw Anchor x 4     | 12. 2-Pin Terminal Block                                |
| 4. Torx Wrench x 1      | 13. Power Adapter                                       |
| 5. Ceiling Screw x 4    | 14. GV-IPCAM H.264 Software DVD                         |
| 6. Blue Screw x 3       | 15. GV-NVR Software DVD                                 |
| 7. T-Cap Screw x 3      | 16. GV-Vandal Proof IP Dome Hardware Installation Guide |
| 8. Small Screw Cap x 3  | 17. Warranty Card                                       |
| 9. T-Cap x 3            |   |

**Note:** The power adapter can be excluded upon request.

## Accessories

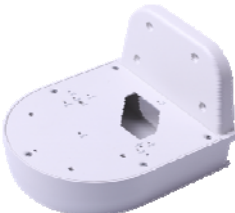
Model No.	Name		Details
GV-Mount100	Straight Tube and Junction Box Kit		Dimensions: 200 x 170 x 257.5 mm (7.9" x 6.7" x 10.1") Weight: 3.17 kg (6.99 lb)
GV-Mount101	Straight Tube Kit		Dimensions: 219 x 125 x 332 mm (8.6" x 4.9" x 13.1") Weight: 1.8 kg (3.97 lb)
GV-Mount200	Wall Pendant Tube		Dimensions: 225 x 140 x 250 mm (8.9" x 5.5" x 9.8") Weight: 900 g (1.98 lb)
GV-Mount203	Wall Pendant Tube and Junction Box Kit		Dimensions: 315 x 195.5 x 225 mm (12.4" x 7.7" x 8.9") Weight: 2.95 kg (6.5 lb)
GV-Mount205	Wall Mount Bracket Kit		Dimensions: 126.5 x 203 x 160 mm / 5 x 8 x 6.3" (L x W x diameter) Weight: 0.5 kg / 1.1 lb
GV-Mount300	Convex Corner Adapter Kit		Dimensions: 238.6 x 409.5 mm (9.4" x 16.1") Weight: 4.27 kg (9.41 lb)
GV-Mount310	Concave Corner Adapter Kit		Dimensions: 238.6 x 409.5 mm (9.4" x 16.1") Weight: 4.27 kg (9.41 lb)
GV-Mount400	Pole Mount Bracket Kit ( $\varnothing$ 4" ~ 6")		Bracket: 241 x 161 mm (9.5" x 6.3") Weight: 1.70 kg (3.75 lb) Steel Strap Diameter: $\varnothing$ 4" ~ 6"

Model No.	Name		Details
GV-Mount410	Pole Mount Bracket Kit (Ø 6" ~ 7.5")		Bracket: 241 x 161 mm (9.5" x 6.3") Weight: 1.70 kg (3.75 lb) Steel Strap Diameter: Ø 6" ~ 7.5"
GV-Mount702	Extension Tube		Four options are available. Dimensions: Ø 5.4 x 10 or 20 or 30 or 50 cm (Ø 2.1" x 3.9" or 7.9" or 11.8" or 19.7") Weight: 180 g or 390 g or 550 g or 800 g (0.4 lb or 0.86 lb or 1.21lb or 1.76 lb)
GV-Mount900	Wall Mount Bracket		Dimensions: 154 x 108 x 50 mm (6.1" x 4.3" x 2") Weight: 240 g (0.53 lb)
GV-Mount901	GV-VD Series Dome Housing		Dimensions: Ø 186 x 97.5 mm (Ø 7.3" x 3.8") Weight: 600 g (1.32 lb)
GV-Mount909	Wall Mount Bracket		Dimensions: 170 x 150 x 110 mm (6.7" x 5.9" x 4.3") Weight: 610 g (1.34 lb)
GV-PA191	Power over Ethernet (PoE) Adapter		The GV-PA191 is a Power over Ethernet (PoE) adapter designed to provide power to the IP device through a single Ethernet cable.
GV-Relay V2	GV-Relay V2		The GV-Relay V2 is designed to expand the voltage load of GV IP devices. It provides 4 relay outputs, and each can be set as normally open (NO) or normally closed (NC) independently as per your requirement.
Power Adapter	Contact your sales representative for the countries and areas supported.		
GV-POE Switch	The GV-POE Switch is designed to provide power along with network connection for IP devices. The GV-POE Switch is available in various models with different numbers and types of ports.		