

Technical Guide

Microwave Ovens with Inverters



Panasonic Services Company
National Training

Objective

The objective of this course is to provide the student with information about the latest technology used in Panasonic's new line of microwave ovens.

Upon successful completion of this course, the student will learn the differences between the high voltage circuit used in most microwave ovens, and the Inverter technology used in this line of Panasonic microwave ovens.

The student will also have a better understanding of the new features and the function of the major components of the microwave oven.

Table Of Contents

Microwave	1
What are Microwaves?	1
How do microwaves cook?	1
Inverter Technology.....	2
Difference Between MWO without Inverter and MWO with Inverter	2
Major components.....	4
Magnetron	4
How to diagnose for an open filament or a shorted magnetron	4
Oven cavity	5
Turntable	5
Primary/secondary latch switches	6
Short switch.....	6
Temperature Sensors.....	8
Steam Sensor.....	9
How to check the steam-sensor function.....	10
Inverter Circuit.....	11
Test and Measuring Procedures.....	15
Procedure to check the Inverter using an Amp. Meter	15
Measurement of microwave output	16
Procedure for measuring microwave energy leakage	17
Safety Tips.....	19
Safety tips for operation of microwave ovens.....	19
Safety tips for installation and maintenance of microwave ovens.....	19
Models line-up	20
Features.....	21
Functions.....	27
Understanding Ionizing & Non-Ionizing Radiation.....	29
Troubleshooting.....	31
Inverter Circuit and Magnetron Troubleshooting	33
Glossary of Electronic & Microwave Oven Related Terms	34

Microwave

What are Microwaves?

Microwaves, like visible light, are a part of the electromagnetic radiation spectrum. They are extremely high frequency radio waves. As the frequency of radiation increases, its wavelength decreases. The very high frequencies correspond to very short wavelengths; hence the name microwaves. Infrared radiation, ultraviolet light and X-rays are also electromagnetic radiations, but have even shorter wavelengths than microwaves.

Microwaves absorption and reflectivity are functions of the matter subjected to them. Metallic surfaces are good reflectors of microwaves. However, electrically non-conductive materials allow microwave to pass through them with very little absorption. All other materials that fall between metals and electrical isolators absorb microwave at different rates. Materials containing moisture, such as food and even people, absorb microwave energy. If energy is absorbed at a rate greater than the rate at which the material loses energy (rate of cooling), its temperature increases.

How do microwaves cook?

In microwave ovens, magnetrons are used to produce the microwaves. These microwaves have a frequency of 2,450 MHz, which is transmitted into the enclosed metal oven cavity. In the cavity, they are reflected by the oven walls and absorbed in food or drink placed in the oven.

Microwaves continuously reverse the polarity of the food molecules a tremendous number of times (2,450,000,000 times per second). This causes molecular agitation and thus friction, which produces heat and results in a rapid rise in temperature. Cooking time is usually much shorter than in a conventional oven.

The rate of heating depends on the type of food, its shape, volume, and mass.

The oven walls are not directly heated by microwaves, as they do not absorb microwave energy. However, the inside of the oven may feel warm due to the presence of the hot food and the heat generated by the electrical circuits.

Inverter Technology

Panasonic uses proprietary Inverter technology in most of its microwave ovens.

Difference Between Traditional and Inverter Microwave Ovens

Traditional microwave ovens

Conventional microwave ovens use power transformers to increase the household line voltage (120 VAC at 60 Hz) to a level high enough to operate the magnetron. The magnetron generates the microwaves that cook the food. This technique has its drawbacks.

Operating at a low frequency of 60 Hz, the transformer is relatively inefficient:

- Power is lost (through heat dissipation) in converting the line voltage to the higher magnetron level.
- The transformer operates at a constant power (cooking level) that can only be changed by switching the power on or off repeatedly.

Inverter Technology

In inverter-equipped microwave ovens, the power transformer is replaced by a circuit board, which converts the 60Hz incoming line frequency to a variable rate of 20 KHz to 45 KHz. A relatively small transformer is then required to increase the voltage to the level required by a magnetron.

By varying the pulse width, the output power can be linearly controlled for more precise cooking and defrosting levels. The bulky power transformer is replaced by a small, lightweight circuit board; and, because less heat is dissipated, power efficiency is increased.

Conventional technology uses just a single power level, which is regulated by switching pulses. In contrast, inverter technology directly controls the power output. This constant soft penetration of microwave energy prevents the common problems of shrinkage, overcooking, and loss of nutrients. The result is even food temperature and textures throughout.

Power Level Comparison

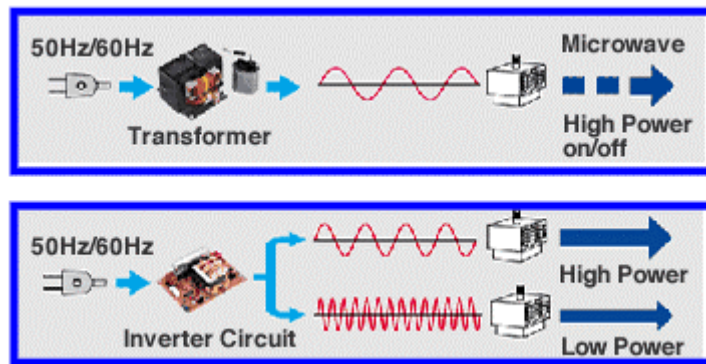

Figure 1

Traditional microwaves send out a single level of power in small bursts to cook food at different speeds. For example, when set at 60% power, the microwave energy would be on 60% of the time and idle 40% of the time.

Inverter microwaves, however, give accurate, true multiple power levels. When you ask for 60% power, the oven delivers 60% power (e.g. they don't just operate 60% of the time). This applies no matter what power level is selected. True power levels give you better cooking results and your food would have an even texture and temperature after cooking. The constant soft penetration of microwave energy into the center of the food helps prevent overcooking on edges and surfaces.

Difference Between Pulsing and Linear Power Control

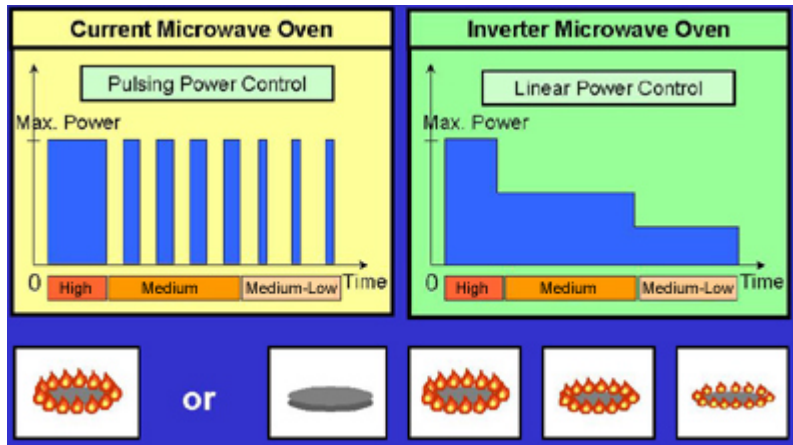

Figure 2

Major components.

Magnetron

In a microwave oven, the **magnetron** is used to produce the high frequency required for cooking. The frequency of microwaves for general cooking is 2,450MHz.

Magnetron components

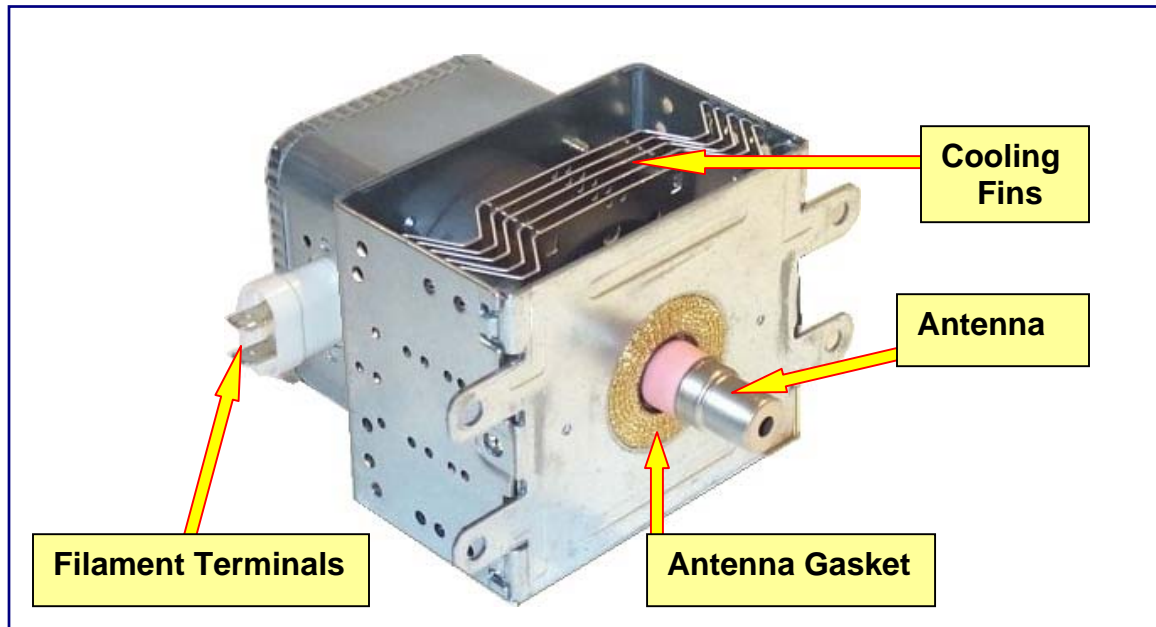

Figure 3

How to diagnose for an open filament or a shorted magnetron

To check for open filament:

- Disconnect the filament leads.
- Measure the resistance across the filament terminals. The normal resistance is approximately 1 ohm or less.

To check for a shorted magnetron:

- Disconnect the filament leads.
- Measure the resistance between each filament terminal and the magnetron case. Normally it should read open.

Note:

Do not rely on continuity check alone to determine if a magnetron is defective. Normal continuity reading can be obtained from a magnetron that is defective.

Whenever you replace the magnetron, measure for radiation leakage before the outer panel is installed and after all necessary components are replaced or adjusted.

Warning:

Special care should be taken in measuring around the magnetron. Avoid contact with any of the high voltage parts while conducting the radiation leakage test.

Oven cavity

The cavity is a multimode cavity resonator designed to resonate the microwaves emitted from the magnetron. Here is where the food is placed for cooking or heating. The oven cavity is made with stainless steel, aluminum, or painted steel plate to reflect the microwaves.

Oven Cavity

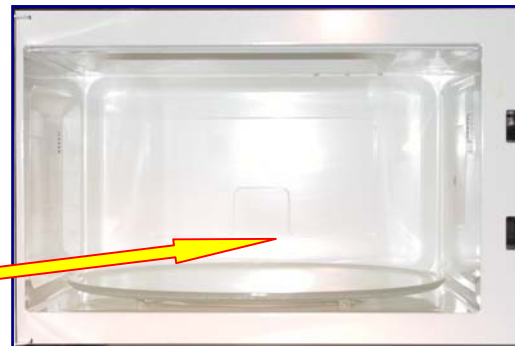

Figure 4

Turntable

The microwaves come into the oven's cavity from the side of the oven to ensure that the microwave field evenly covers the top, sides, and bottom of the food. The turntable then exposes all parts of the food to the field, for perfect results every time.

Turntable

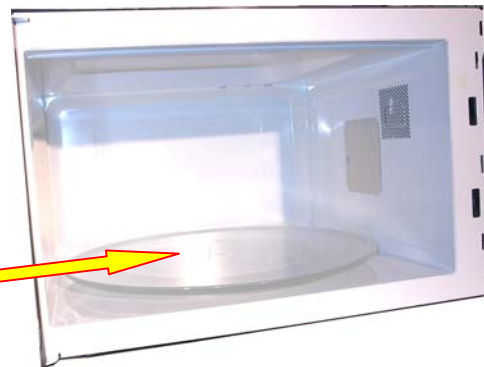

Figure 5

Primary / secondary latch switches

These are safety switches, and their basic function is to interrupt the power supply to the magnetron when the door starts to open. They are open when the door is opened.

	Switch position	
Switch	Door Opened	Door Closed
Primary	Open	Close
Secondary	Open	Close

Table 1

Short switch

This switch is used to prevent the operation of the microwave oven while the door is opened.

The short switch creates a short circuit to blow the line fuse and stop microwave oven's operation if the door switches fail to open when the door is opened.

This switch is normally open when the door is closed.

Switches Location

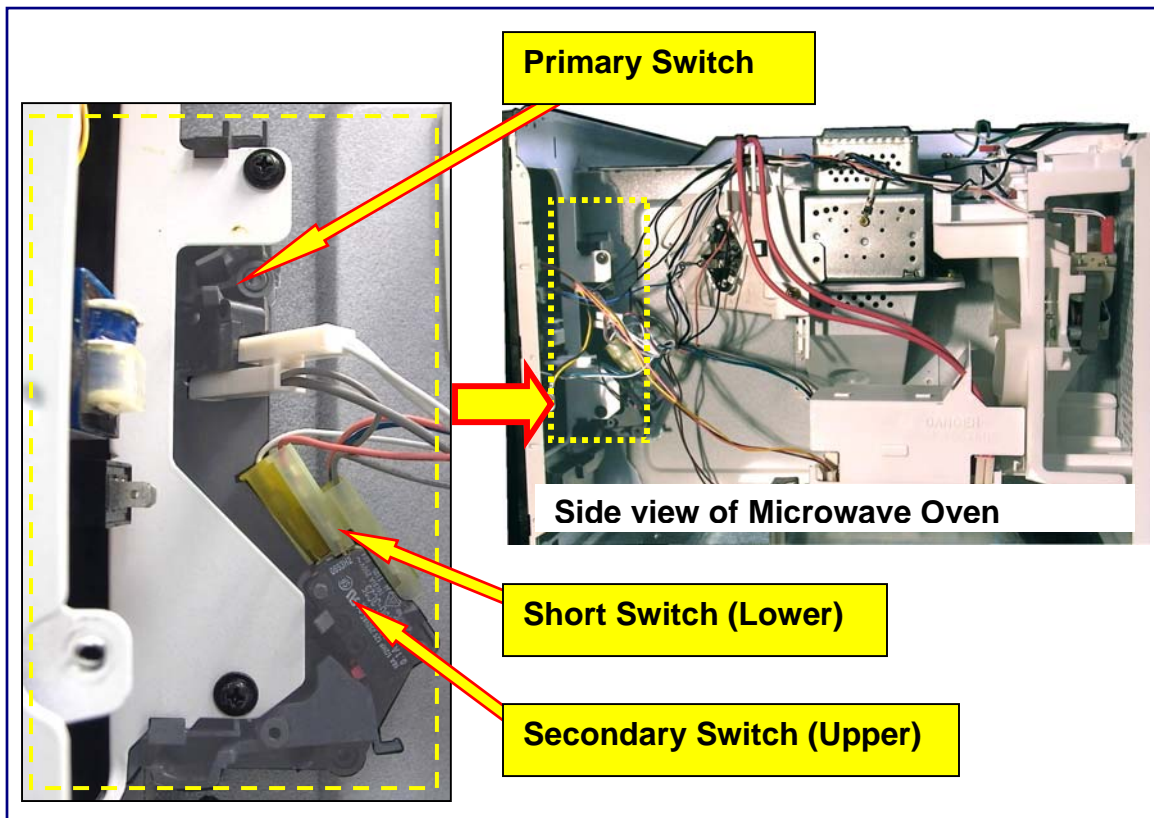

Figure 6

Note: When the fuse is blown due to operation of the short switch, replace the primary switch, the short switch, the secondary switch, and the power relay.

Adjustment of the primary latch switch, the secondary latch switch, and the short switch

1. Mount the primary latch switch, the secondary latch switch, and the short switch to the door hook assembly as shown in the figure 7.
NOTE: No specific individual adjustments during installation of the primary latch switch, secondary latch switch or short switch to the door hook are required.
2. When mounting the door hook assembly to the oven assembly, adjust the door hook assembly by moving it in the direction of the arrows in figure 7, so that the oven door will not have any play in it.
3. Check for play in the door by pulling the door assembly.
4. Make sure that the latch keys move smoothly after adjustment is completed. Tighten the screws holding the door hook assembly to the oven assembly.
5. Reconnect the short switch and check the continuity of the monitor circuit and all latch switches again by following the component test procedures.

Interlock switches

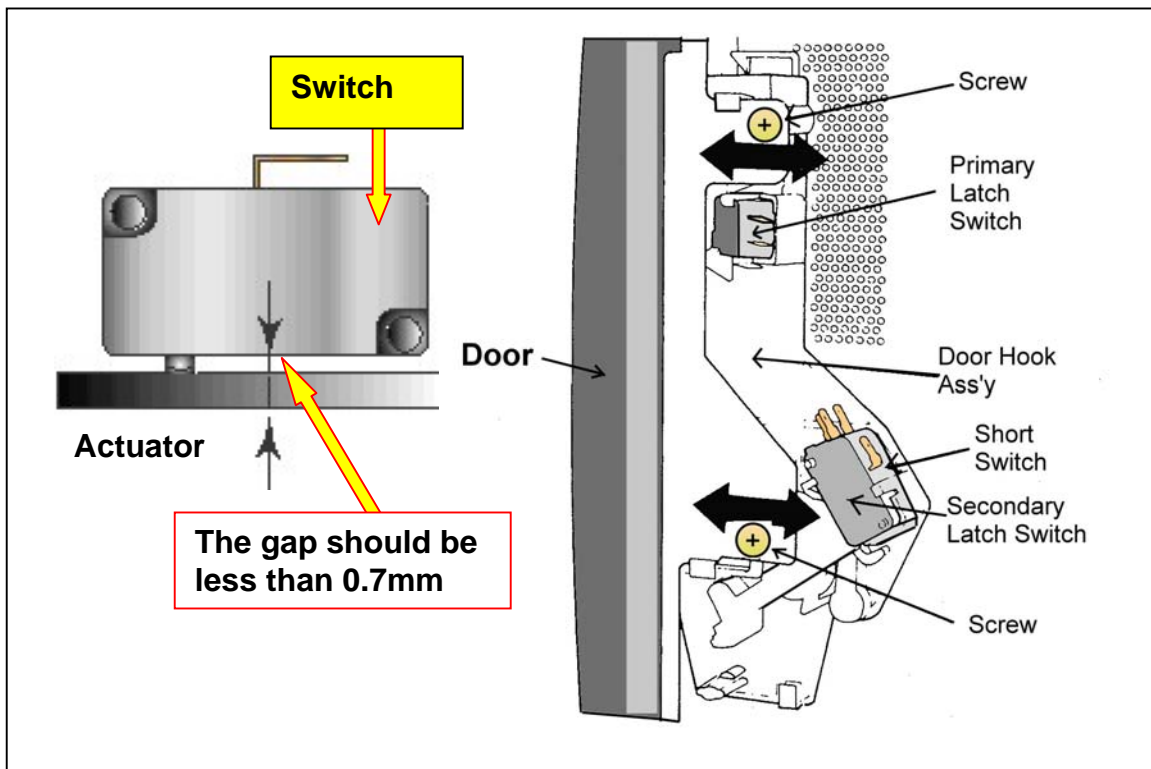

Figure 7

Temperature Sensors

This microwave oven uses 2 different types of temperature sensors. One is a thermal cutout sensor located on top of the oven cavity, and the other is a thermistor, which is mounted on the side of the magnetron. See Figure 8.

The thermal cutout sensor is used to stop the flow of AC to the oven, if the cavity surface overheats for any reason.

The thermistor will shut the oven down and reset the display when the magnetron overheats and reaches a temperature of 257° F.

The cooking program can be re-started after the magnetron cools down.

The value of this thermistor is 30K to 120K at 50°F ~ 86°F.

Temperature Sensors Location

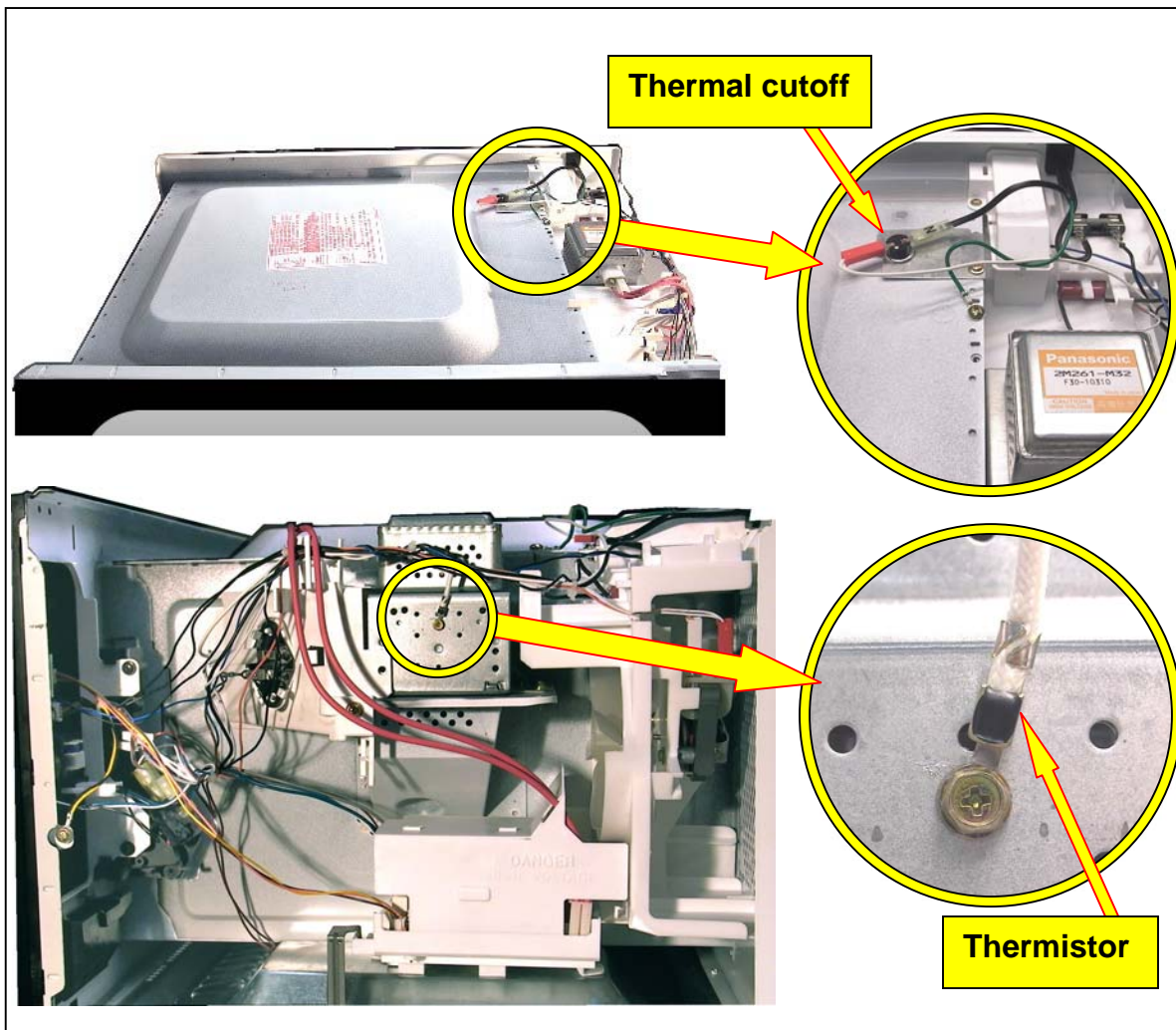

Figure 8

Steam Sensor

This sensor detects the presence of steam emitted by the food being heated and then, based on how long it took to reach the steam stage, it gauges how much longer it should cook, before shutting off.

The steam sensor works just like the effect called piezoelectricity. The piezoelectricity effect generates electricity when mechanical shock is applied to the general dielectrics material.

In the case of the steam sensor, this effect is called pyroelectricity, where electricity is generated when heat shock (hot steam) is applied to the general dielectrics material. See the figure below.

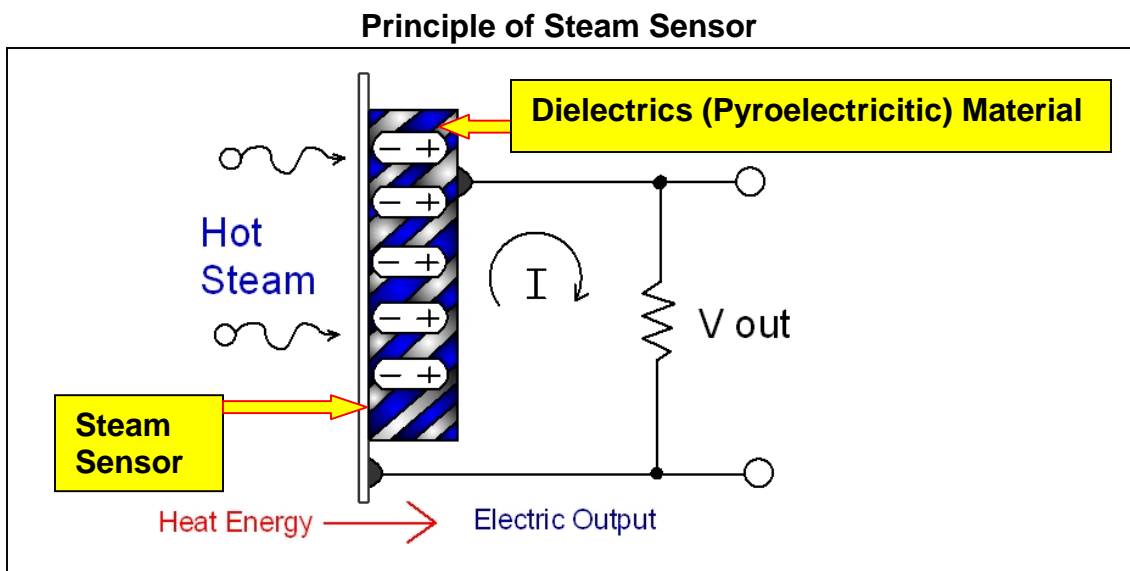

Figure 9

When the food is heated by the microwave oven, the food temperature gradually increases and steam is generated from the food. The steam sensor, which is located near the cooling fan, detects the steam from the food.

The fan keeps one side of the sensor cool and the other side, which has the element, receives and feels the hot steam from the oven cavity.

Steam Sensor Location



Figure 10

Side view of the microwave oven illustrating the steam operation

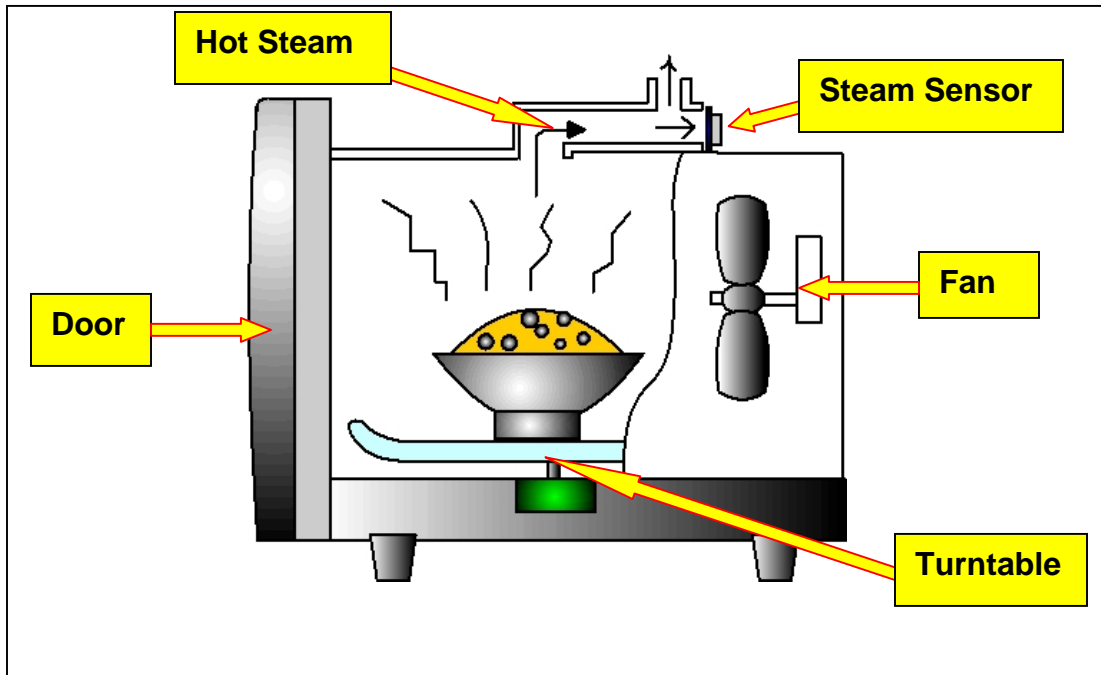

Figure 11

How to check the steam-sensor function.

To determine if this function is working ok, do the following:

1. Place a water load of 150 cc in the oven.
2. Press the sensor re-heat pad.
3. Press start.

Note: Steam is normally detected approximately 1.5 to 4 minutes after pressing power. This period is named “The detection period T1”. After going through this period, the unit automatically jumps to another period called “The remaining cooking time period T2”. The T2 time ranges from 8 seconds to 23 seconds.

4. “The steam sensor function” is normal, if after jumping to the T2 period, the “remaining cooking time” (8sec. ~ 23 sec.) appears in the display window.

Inverter Circuit

For information about the inverter power supply turn to pages 2 and 3.....

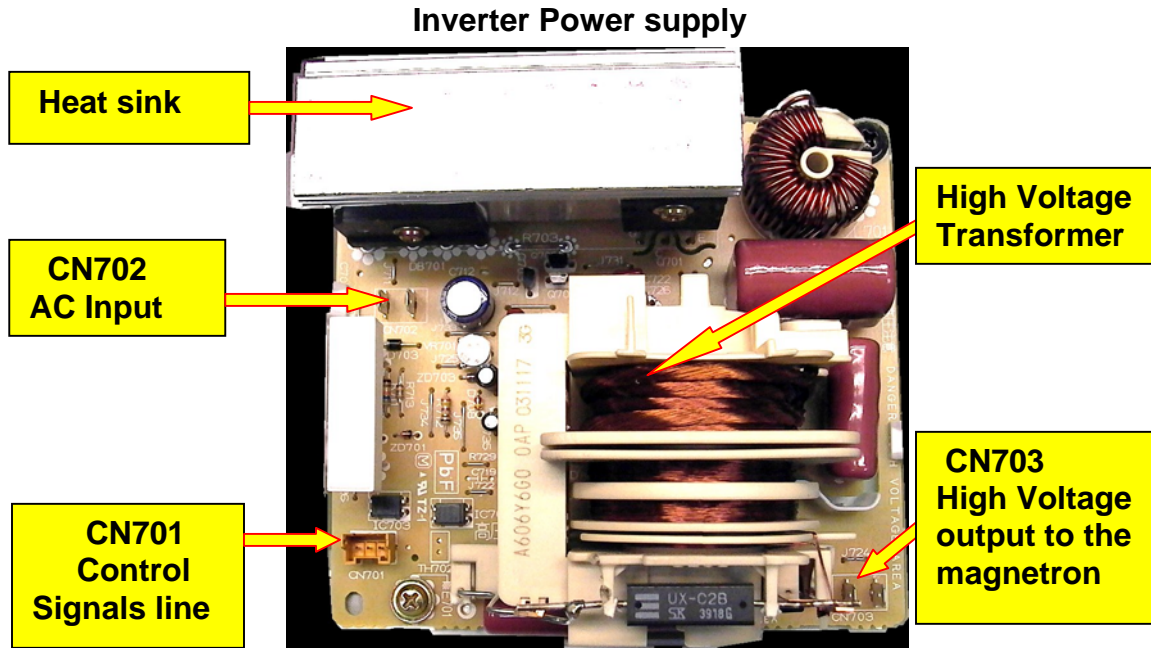

Figure 12

Inverter Power Supply Circuit Explanation

The inverter power supply circuit uses the AC line 120V, 60Hz to supply 4,000V DC to the magnetron tube.

The AC input voltage is rectified by the bridge rectifier DB701
DC voltage is applied to the Switching IGBT (Insulated Gate Bipolar Transistor) circuit.

Note: The **IGBT** is a cross between the bipolar and MOSFET transistors.

The high voltage transformer is driven by a PWM (Pulse Width Modulated) signal generated by the microprocessor in the DPC (Digital Programmer Circuit). The transformer is a component in the resonance circuit of the oscillator. Therefore, a change in load or the power level affects the frequency of the drive signal. Typically, the frequency ranges between 20KHz to 40KHz.

The high voltage transformer generates approximately 2,000V DC or more in the secondary winding and approximately 3V AC in the filament winding.

The half wave rectifier circuit, (D701, D702) generates the necessary 4,000V DC needed to drive the magnetron.

A signal from the current-sensing transformer CT701 in the inverter circuit is used to monitor the power output from the magnetron. This signal is applied to the microprocessor in the DPC to determine the working condition and the output necessary to control the PWM signal supplied to the inverter to control the power output.

Warning:

It's neither necessary nor advisable to attempt measurement of the high voltage.

Inverter Power Supply Circuit

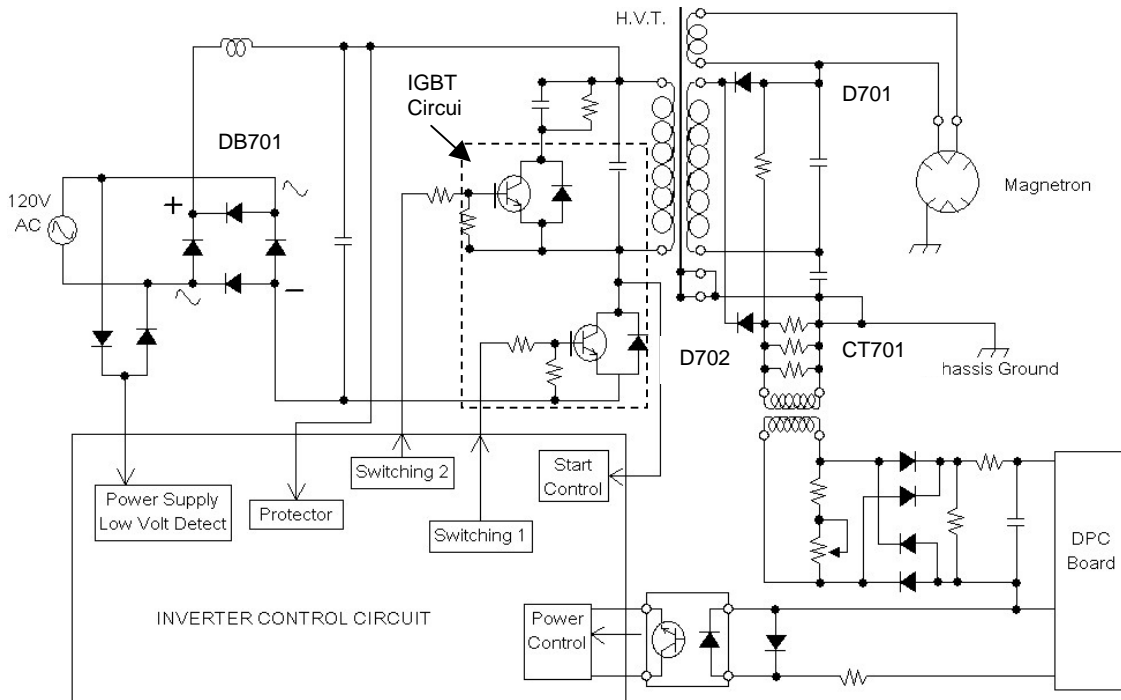

Figure 13

Warning

1. Always unplug the microwave oven from the electricity supply, before removing the outer panel.
2. Never touch the inverter PCB with the microwave oven plugged into the electricity supply. The inverter circuit board handles voltages up to 5000 volts and is very dangerous.
3. Do not touch the heat sink during operation of the microwave oven. The heat sink handles high voltage and becomes very hot.
4. Always discharge the high voltage capacitors located on the inverter circuit board before beginning any troubleshooting.
5. Only test the inverter circuit board by installing it completely into the oven and refitting the outer panel.
6. Always connect the inverter circuit to earth via the earth plate. It is very dangerous to operate the inverter circuit when it is not connected to earth.

Inverter Power Supply

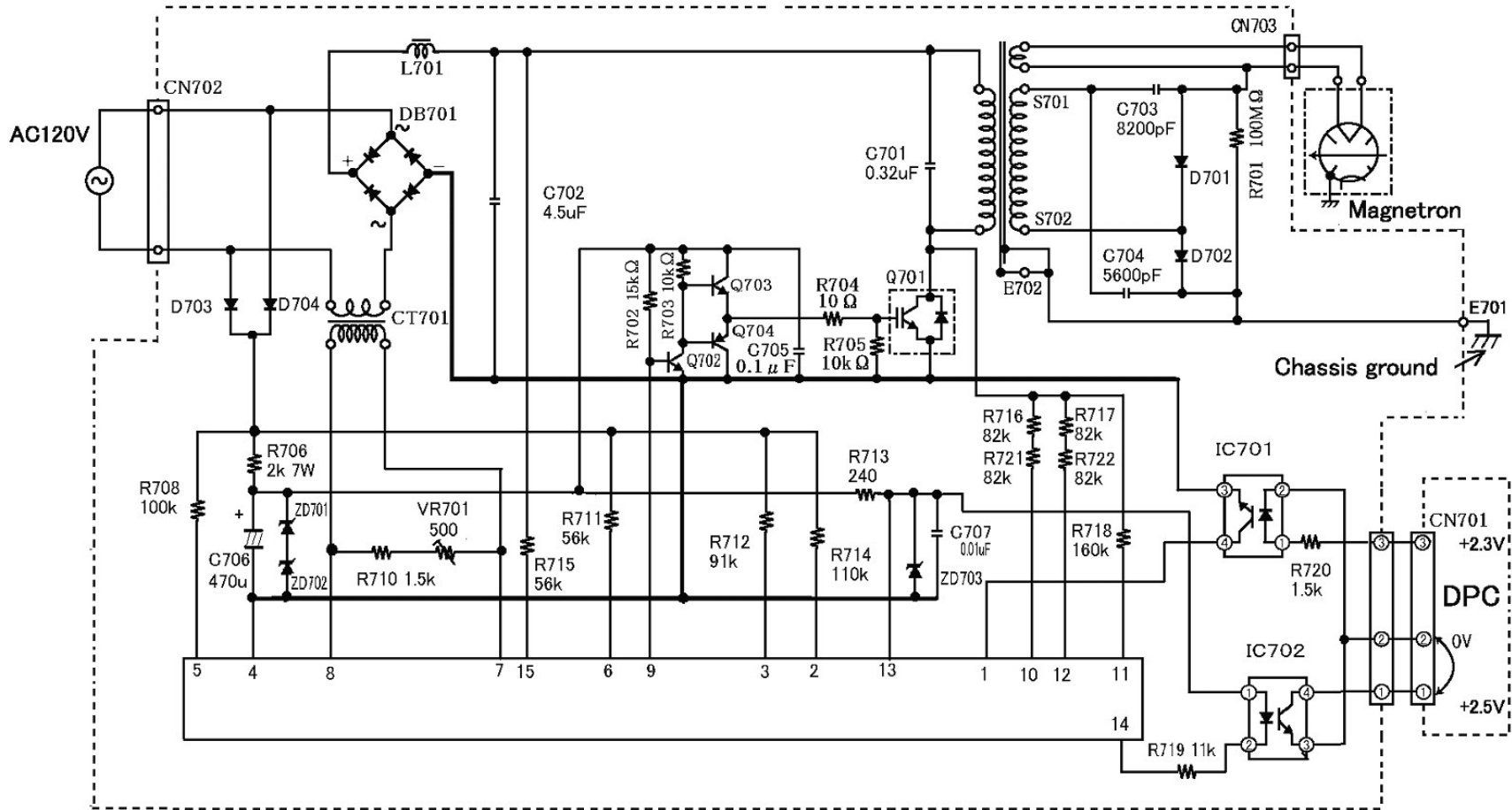

Figure 14

Test and Measuring Procedures

Procedure to check the Inverter using an Ammeter

Equipment needed:

1-liter beaker

An AC Ammeter.

1. Place the beaker with one liter of water into the oven cavity.
2. Unplug the 2 pins high voltage connector from the plug CN703 on the Inverter power supply.
3. Set the oven at high power for 1 minute and press start. The Oven operates for approximately 15 seconds and then it stops showing the error code **H98**.
During operation, the AC line current should be between 1A and 1.7A.
4. Unplug the 3 pins connector from CN701 on the inverter power supply.
5. Set the oven at high power for 1 minute and press start. The Oven operates for approximately 27seconds and then it stops showing the error code **H97**.
During operation, the AC line current should be between 0.4A and 0.8A.

Measurement of microwave output

The output power of the magnetron can be determined by performing IEC (International Electro-technical Commission) standard test procedures. However, due to the complexity of IEC test procedures, it is recommended to test the magnetron using the simple method outlined below.

Equipment necessary:

- 1 liter beaker.
- Glass thermometer.
- Stopwatch.



Figure 15

NOTE:

Check the line voltage under load. Low voltage will lower the magnetron output. Take the temperature readings and heating time as accurately as possible.

1 minute 1 liter test

Fill the beaker with exactly one liter of tap water. Stir the water using the thermometer and record the water's temperature.

1. Place the beaker on the center of glass tray.
2. Set the oven for High power and heat it for exactly one minute.
3. Stir the water again and read the temperature of the water.

The normal temperature rise at High power level for each model should be as follow:

- 1200W output (IEC705-88) models should have a minimum temperature rise of 18.5°F.
- 1300W output (IEC705-88) models should have a minimum temperature rise of 19.8°F.

Procedure for measuring microwave energy leakage

A radiation leakage test should be done every time the unit is repaired. If the result of the test registers a reading higher than $2\text{mW}/\text{cm}^2$, contact one of these companies, PASC, PSC, or PCI immediately.

The U.S. Government standard is $5\text{mW}/\text{cm}^2$ while in the customer's home. $2\text{mW}/\text{cm}^2$ stated here is our own voluntary standard. ($1\text{mW}/\text{cm}^2$ for Canada)

Equipment

- Electromagnetic radiation monitor
- Glass thermometer 212°F or 100°C
- 600cc glass beaker

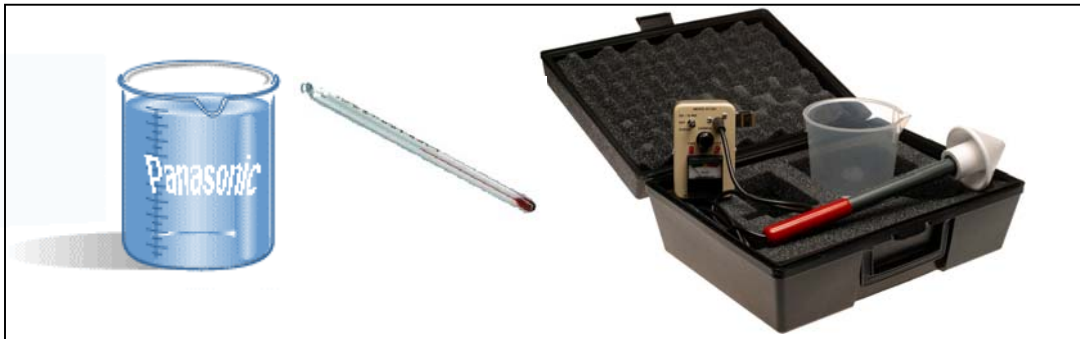

Figure 16

Procedure for measuring radiation leakage

1. Do not exceed the meter full-scale deflection. The leakage monitor should initially be set to the highest scale.
2. To prevent false readings, the test probe should be held by the grip portion of the handle only.
3. Pour $275 \pm 15\text{cc}$ ($9\text{Oz} \pm 1/2\text{oz}$) of $68^\circ \pm 9^\circ\text{F}$ water in a 600cc beaker and place in the center of the oven.
4. Set the radiation monitor to 2450MHz and use it following the manufacturer's recommended test procedure to assure correct results. When measuring the leakage, always use the 2" (5cm) spacer supplied with the probe.

5. Press the start pad or set the timer and with the magnetron oscillating, measure the leakage by holding the probe perpendicular to the surface being measured. Move it along the edges of the door, the display panel, and the cover at a very slow speed no faster than 1 inch/sec (2.5cm/sec).



Leakage reading for a fully assembled oven with door normally closed should be less than 2mW/cm^2 (1mW/cm^2 for Canada).

Leakage reading for a fully assembled oven [Before the latch switch (primary) is interrupted] while pulling the door should be less than 2mW/cm^2 .

Leakage reading for an oven with the outer panel removed should be less than 5mW/cm^2 .

Safety Tips

Safety tips for operation of microwave ovens

- Do not operate the oven when it is empty.
- Exercise extreme caution if you have a pacemaker implant. Microwave radiation may cause pacemaker interference.
- Persons with pacemaker implants should not be near a microwave oven unless they are sure that it is in good operating condition and there is no leakage of microwave radiation.
- Check to see that the door seal and inside surfaces of the door and oven cavity are clean after each use.
- Keep out of the reach of children. Do not permit young children to operate the oven.
- Do not put your face close to door window when oven is operating.

Safety tips for installation and maintenance of microwave ovens

- Take special care to ensure that no damage occurs to the part of the oven making contact with the door or door seals.
- Ensure that the microwave is unplugged or disconnected from electrical power before reaching into any accessible openings or attempting any repairs.
- Ensure that the adjustment of applied voltages, replacement of the microwave power generating component, dismantling of the oven components, and refitting of wave-guides are undertaken only by persons who have been specially trained for such tasks. The services of a qualified repairman should be sought when any malfunction is suspected.
- Do not bypass the door interlocks.
- Do not test the microwave power-generating component without an appropriate load connected to its output. The power generated must never be allowed to radiate freely into occupied areas.

Models line-up

Mid and Family-Size

NNS504W/M / NNS614W / NNH664B/W / NNH764B/W / NNT694S / NNP794B/W / NNP794S

Full-Size

NNH964B/W / NNP994B/W / NNP994S / NNS254W / NNH264B/W/Q / NNP294B/W /
NNP294S

Convection

NNC980W/B / NNC994S

Features

Note: Not all features apply to every model

Genius® Sensor Reheat and Cook

This feature applies to models NNH664B/W, NNH764W/B, NNP794B/W/S, NNP994B/W/S NNH964W/B, NNC980B/W, NNC994S, NNH264B/W/Q, NNH264S and NNT694S.

All 'Genius' microwaves also have the handy 'One Touch Sensor' function. As many as 24 different food types can be "sensor cooked".

At the touch of a single control, you are able to program the entire cooking cycle for popular foods such as chicken, vegetables, rice and fish. The sensor inside the microwave automatically cooks, defrosts and reheats food. It does all the thinking for you by adjusting cooking times and power levels automatically.

Two Level Cooking

With Panasonic's new 2 level cooking feature, your options are really stacking up. True 2 level cooking is now a reality using Inverter Technology from Panasonic. With the 2 level cooking rack you can prepare several dishes at once, at low to medium temperatures. Previous microwaves, unable to emit varying levels of power, produce uneven results when attempting to cook on 2 levels. But thanks to Inverter Technology, multiple food preparation is a possibility. Preparing food has never been this fast...or this easy.



Lightweight Design

Panasonic's Inverter® Microwave Ovens are lighter, sleeker and more compact than ever before, yet also offer more space inside to prepare food. Panasonic Inverter® technology replaces bulky capacitors with a compact circuit, reducing the weight and size of our microwave's power supply and providing more room in which to cook food. In all, an Inverter® Microwave Oven is 9 lbs. lighter than a conventional microwave oven.

"Keep Warm" Capability

Panasonic's "Keep Warm" Capability sets a new standard in cooking convenience, and is yet another added benefit of Inverter® technology. Delivering a steady, ultra low level of power, the "Keep Warm" feature maintains a food's warmth without overcooking, allowing you to store foods until they are ready to be served with a "fresh from the oven" taste.

You can keep stews, desserts, gravies or anything else fresh and warm in the microwave without further cooking them; impossible with a conventional microwave oven.

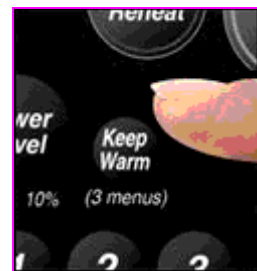

Button Panel

The new “Genius Prestige” ovens use an effortless-to-operate button panel. This panel makes it easier to select the desired settings. The Convection Oven has dials to control the oven’s temperature, time and weight.

Menu Action Screen

The Menu Action Screen display actually tells you what to do next. The words scroll across the screen, displaying the program you’ve selected and telling you the next step. It’s as easy as one touch on the appropriate pad and then following the simple instructions. There's even a multi-lingual display that easily guides you through cooking instructions in English, Spanish, or French. Food weight can be programmed for English or metric measurement.



Figure 17

Word Prompting.

The LCD screen provides word-by-word instructions on features such as setting the clock, Auto Defrost and using one-touch cooking. In total, there are over 50 instructions programmed into the oven, covering every feature of its operation.

Recipe Prompting.

At the touch of a single button, Recipe Prompting provides step-by-step instructions for a number of different recipes, advising on ingredients, cooking dishes needed, power levels and cooking time.

Versatile Function Key

The Function Key simplifies the programming of 10 useful non-cooking functions, such as the Child Lock. Just press the Function Key and the Menu Action Screen will display easy-to-follow steps to complete the desired action.

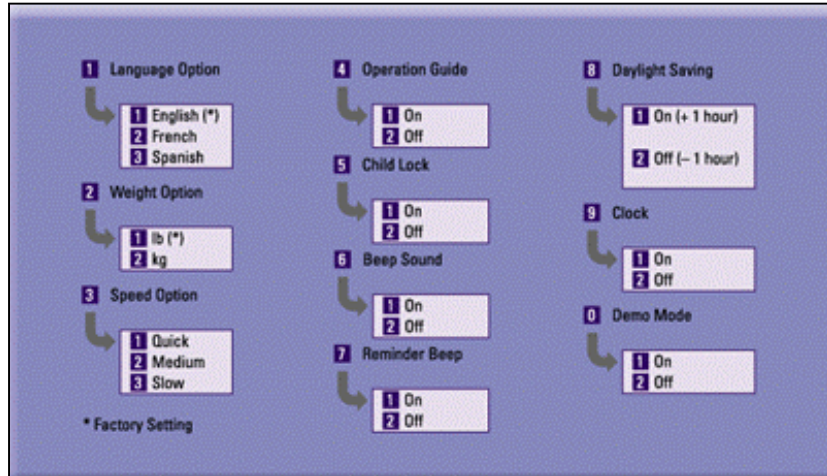
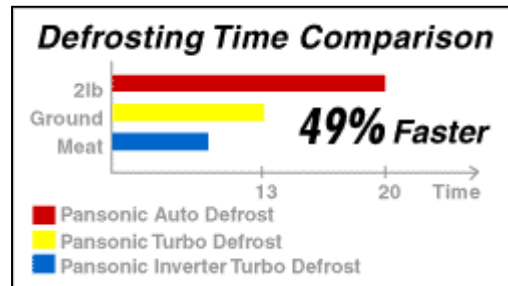

Figure 18

Non-Cooking Functions

Inverter Turbo Defrost

The Turbo Defrost™ feature allows you to defrost foods in almost half the time than previous Panasonic Auto Defrost. Panasonic Inverter Turbo Defrost technology is an advanced microwave sequencing system using the Inverter low-power delivery feature. It was developed on the basis of what scientists call "Chaos Theory." This design makes it possible to distribute microwave energy with the most appropriate combination of regularity and irregularity.



Defrosting Sequence Comparison

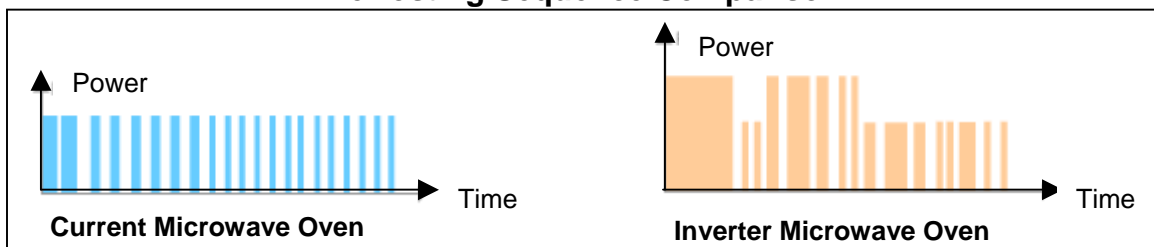

Figure 19

Fingerprint resistance Exterior (New Stainless Steel Models)

To help them stay clean for longer periods of time, the front panel has a special fingerprint resistant finish.

FutureWave Turntable System

Even microwave distribution means even cooking. Panasonic's FutureWave Turntable System makes it easy. The microwaves come from the side of the oven to ensure that the microwave field evenly covers the top, sides, and bottom of the food. The turntable then takes all parts of the food through that field, for perfect results every time.

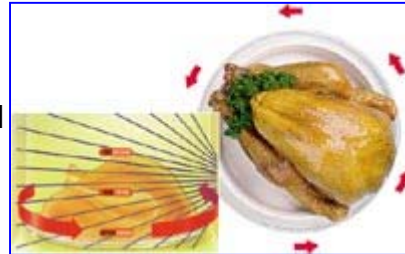

Movable Louvers (Over-the-Range models)

They open when needed for ventilation purposes when the oven's in use. However, when the cooking or defrosting task is complete, the louvers automatically close for a more streamlined appearance.

Dimension 4 Type

With this type of convection/microwave oven, besides having the advantage of a combination oven, it is also possible to bake, brown, re-heat and broil food.

Dimension 4 Type

<p>Bake Bake and brown with circulating heated air from 100°C to 230°C.</p>	<p>Combination The speed of microwave combines with the backing and browning of convection.</p>	<p>Microwave Defrost, cook or re-heat food in minutes.</p>	<p>Broiling Heat is quickly forced inside the food, sealing in juices and flavor.</p>
			

Table 1

Microwave Oven Built-in Trim Kit For kitchens with limited space.

Panasonic provides optional built-in trim kits which allow you to neatly and securely position a Panasonic microwave oven into an open area of your kitchen. Each kit includes all the necessary assembly pieces and hardware to give your Panasonic microwave oven a custom finish look.

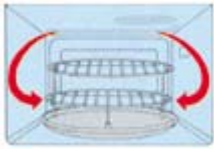
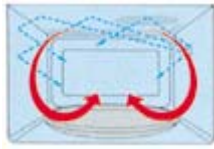
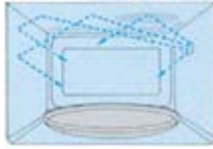
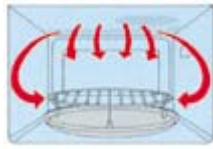

Figure 21

Use the table below to match the model numbers to their respective trim kit model number as well as the dimensions and required cabinet opening.

Microwave Oven Built-in Trim Kit For kitchens

Model Number	Trim Kit Model Number	Outside Dimensions of Installed Trim Kit	Cabinet Opening (W x H x D)
NNC980B / NNC980W*	NNTK909 NNTK909W*	67.5 cm x 49.6 cm (26 9/16 in. x 19 5/8 in.)	63.2 cm ± 0.16 cm x 45.9 cm ± 0.16 cm x 53.2 cm (minimum) (24 7/8 in. ± 1/16 in. x 18 1/6 in. ± 1/16 in. x 20 7/8 in. (minimum))
NNC994S**	NNTK903S** (27") NNTK913S** (30")	68.6 cm x 49.6 cm (27 in. x 19 1/2 in.) 76.2 cm x 49.6 cm (30 in. x 19 1/2 in.)	
NNT888S**	NNTK808S**	68.6 cm x 41.9 cm (27in. x 16 1/2 in.)	63.2 cm ± 0.16 cm x 38.8 cm ± 0.16 cm x 53.2 cm (minimum) (24 7/8 in. ± 1/16 in. x 15 5/6 in. ± 1/16 in. x 21 in. (minimum))
	NNTK818S**	76.2 cm x 41.9 cm (30 in. x 16 1/2 in.)	
NNP994S** NNP994W* / NNP994B NNH964B / NNH964W* NNS960B / NNS960W* NNS951B / NNS951W* NNT991S** NNS962B / NNS962W* NNS952B / NNS952W* NNS963B / NNS963W* NNS953W* / NNT993S**	NNTK929BR NNTK929WR* NNTK929S**	68.7 cm x 47.3 cm (27in. x 18 5/8 in.)	63.2 cm ± 0.16 cm x 44.2 cm ± 0.16 cm x 53.3 cm (minimum) (24 7/8 in. ± 1/16 in. x 17 3/8 in. ± 1/16 in. x 21 in. (minimum))
	NNTK939BR NNTK939WR* NNTK939S**	76.2 cm x 47.3 cm (30 in. x 18 5/8 in.)	
NNP794S** NNP794W* / NNP794B NNH764B / NNH764W* NNS760B / NNS760W* NNS751B / NNS751W* NNT790S** NNS762B / NNS762W* NNS752B / NNS752W* NNS763B / NNS763W* NNS753W* / NNT793S**	NNTK729B NNTK729W* NNTK729S**	68.7 cm x 41.9 cm (27 in. x 16 ½ in.)	63.2 cm ± 0.16 cm x 38.9 cm ± 0.16 cm x 53.3 cm (minimum) (24 7/8 in. ± 1/16 in. x 15 5/16 in. ± 1/16 in. x 21 in. (minimum))
	NNTK739B NNTK739W* NNTK739S**	76.2 cm x 41.9 cm (30 in. x 16 ½ in.)	
NNS512W* NNS562B / NNS562W* NNH664W* / NNH664B NNS563B / NNS563W* NNS513W* / NNS614W* / NNT583S** NNT694S**	NNTK529B NNTK529W* NNTK529S**	68.6 cm x 41.9 cm (27 in. x 16 ½ in.)	57.6 cm ± 0.16 cm x 38.9 cm ± 0.16 cm x 53.3 cm (minimum) (22 11/16 in. ± 1/16 in. x 15 5/16 in. ± 1/16 in. x 21 in. (minimum))

Table 2

Functions

2.0 Cubic Feet Oven Capacity

While conventional microwaves contain bulky transformers and large capacitors, the compact power-supply components of the Inverter circuit mean smaller exterior dimensions with a more spacious interior. Easier to clean and lightweight, the NN-S254BF over-the-range model features a 2.0 cubic foot oven cavity, which houses a large 12" turntable -- offering you the cooking capacity of a standard countertop microwave oven. Now you can have the space-saving advantage without giving up the roomy interior -- enough room to cook a large casserole, reheat a family-size portion of fried chicken, or even defrost an entire turkey.

1200 Watt High Power

Delivers faster cooking in a more compact microwave, with 1200W of high power in a model that's a fraction of the size of conventional 1200W microwaves.

Auto Cook Menu (15 Categories)

You'll have access to detailed menus that help make cooking with this Panasonic over-the-range microwave a simple task, even for the most novice chefs. Categories include oatmeal, beverages, bacon, soup, frozen entrees, frozen pizza, frozen pocket sandwiches, hot dogs, potatoes, vegetables (fresh or frozen), rice, frozen dinners, fish fillets and pasta.

Auto Reheat

Keep Warm/Simmer

A pulsing delivery of very low microwave power keeps food temperatures at a constant level -- without overcooking. Panasonic's improved keep warm menu now includes five items. So, foods like stew, gravy and desserts remain warm in the oven until you are ready to serve.

More/Less Control

This feature is useful when something needs to be cooked for a shorter or longer amount of time than the pre-programmed times.

Powerful 300 cfm Exhaust Fan with 3-Speed Ventilation

With three-speed operation, high, low and turbo, this fan is powerful enough to remove unwanted food odors from your kitchen, without the annoyance of excessive noise. The Turbo Fan setting, at an extremely fast speed of 300 CFM, refresh the air in your kitchen quickly and quietly.

Easy to Clean Outer Design

With no seams or breaks in the outer casing of the microwave oven, and no uneven edges and crevices on the underside of the cabinet, it's a cinch to wipe clean.

Delay Start/Timer

This feature allows you to program a set amount of time to let food stand after cooking. You can also program a delayed start (up to 99 minutes and 99 seconds) to the cooking. Finally, it allows you to use the microwave as a minute timer.

Multi-Lingual Menu Action Screen with Function Key

The Menu Action Screen is like having a gourmet chef to assist you in the kitchen. It scrolls step-by-step cooking instructions across the display in a choice of English, Spanish, or French. The Function Key simplifies the programming of 10 useful, non-cooking functions. Just press the Function Key and the Menu Action Screen will display easy-to-follow steps to complete the desired function.

Quick Minute

Set cooking times in one-minute intervals, or add a minute to a current cooking session.

Popcorn Button

Even though making popcorn is far from its only use, it's still a popular one. Three common sizes of microwave popcorn pouches are pre-programmed (1.75 oz., 3.0 oz., and 3.5 oz.). After selecting the appropriate size with the "Menu Action Screen", just push "Start". The oven will cook for the proper amount of time to ensure that most of kernels are popped.

Understanding Ionizing & Non-Ionizing Radiation

There is a distinction made between IONIZING radiation, which has enough energy to physically break chemical bonds at the molecular level, and NON-IONIZING radiation, which does not.

Radiation falls within a wide range of energies from the electromagnetic spectrum. The spectrum has two major divisions: non-ionizing and ionizing radiation.

Radiation that has enough energy to move atoms in a molecule around or cause them to vibrate, but not enough to change them chemically, is referred to as "**non-ionizing radiation.**" Examples of this kind of radiation are sound waves, visible light, and microwaves.

Radiation that falls within the "**ionizing radiation**" range has enough energy to actually break chemical bonds. This is the type of radiation that people usually think of as "radiation." We take advantage of its properties to generate electric power, to kill cancer cells, and in many manufacturing processes.

The energy of the radiation shown on the spectrum below increases from left to right as the frequency rises.

Types of Radiation in the Electromagnetic Spectrum

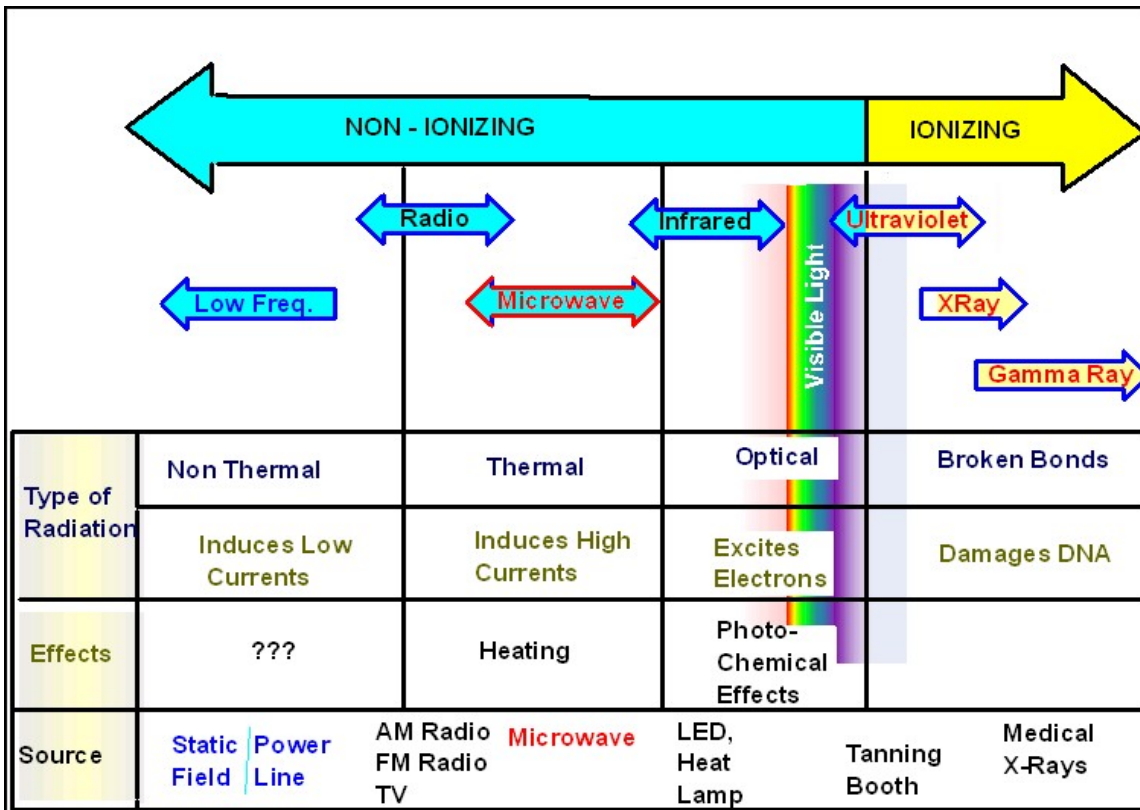

Figure 22

Non-ionizing Radiation

We take advantage of the properties of non-ionizing radiation for common tasks:

- microwave radiation: telecommunications and heating food
- infrared radiation: infrared lamps to keep food warm in restaurants
- radio waves: broadcasting

Non-ionizing radiation ranges from extremely low frequency radiation, shown on the far left through the audible, microwave, and visible portions of the spectrum into the ultraviolet range.

Extremely low-frequency radiation has very long wavelengths (on the order of a million meters or more) and frequencies in the range of 100 Hertz or cycles per second or less. Radio frequencies have wavelengths of between 1 and 100 meters and frequencies in the range of 1 million to 100 million Hertz.

Microwaves that we use to heat food have wavelengths that are about 1 hundredth of a meter long and have frequencies of about 2.5 billion Hertz.

Ionizing Radiation

Higher frequency ultraviolet radiation begins to have enough energy to break chemical bonds. X-ray and gamma ray radiation, which are at the upper end of magnetic radiation, have very high frequency --in the range of 100 billion billionth Hertz--and very short wavelengths--1 million millionth of a meter. Radiation in this range has extremely high energy. It has enough energy to strip off electrons or, in the case of very high-energy radiation, break up the nucleus of atoms.

Ionization is the process in which a charged portion of a molecule (usually an electron) is given enough energy to break away from the atom. This process results in the formation of two charged particles or ions: the molecule with a net positive charge, and the free electron with a negative charge.

Each ionization releases approximately 33 electron volts (eV) of energy. Material surrounding the atom absorbs the energy. Compared to other types of radiation that may be absorbed, ionizing radiation deposits a large amount of energy into a small area. In fact, the 33 eV from one ionization is more than enough energy to disrupt the chemical bond between two carbon atoms. All ionizing radiation is capable, directly or indirectly, of removing electrons from most molecules.

There are three main kinds of ionizing radiation:

- alpha particles, which include two protons and two neutrons;
- beta particles, which are essentially electrons; and
- gamma rays and x-rays, which are pure energy (photons).

Troubleshooting

Troubleshooting table

	Symptom	Cause	Corrections
1	Oven is dead. Fuse is ok. No display and no operation at all.	<ol style="list-style-type: none"> 1. Open or loose wire harness 2. Open Thermal cutout. 3. Open low voltage transformer. 4. Defective DPC 	Check the fan motor when the cutout is defective.
2	No display and no operation at all. Fuse is blown	<ol style="list-style-type: none"> 1. Shorted harness. 2. Defective primary switch 3. Defective the short switch. 4. Defective Inverter Power supply 	Check adjustments of primary switch, secondary switch, and short switch
3	The Oven does not accept key input (Program)	<ol style="list-style-type: none"> 1. Defective DPC 2. Open or loose connection of the membrane keypad. 3. Shorted or open membrane keyboard. 	
4	The Oven lamp and the fan motor turn on when oven is plugged in with door closed.	<ol style="list-style-type: none"> 1. Misadjusted secondary switch or loose wiring. 2. Defective secondary switch 	Adjust door and latch switches
5	Timer starts to countdown, but there's no microwave oscillation. (No heat while the oven lamp and the fan motor are on)	<ol style="list-style-type: none"> 1. Switches alignment is off 2. Open or loose connection of high voltage circuit, especially the magnetron filament circuit. 3. Defective Inverter 4. Defective magnetron 5. Open or loose wiring of power relay B. 6. Defective primary switch. 7. Defective power relay B or DPC 	Adjust door and latch switches. Check the Magnetron and the Inverter.

	Symptom	Cause	Corrections
6	The oven can be programmed, but the timer does not start to countdown.	<ol style="list-style-type: none"> 1. Open or loose wiring of secondary switch. 2. Secondary switch alignment is off. 3. Defective secondary switch 	Adjust door and latch switches
7	The microwave output is low. The oven takes too long to cook.	<ol style="list-style-type: none"> 1. Decrease in AC power source voltage. 2. Open or loose wiring of magnetron filament circuit. (Intermittent oscillation) 3. Aging change of magnetron. 	Check the outlet voltage. Perform microwave power output test.
8	The fan motor and the oven lamp turn on when the door is opened.	<ol style="list-style-type: none"> 1. Shorted primary switch. 	APH (USA) Models only
9	The oven does not operate. It returns to plugged-in mode as soon as the start pad is pressed.	<ol style="list-style-type: none"> 1. Open or loose wiring of temperature sensor. (Thermistor) 2. Defective temperature sensor (Thermistor) 3. Defective DPC. 	Check for tight contact of screw on thermistor, and check the connection on the DPC.
10	Loud buzzing noise can be heard.	<ol style="list-style-type: none"> 1. Loose fan. 2. Noisy fan 	
11	Turntable motor does not rotate.	<ol style="list-style-type: none"> 1. Open or loose wiring of turntable motor 2. Defective turntable motor 	
12	The Oven stops operation during cooking.	<ol style="list-style-type: none"> 1. Open or loose connection of primary and secondary switch 2. Operation of Thermal cutout (Thermistor) 	Adjust the door and the switches.
13	The oven returns to plugged-in mode after 10 seconds elapse on the Auto-sensor cooking mode.	<ol style="list-style-type: none"> 1. Open or loose wiring of sensor terminal from DPC 2. Open steam sensor. 3. Defective DPC. 	

Table 2

Inverter Circuit and Magnetron Troubleshooting

This microwave oven is programmed with a self-diagnostic failure code system used for troubleshooting.

The error codes H97, H98, and H99 are used to indicate problems related to the inverter circuit and the magnetron. These codes appear on the display window after the start key is pressed and there is no microwave oscillation.

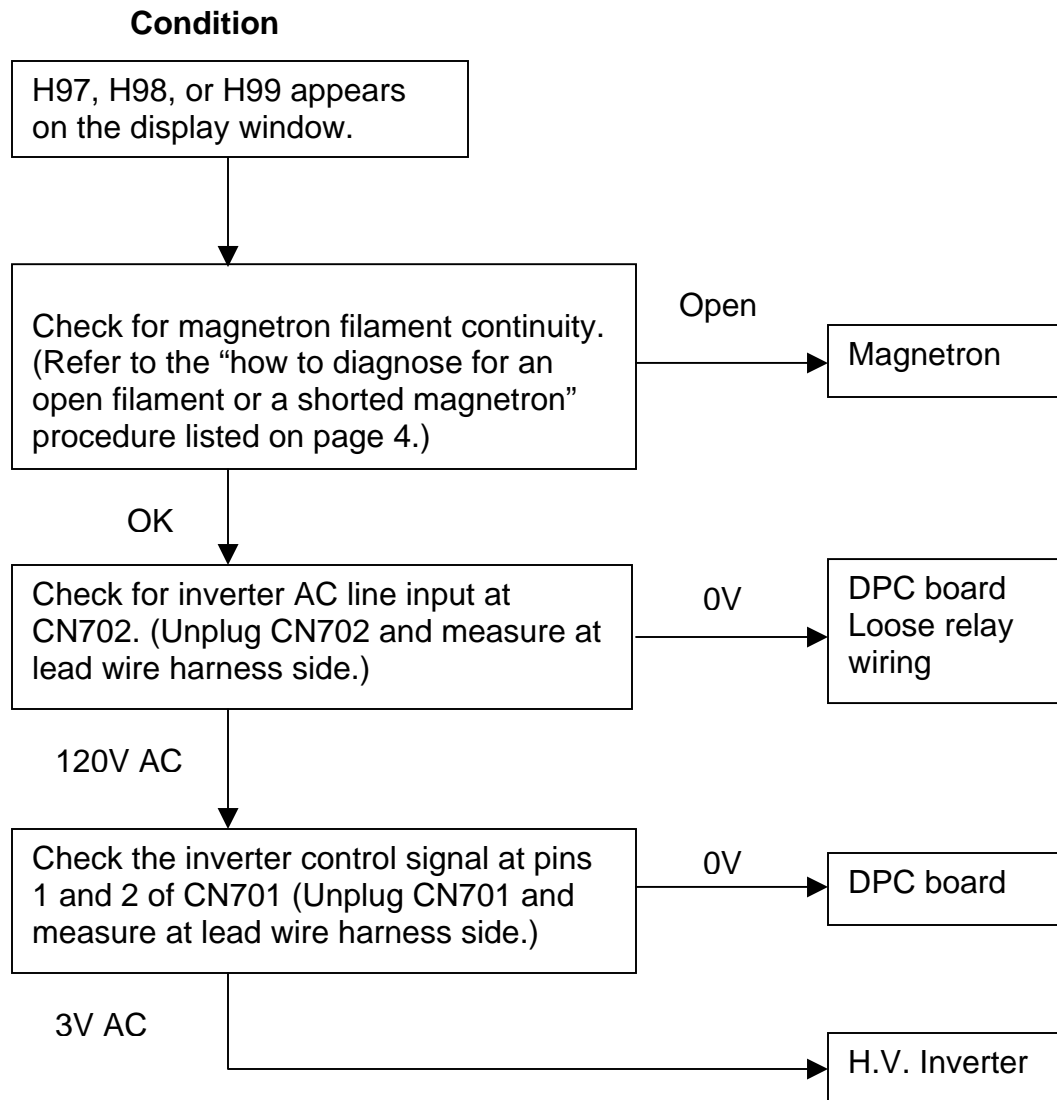

Note: Do not re-adjust preset volume, or try to repair this inverter power supply.

Glossary of Electronic & Microwave Oven Related Terms

AC VOLTAGE: An electric current that reverses its direction regularly and continually, thus it is Alternating Current.

AMPERAGE: The strength of an electric current measured in amperes. One ampere is the amount of current that flows through one ohm of resistance with one volt applied.

AMPLITUDE: The maximum instantaneous value of an alternating wave of voltage or current measured from a reference line to either a maximum positive value or maximum negative value.

ANALOG: A variable that remains similar to another variable in proportional relationships over a specified range.

ANODE: The positive electrode in an electrochemical device. In a magnetron tube, the anode is usually the outer casing and is at ground potential.

ANODIZE: A process that electrolytically produces an insulating oxide film on a conducting surface.

ANTENNA PIN: See tuning stub.

BIAS: A DC voltage applied to the control electrode of an electronic device to establish the desired operating point.

CAPACITANCE: The property of a capacitor that determines how much charge can be stored in it for a given potential difference across its terminals. The basic unit is the farad. However, the small microfarad unit is more commonly used: abbreviated MFD.

CATHODE: The general name for any negative electrode. In a magnetron tube, the cathode is centered within the anode and at high negative voltage potential.

CAVITY RESONATOR: A space totally enclosed by a metallic conductor and supplied with energy in such a way that it becomes a source of electromagnetic oscillations. In a microwave oven, the food compartment is a resonant cavity.

CHOKER: (1) An inductance (usually a coil) used in a circuit to impede the flow of pulsed DC or AC without appreciably affecting the flow of DC. (2) A groove, channel, or other discontinuity that is dimensioned so as to reflect guided electromagnetic waves of a certain frequency range.

CONVECTION: The transmission of heat by the mass movement of the heated air.

CORE: A magnetic material that affords an easy path for magnetic lines of flux.

CUMULATIVE EFFECT: Many exposures to small doses add up to a large dose.

CURRENT LIMITER: A protective device, used in some two-fold applications as a fuse that is designed to limit current flow in high-amperage circuits.

CYCLE: One complete positive and one complete negative alternation of a current or voltage.

DC VOLTAGE: An electric current that flows in one direction only, thus it is Direct Current.

DIELECTRIC: A material of poor conductivity that serves as an insulator, usually in reference to the insulating material between the plates of a capacitor. The dielectric separates the metal plates electrically, stores an electric charge, and undergoes polarization when subjected to an electric field.

DIFFERENCE OF POTENTIAL: The voltage existing between two points. If a circuit is established between the two points, a flow of electrons will result.

DIRECTLY HEATED CATHODE: A wire or filament that is designed to emit electrons when an electric current flows through it. The current heats the filament to the point where electrons are emitted.

DPC: Digital Programmer Circuit

DUMMY LOAD: A device used at the end of a wave-guide to convert transmitted energy into heat so no energy is radiated outward or reflected back.

DUTY CYCLE: In a magnetron tube: The ratio of oscillating time to total time.

ELECTRODE: The terminal at which electricity passes from one medium into another, such as in a humidity sensor unit where the current leaves or returns to the semi-conducting ceramic compound.

ELECTROMAGNETIC RADIATION: The process in which waves of electromagnetic energy are sent out into space.

ELECTROMAGNETIC WAVE: A wave of energy propagated by the combined interaction of electric and magnetic fields that are traveling at right angles to each other, and to the direction of travel.

ELECTRON: A high-speed, negatively-charged particle that revolves around the nucleus, and forms a part, of all atoms.

ELECTROSTATIC: Pertaining to electricity at rest or to stationary electricity (static electricity), such as a static charge on an object.

FERRITE: A ferric oxide material that has both magnetic properties and a high resistance to current flow. The high electrical resistivity makes any current losses extremely low at high frequencies.

FET: Field-effect transistor.

FILAMENT: A resistance wire or ribbon that, in a magnetron tube, is also the cathode. When an electric current flows through it, the filament heats up to a temperature by which electrons are liberated, thus the filament produces free (or floating) electrons.

FLUX: In electrical or electromagnetic devices, a general term used to designate collectively all the electric or magnetic lines of force in a given region.

FREQUENCY: The number of times a wave makes one full cycle in one second of time. Usually expressed in hertz (Hz).

FULL-WAVE RECTIFIER: A circuit that uses both positive and negative alternations of an alternating current to produce a direct current.

GROUND: Zero potential with respect to the ground or earth. A metallic connection with the earth is used to establish ground potential, and to provide a common return to a point of zero potential. When connected to a properly grounded and polarized circuit, the chassis of a microwave oven is at ground potential.

HALF-WAVE RECTIFIER: A circuit that uses only $\frac{1}{2}$ of each cycle to change AC to pulsating DC.

HARMONIC FREQUENCIES: Integral multiples of a primary frequency.

HEATER: See filament.

HEATSINK: A metal device that is clamped onto a heat-sensitive component for the purpose of diverting and dissipating soldering iron heat.

HENRY: The basic unit of inductance.

HERTZ: Cycles per second.

IC: Integrated Circuit. An interconnected network of electrochemical elements integrated into a tiny electronic circuit that performs at least one, and usually more, logic functions.

IEC: International Electro-technical Commission.

IMPEDANCE: A combination of resistance and reactance that offers opposition to the flow of current in a circuit. Impedance is usually expressed in ohms.

INDUCTANCE: The property of a circuit that causes a magnetic field to be produced which tends to oppose any change in the existing current flow. The basic unit of inductance is the Henry.

INDUCTION: The act or process by which a voltage is produced by the relative motion of a magnetic field across a conductor. Induction can also be define as, the process by which a magnetic field is produced by the variance of an electric current through a conductor.

INFINITE OHMS: An incalculably high amount of electrical resistance—essentially an open circuit.

INSULATOR: An implement having high electrical resistance, used for supporting, surrounding, or separating conductors so as to prevent undesired current flow between the conductors or to other objects.

INTERFACE CIRCUITRY: Serves to link the otherwise incompatible high-impedance circuits of the microprocessor and the high-potential circuits of external components.

ISO: International Organization for Standardization

IONIZING: The dislodging of orbital electrons from atoms, creating electrically charged, highly unstable, and chemically reactive atoms, called ions, which are damaging to living cells.

LAYER SHORT: A condition in a transformer in which two adjacent windings come into abnormal contact with each other through the insulating layer.

LC CIRCUIT: A circuit containing inductive reactance and capacitive reactance.

LCD: Liquid Crystal Display. A digital display, which utilizes a liquid crystal material to form digits and characters without generating any light. The liquid crystal material separates and is sealed-in by two sheets of glass, one of which has character-forming segments etched into it and serves as the viewing side. When voltage is applied to the electrodes that extend from each of the etched segments, the liquid adjacent to the segments changes tone (usually darkens), thus forming visible characters.

LED: Light-Emitting Diode. A semi-conductor diode that efficiently converts electric signals into light, and thus glows when current passes through it. In microwave ovens, LEDs are generally used for control panel displays and indicators.

LOAD: An object or device that consumes electrical energy, and thus changes the energy into another form. Food products change microwave energy into heat energy.

MEG OHM: One million ohms.

MICRO: A prefix meaning one-millionth.

MICROFARAD: One millionth of a farad; abbreviated MFD.

MICROPROCESSOR: A microprocessor incorporates various computer functions such as memory, calculation, data processing, and control into a tiny silicon chip. The microprocessor receives input and generates output signals in a sequence of logic, which is either externally programmed or internally preprogrammed.

MILLI: A prefix meaning 1/1000.

MILLIWATT: 1/1000 of a watt of electricity.

MODULATION/DEMODULATION: Modulation is the ability to impress intelligence upon a transmission medium. A transmission medium may be described as radio waves, light or infrared beams, wire lines, sound, or other communication systems. The characteristics (intelligence) of one waveform are impressed onto a second waveform by varying the frequency, amplitude, phase, or other characteristics of the second waveform. Demodulation is the removal or recovery of the intelligence from the medium.

MOSFET: Metal oxide semiconductor field-effect transistor.

NEGATIVE CHARGE: An electrical medium which has an excess of electrons, thus having the ability to repel electrons.

NEGATIVE TEMPERATURE COEFFICIENT: A factor that expresses the amount of reduction in the value of a quantity relative to ambient temperature. For example, a given decrease in a resistance for each degree of increase in temperature.

OHM: The basic unit of resistance. One volt will cause one ampere of current to flow through one ohm of resistance.

OPEN CIRCUIT: A circuit that does not provide a complete path for the flow of current.

OPTO-COUPLER: See photo-coupler.

PARALLEL CIRCUIT: Two or more electrical devices connected to the same pair of terminals so more than one current path is available. Current flows through each device in the parallel circuit.

PHASE: The relationship in time and polarity between two waves. A phase difference results when one wave leads or lags another.

PHOTO-COUPLER: An isolated coupling device which, when energized by an input, sends a signal to a semiconductor switching device, such as an SCR.

POLARITY: The relative condition of being positive or negative with respect to a given potential.

POLARIZED RECEPTACLE: A receptacle designed to ensure that the neutral side of an AC line is always connected to the neutral side of an appliance, such as a microwave oven.

POSITIVE CHARGE: An electrical medium that has become deficient in electrons, thus having the ability to attract electrons.

POTENTIAL: The amount of charge held by a body as compared to another point or body. A difference in voltage potential between two connected points results in current flow between the two points. The difference in potential is measured in volts.

PROTONS: One of the fundamental particles of the nucleus of an atom and carries a unitary positive charge.

RADIATION: The process of emitting radiant energy in the form of waves or particles.

RC CIRCUIT: A circuit having a resistance and a capacitance in series.

RESONANCE: The condition produced when the frequency of vibrations is the same as the natural frequency of a cavity. The cavity is sympathetic to the frequency; thus, the vibrations reinforce each other.

RESONANT CIRCUIT: (explained in detail in part 3) A coil and capacitor connected in parallel form a capacitive-inductive resonant circuit. Energy supplied to the circuit will charge up the capacitor. When the energy supply is removed, the capacitor discharges through the coil. Current flow through the coil causes a magnetic field to develop around coil. The magnetic field then collapses around the coil, self-inducing a current flow in the opposite direction, which then charges the capacitor in the opposite polarity. Consequently, the capacitor discharges again, starting the process all over.

SCR: A semiconductor device that is controlled by a gate signal. Normally the SCR acts as an open switch, but upon application of an appropriate gate signal to its gate terminal, the SCR instantly switches to a conducting state, becoming as a closed switch.

SERIES CIRCUIT: An arrangement of electrical devices that are connected so that the total current must flow through all the devices in order to complete the circuit.

SHORT CIRCUIT: A low resistance (usually zero ohms) connection across a voltage source or between two points in a circuit that are of different electrical potential. A short circuit usually results in excessive and possibly damaging current flow.

SOLENOID: An electromagnetic coil that contains a movable plunger.

STANDING WAVE: The distribution of waves in a reflective enclosure in which the waves coincide at maximum and minimum points on a resultant wave that appears to stand still.

SUBSONIC: Sound waves beyond the lower limits of human audibility.

SYNTHESIZER: See Voice Synthesizer.

TERMINAL: (1) A point to which electrical connections can be made. (2) The electrical input or output of a circuit or component.

TRIGGER: A short pulse, either positive or negative, which can be used to cause an electrical function to occur.

TUNING STUB: A rod, screw, or post of conductive material that projects into a wave-guide for one or more of the following purposes: impedance matching, producing desired phase relationships, or to minimize reflected energy.

ULTRASONIC: Pertaining to sound waves having a frequency that is generally above the limits of human audibility.

VOICE SYNTHESIZER: An instrument that simulates speech by digital control. The synthesizer assembles and digitizes the various elements of a dialect, so the appropriate inflections and other speech characteristics of any language can be simulated.

VOLT: The unit of electrical potential (electromotive force or electrical pressure). One volt is the pressure required to send one ampere of current through one ohm of resistance.

VOLTAGE: Voltage is the force (or pressure) that causes current to flow through a conductor. The voltage of a circuit is the greatest effective difference of potential between any two conductors of a circuit.

VOLTAGE DROP: Ratio of voltage (or electrical pressure) lost (or dropped) across a specified load as a result of forcing current flow through that load.

WATT: The practical unit of electric power. In a DC circuit, one watt of power is used when one ampere of current flows through a resistance of one ohm.

WAVEGUIDE: A rectangular, circular, or elliptical hollow metal tube designed to transport electromagnetic energy through its interior from one point to another.

WAVELENGTH: (1) The distance in space occupied by one cycle of an electromagnetic wave at any given instant. (2) The distance a wave travels during one cycle.

Prepared by:
César Perdomo
Panasonic Services Company
National Training Department
Secaucus, NJ

 **Warning**

This service information is designed for experienced repair technicians only and is not designed for use by the general public. It does not contain warnings or cautions to advise non-technical individuals of potential dangers in attempting to service a product. Products powered by electricity should be serviced or repaired only by experienced professional technicians. Any attempt to service or repair the product or products dealt with in this service information by anyone else could result in serious injury or death.