

※Thank you for selecting this series solar charge controller, please read this specification before using the product.
 ※Please keep this specification for the further reference.

MPPT SOLAR CHARGE CONTROLLER

1. OVERVIEW:

Thank you for selecting MPPT series solar charge controller with the most advanced MPPT control algorithm and the maximum power point of the pv array can be quickly tracked in any environment so that it can get the maximum energy from the solar panel and significantly improve the utilization of energy in solar system. The machine has the dual display function of LCD and Remote meter (optional) and standard communication interface, convenient for user extension application and satisfy different monitoring needs to the maximum extent. It can be used in communication base station, home power supply system, traffic light, solar street lamp, courtyard lamp system, etc. The features are listed below:

- Advanced MPPT maximum power point tracking technology, the tracking efficiency is no less than 99.5%.
- High quality components are used to improve the system performance, and the maximum conversion efficiency can reach 97%.
- Super fast maximum power tracking speed while ensuring tracking efficiency.
- Accurate identification and tracking of the maximum power point of multi-wave peak.
- Reliable maximum input power of pv array to ensure the safety of equipment.
- Wide pv array maximum power point operating voltage range.
- 12/24v automatic voltage identification
- The LCD is designed to dynamically display the operation data and working status of the equipment.
- Various load control modes: general mode, light control mode, dual time mode, pure charger mode .
- Seal, GEL, Flooded, LifePO4 and Li(NiCoMn)O2 charging process can be selected.
- The function of battery temperature compensation.
- Power statistics recording function.
- Use the RS485methods to maximize the communication needs of different occasions.
- Support PC monitor, external display unit and other peripherals, realize real-time data view and parameter setting function.

2. PRODUCT APPEARANCE:

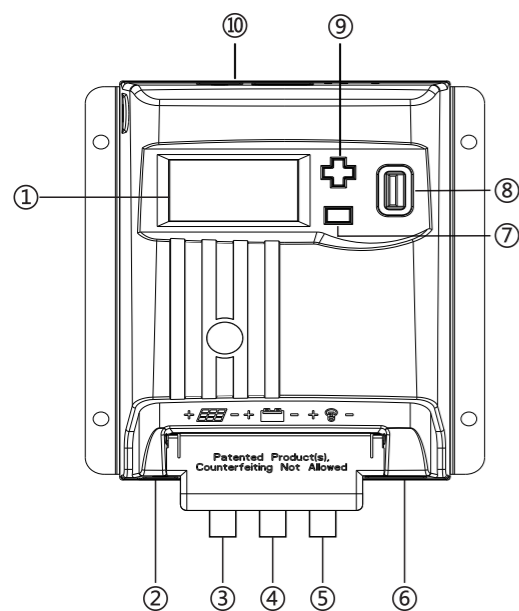

Photo 1 Appearance

1

①	LCD
②	Temperature sensor interface(Selection)
③	Photovoltaic array terminals
④	Battery terminal
⑤	Load terminal
⑥	Rj45 communication interface(Selection)
⑦	■ Button
⑧	USB output
⑨	+ Button
⑩	Cooling board

NOTICE: In the case of the remote temperature sensor not connected, the controller will compensate the charging parameters by 25°C for the battery temperature.

※ Except for 10A, the others are double USB and the total output of USB is 1.2A.

3. WIRING

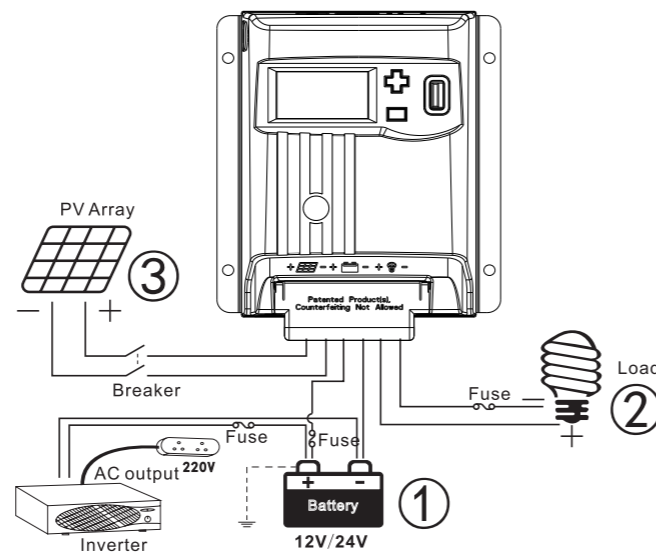

Photo 2 Connection diagram

Order of connection:

- ①Connect battery
Notice: The battery terminal shall be installed with insurance, and the installation distance shall not exceed 50mm.
- ②Connected Load
- ③Connect pv array
- ④Controller is powered on

Connect the battery, identify the voltage of the control system and observe whether the display screen is lighted. If it doesn't work or the display is abnormal, refer to section 6 for troubleshooting.

NOTICE: This series of MPPT is a common positive controller, pv array, battery and load of the positive pole can be grounded at the same time.

NOTICE: If the inverter or other starting current is loaded in the system, please connect the inverter directly to the battery. Do not connect with the controller's load terminal.

2

4. INTERFACE

4.1Buttons

Mode	Remarks
load switch	When the load is manual mode, by short pressing - button can switch the load.
Breakdown	Pressing the - button shortly.
Browse mode	Pressing the + button or - button shortly.
Setting mode	long press + button enter the secondary browsing interface and then press + or - to browsing interface, long press + button again to enter the setting mode, short press + button or - button to set parameters, then long press + button to save the Settings. Long press - button or 15 seconds without keystroke operation will exit secondary browsing interface (parameter not saved)

4.2 LCD

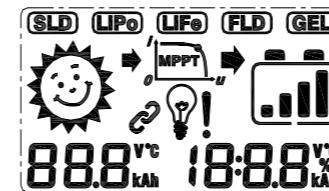

□ Status introduce

Item	ICO	Status
PV array		Day
		Night
Battery		Uncharged
		Charging
		Battery soc
		Battery type
Load		load on
		load off

4.3 BOOT SCREEN

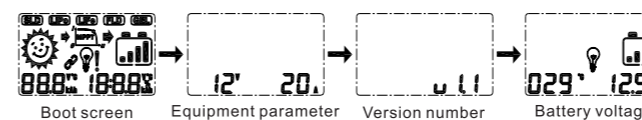

- (1)Starting interface: it is normal to detect LCD when the system is powered on.
- (2)Equipment parameter: Controller current system voltage and rated current.
- (3)Software revision.
- (4)Battery voltage interface: Battery voltage and. ambient temperature .

3

Notice: At the first level browse interface long press **+** button to enter the secondary browsing interface .It will automatically exit the secondary browsing interface without doing anything for 15 seconds.

First-level browsing interface

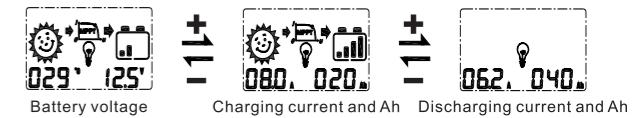

In the main loop interface, press the **+** or **-** button to enter the browsing mode, and long press the button **+** to enter the secondary browsing interface.

□Secondary browsing interface under the condition of battery voltage interface.

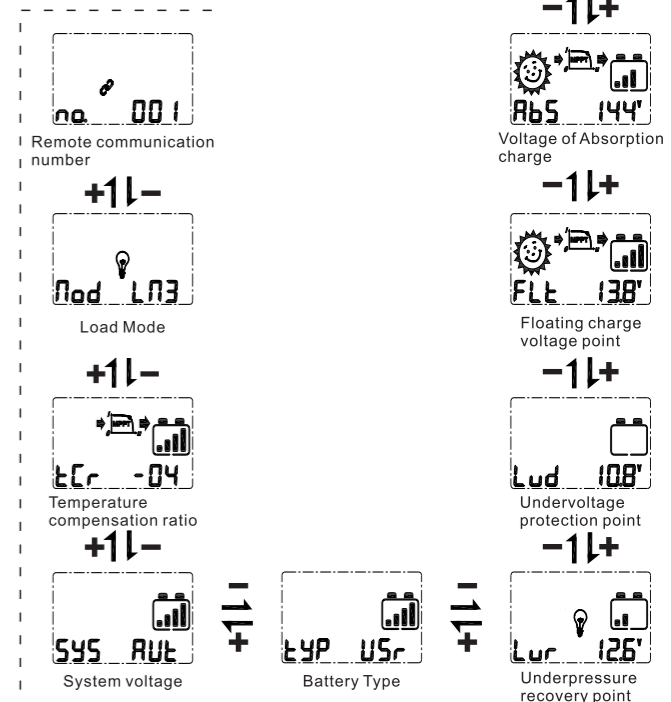
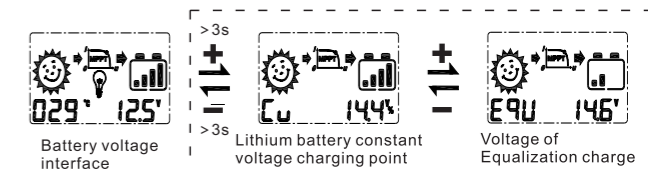

Long press the **+** button in the main loop of the battery voltage interface to enter the secondary browsing interface, short press the **+** or **-** button switch to the secondary browsing interface, long press the **+** button to enter the setting interface, short press **+** or **-** button to set the parameters and long press **+** to save .It will automatically exit the secondary browsing interface without doing anything for 15 seconds.

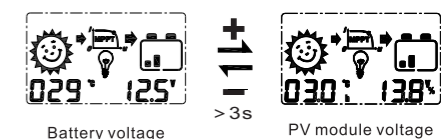

In the main loop of the battery voltage interface long press **-** button, Switch to display solar array voltage (The % symbol serves as a distinction) and internal temperature of the controller (The letter h serves as a distinction)

4

The load pattern is as below:

CODE	LOAD PATTERN
L01 (LM1)	Regular Mode
L02 (LM2)	Light control mode
L03 (LM3)	Dual time mode
L04 (LM4)	Charge only mode

Dual time mode

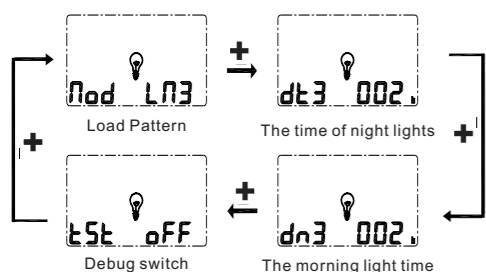

In load mode 3 (LM3), long press the + to enter the setting interface, then short press + or - to set the parameters and save after long pressing + button.

Fault Indicator

Status	Chart display	Specification
Voltage shortage of storage battery		Flicker
over voltage of storage battery		Flicker
Overloading trouble		Flicker

4.4 Battery type

Six types of batteries for user choosing: User default, Sealed, Flooded, GEL, LiFePO4, Li(NiCoMn)O2. Among them, User default, LiFePO4, Li(NiCoMn)O2 can be changed parameters.

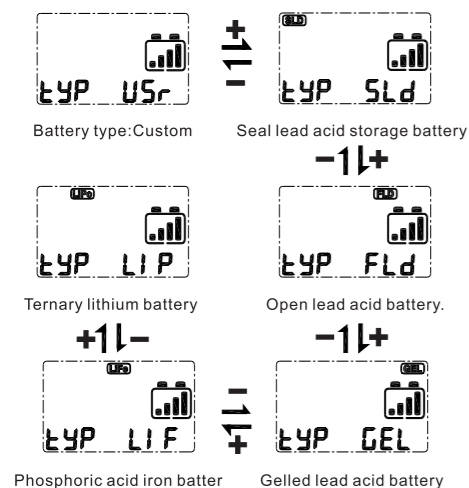

4.5 System voltage selection.

long Press + in the system voltage interface, enter the setting interface, short press + or - to select system voltage, long press + again to save the selected system voltage.

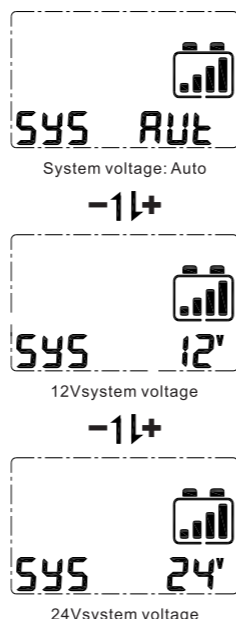

4.6 Restore factory Settings.

long Press + for 3s to enter the factory setting in main loop charging current interface

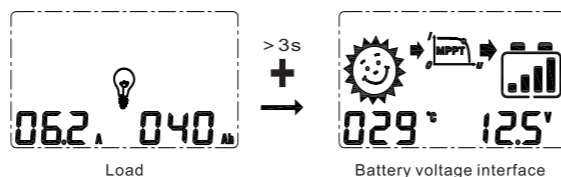

5. Protection Function

Protection	Condition	Status
Solar panels is reversed	Solar panel can be reserved if Battery is not connected	Controller isn't broken
Battery is reversed	Battery can be reserved if PV is unconnected	
Battery over-voltage	Battery voltage reaches the over-voltage point	Stop charging and discharging
Battery over-discharge	Battery voltage drops the under-voltage point	Stop discharging
Over-load	The load current is over the rated current	Turn off the output

Note: You can short press + key to eliminate the error code.

6. Fault Management

Error code	Cause	Correction
No sign on the LCD when there is enough sunlight	Solar panel is disconnected	Check if connection of solar input is right and contact is reliable.
No sign on the LCD when connection is right	1. Battery voltage is less than 8v 2. Voltage of solar panel is less than battery voltage	1. Check battery voltage. Controller will start only Battery voltage is more than 8v 2. Voltage of solar panel must be more than battery voltage.
E1 (Ex1)	Battery Over-discharge	Load output is turned off automatically and recovers when battery electricity is enough.
E2 (Ex2)	Over voltage of storage battery	Please check whether the battery voltage exceeds the voltage and reconnect the solar panel.
E3 (Ex3)	Over-load	Reduce load or check load connection
E5 (Ex5)	Over temperature	Make the controller cool down and restart charging automatically.
E6 (Ex6)	Input voltage of solar panel is too high	Check power of solar panel and reduce quantities of solar panel in parallel.

7. Technical data

Rated charge current	10A	20A	30A	40A
System rated voltage	12/24V Auto recognized			
Voltage range of battery	8V-32V			
Max open voltage of solar panel	100V/150V(Optional)			
Battery type	User default, Sealed, Flooded, GEL, LiFePO4, Li(NiCoMn)O2.			
Equalized charging voltage ✘	Maintenance-free lead-acid battery :14.6V,GEL:No;Lead-acid Flooded battery: 14.8V			
Absorption charging voltage ✘	Maintenance-free lead-acid battery :14.4V,GEL:14.2V ;Lead-acid Flooded battery: 14.6V			
Float charging voltage ✘	Maintenance-free lead-acid battery, GEL, lead-acid Flooded battery :13.8V			
LVR ✘	Maintenance-free lead-acid battery, GEL, lead-acid Flooded battery :12.6V			
LVD ✘	Maintenance-free lead-acid battery, GEL, lead-acid Flooded battery :10.8V			
Static loss	≤45mA/12V;≤37mA/24V;			
HVD	16V			
Duration of absorption charging	2hs			
Duration of equalized charging	2hs			
Light control voltage	5V			
Temperature compensation coefficient	-4mV/°C/2V(25°C)			
Discharge loop voltage drop	≤0.2V			
LCD temperature	-20°C ~ +70 °C			
Operating temperature	-20°C ~ +55 °C			
Storage temperature	-30 ~ +80 °C			
Working humidity	≤90%, No condensation			
Protection class	IP30			
Grounded type	Positive grounded			
Dimension	155.5*127*42.5mm	174.5*145*50mm	195*160*60mm	215.5*174*65mm
Hole size for installation	117*100mm	135*110mm	150*120mm	164*160mm
Aperture for installation	Φ5mm			
Terminal wiring	10mm ² /7AWG		16mm ² /5AWG	
Net weight	0.360kg	0.525kg	0.835kg	1.125kg
Optional function	Remote communication,			

✘ Above the parameters are in 12V system at 25°C,twice in 24V system.

Subject to change without notice.