



# 2 CHANNEL MULTI-PURPOSE RECEIVER

 N517

Rhino Part N <sup>o</sup> .	Description
RCX	<ul style="list-style-type: none"><li>• 2 Channel receiver</li><li>• Keyless Entry</li></ul>
RCXi	<ul style="list-style-type: none"><li>• Keyless Entry with immobilisation relay (includes automotive installation parts)</li></ul>

Version 2

---

## Instructions

---



**RhinoCo Technology**  
ABN: 74 001 621 610

**Head Office:**

9 Hannabus Place, McGraths Hill, NSW 2756  
AUSTRALIA

Ph: +61 (2) 4577 4708 Fax: +61 (2) 4577 4885

**Web:** [www.rhino.com.au](http://www.rhino.com.au)

**Email:** [sales@rhino.com.au](mailto:sales@rhino.com.au)

16 Pages Total



# Introduction

---

This product is designed to be **simple and easy to use**. It has simple wiring connections and can be used in a **variety of applications**. Primarily, this product can be used to remote control your car, garage door, home alarm system, or your electric gate. The list of items you can interface into is almost endless.

The unit is supplied with 2, dual button remote controls which have an **operating range of approximately 80 metres** (line of sight – subject to environmental conditions).

The remote controls for this unit operate using **code hopping technology**. This is otherwise known as anti code grabbing or anti scanning type. This leading edge technology prevents unauthorised copying of your remote control. This technology sends a unique and different code each time any of the remote control buttons is pressed.











## Other features include:

---

- ✓ Long life lithium batteries included with the remote controls.
- ✓ Compact receiver module, which can fit in the smallest of spaces.
- ✓ High performance and reliable super-heterodyne receiver. This ensures there is no frequency drift.
- ✓ SSR™ Solid State Remote controls – no tuning capacitor. More durable and reliable.
- ✓ New modular design. Plug in module. Easy to install, replace or service.
- ✓ Learning code receiver. Can store up to 15 remote controls in total.

## Packing List

Following, is a list of the parts included with your receiver.

Description	Appearance	Re-order code	RCX	RCXi
RCX Receiver module		RCXTH	Yes	Yes
8 way wiring harness		HARNESS08	Yes	Yes
2 button remote controls (2 pieces)		GTTX	Yes	Yes
Instruction booklet		INSTRUCTIONS	Yes	Yes
Warranty Cards		WTYCARD	Yes	Yes
1 Amp diode		1N4007	No	Yes
40 Amp relay		40ARELAY	No	Yes
LED, Loom and Bezel		LEDLOOM5	No	Yes
Toggle Switch and Loom		TOGSWLOOM	No	Yes
Special Indicator Flash Relay (pre wired)		REL01LOOM	No	Yes



# Installation

---

## Notes for Automotive Installation

- Plug the wiring harness in to the module last, after all connections have been made.
- Check the vehicles electrical system thoroughly **before** commencing installation.
- The installation should be as well hidden as possible - to maximise the system security.
- **Solder** all connections, and then **insulate** with insulation tape.
- Use a **multi - meter** to verify any wires nature.
- The immobilisation override switch is an option at the customer's discretion. It will disable the immobilisation system. Its location should be known to the installer/owner only. When the switch is **open** the system will be **disabled**.

**IMPORTANT: If the installer does not have a concise knowledge of the vehicle's electrical system, it is strongly advised not to aimlessly probe to find the necessary wires. Doing so may damage your vehicles electrical system. Consult with your vehicle's manufacturer, or a qualified Auto Electrician. Rhino accepts no responsibility if an installer wires the product incorrectly or damages the vehicle during installation.**

## Notes for RCX Home / Generic Installation

- Plug the wiring harness in last, after all connections have been made.
- Check the alarm panel manual or other ancillary device manual thoroughly **before** commencing installation.
- The installation should be as well hidden as possible - to maximise the system security.
- Use a **multi - meter** to verify any wires nature.

**IMPORTANT: If the installer does not have a concise knowledge of the alarm panel, garage door controller, or other ancillary device, it is strongly advised not to aimlessly probe to find the necessary wires. Doing so may damage the system. Consult the manufacturer or a qualified alarm technician. Rhino accepts no responsibility if an installer wires the product incorrectly or damages an ancillary device during installation.**

# Automotive (RCXi)

## Installation

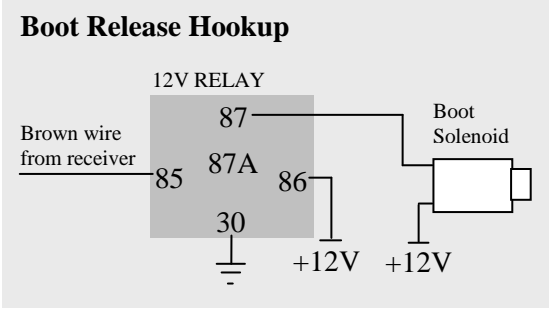
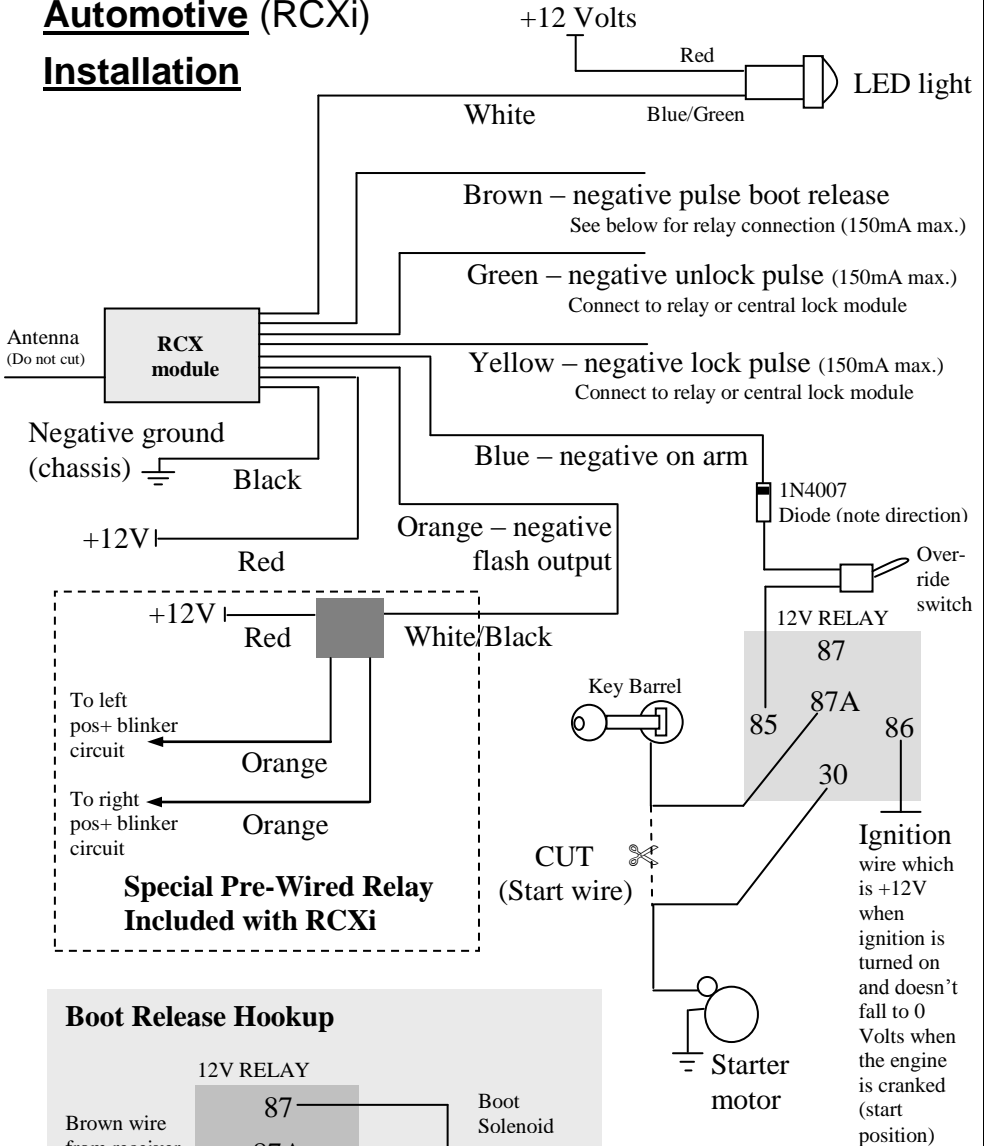

**IMPORTANT!**  
 All outputs from the RCX(i) are rated at 150mA (max.)



## Additional Wiring Information (Automotive - RCXi)

16cm WHITE WIRE	- This is the antenna wire. Do not cut. This wire must be as straight as possible and kept away from metal surfaces as much as possible.
RED WIRE(s)	- Connect to constant <u>fused</u> +12 Volt DC supply (minimum 15 Amps) i.e. Has +12V when the ignition is turned off, via fuse box. <b>WARNING:</b> Do not connect power to the red wire until the green and yellow wires are fully insulated. If the red power wire touches the green or yellow wire, damage will be caused to the central lock outputs. This is not covered under warranty.
BLACK WIRE	- Negative Ground. Connect this wire to the chassis or a point on the vehicle's body. Ensure that any paint is removed for a good connection. You may also wire directly to the negative terminal on the car's battery.
GREEN WIRE	- Negative pulse Unlock (1 second pulse). For use with central locking. (If fitted). Refer to diagrams page 15 & 16.*
YELLOW WIRE	- Negative pulse Lock (1 second pulse). For use with central locking. (If fitted). Refer to diagrams page 15 & 16.*
ORANGE	- Negative Flash output. Connect to the white wire with black trace on the special pre-wired relay supplied. One flash for lock, two for unlock.
BROWN	- Connect to a relay (not supplied) to drive a boot release motor. (150mA maximum rating)
BLUE WIRE	- This wire is a negative out when armed. (150mA maximum rating) Connect to the 40Amp Changeover Relay (supplied with RCXi) to isolate a circuit in the vehicle when the system is armed. Can also be used to trigger an electric window lift interface (Rhino part: GLU400) if required. <b>IMPORTANT:</b> Do not short this wire to 12V. Solder this wire to number 85 on the immobilisation/cutout relay.
WHITE WIRE	- Connect to the negative wire (blue/green) from the LED. Connect the positive side (red) of the LED supplied, directly to the fused +12V supply. (The RCXi has a 1k resistor built into this output)
ORANGE X 2 (From indicator relay)	Connect one orange wire to the left positive and one orange wire to the right positive indicator circuits in the vehicle.
DIODE	- Solder the diode between the blue wire from the module and one side of the override switch (refer to the diagram), with the band on the diode closest to the module. Diode part: 1N5404
IGNITION WIRE FROM VEHICLE	- The ignition wire is usually located under the steering column of the vehicle. This wire must be +12V only when the vehicles key switch is at the ignition position, and must not fall to 0 volt when the engine is cranked. Strip a section of this wire and solder a wire onto the bared section. Solder the other end of this wire to number 86 on the relay.
STARTER / FUEL PUMP WIRE FROM VEHICLE	- The starter wire is usually located under the steering column of the vehicle. This wire must be +12 Volts only when the vehicle is being started. Cut this wire and the vehicle should not start. If the vehicle does start then you have cut the wrong wire. Solder the starter motor side to number 30 on the relay. Solder the other end to number 87a on the relay. Disable only fuel pump or starter motor if vehicle is not EFI. Rhino does not recommend cutting the vehicle's ignition wire from the key barrel.

\* Additional central locking hookup diagrams available from Rhino Technical Support

# General Purpose 1 Channel or 2 Channel Installation

(RCX)

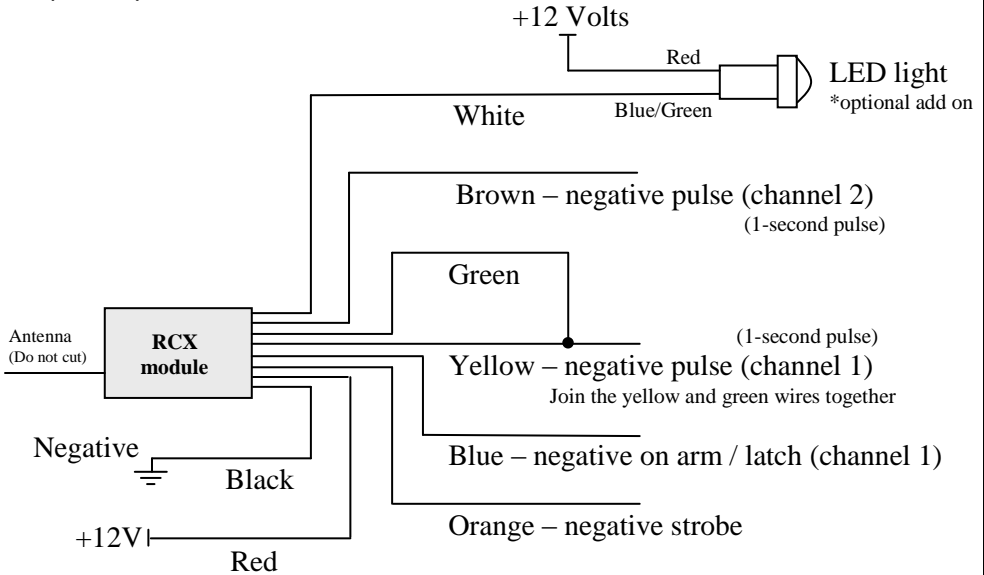

## Relay Hookups

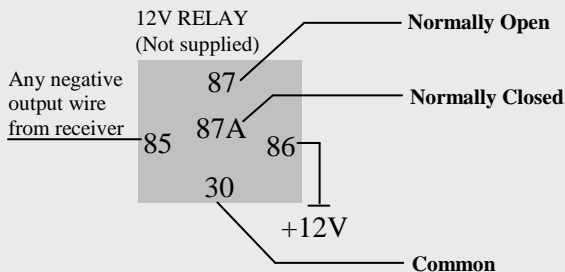

### IMPORTANT!

All outputs from the RCX(i) are rated at 150mA (max.)



## Additional Wiring Information (Generic - RCX)

16cm WHITE WIRE	- This is the antenna wire. Do not cut. This wire must be as vertical, straight, and must not be enclosed within any metal casing, which the module may be mounted in. The full length of the antenna must extrude the metal enclosure.
RED WIRE(s)	- Connect to constant <u>fused</u> +12 Volt DC supply (minimum 1 Amp) i.e. usually +AUX on an alarm panel or a constant 12 Volt supply. <b>WARNING:</b> Do not connect power to the red wire until the green and yellow wires are fully insulated. If the red power wire touches the green or yellow wire, damage will be caused to the outputs. This is not covered under warranty.
BLACK WIRE	- Negative Ground. Connect this wire to the negative (GND) or usually -AUX on an alarm panel. This is usually where the negative supply for detectors are connected also.
GREEN and YELLOW WIRES	- Negative pulse Channel 1 (1 second pulse). Refer to diagrams. (150mA maximum rating)
ORANGE	- Negative strobe output. Refer to strobe connection diagrams.
BROWN	- Negative pulse Channel 2 (1 second pulse). Refer to diagrams. (150mA maximum rating)
BLUE WIRE	- This wire is a negative out when armed / latch channel 1 (150mA maximum rating). <b>IMPORTANT:</b> Do not short this wire to 12V.
WHITE WIRE	- Connect to the negative wire (blue/green) from the LED. Connect the positive side (red) of the LED (not supplied) directly to the +12V supply. (The RCX has a 1k resistor built into the output)

## Harness Connection

The harness must be plugged in as shown otherwise the unit will not operate. This should be done last when all the wires have either been connected or insulated.

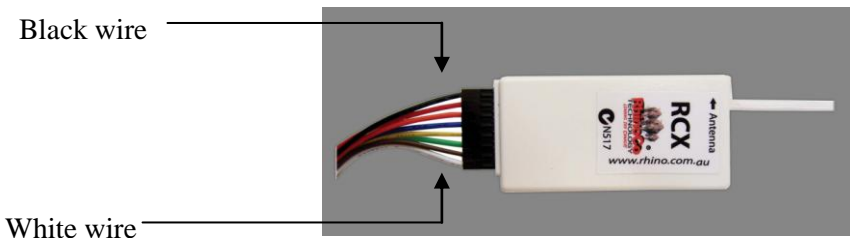

*\* If you plug the harness in the wrong way it will not damage the module.*



## Strobe Connection Diagrams (Generic – RCX)

For negative strobe outputs drawing less than 150mA

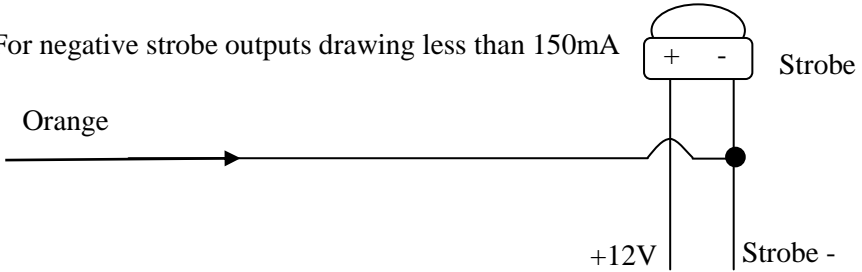

For positive strobe outputs, use 40A Relay

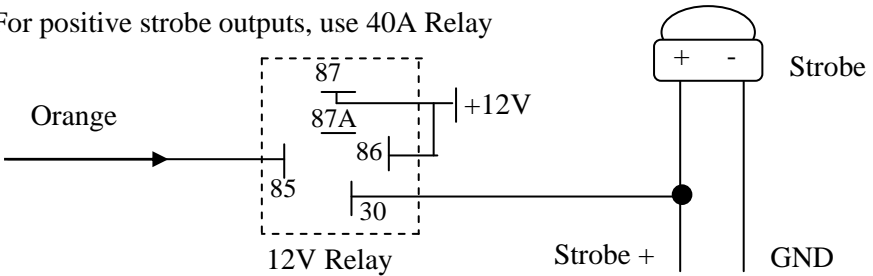

For negative strobe outputs drawing more than 150mA

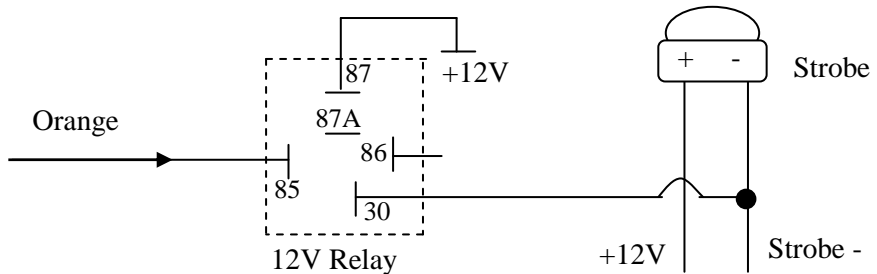

## Blinker Relay Diagram (Supplied with RCXi only)

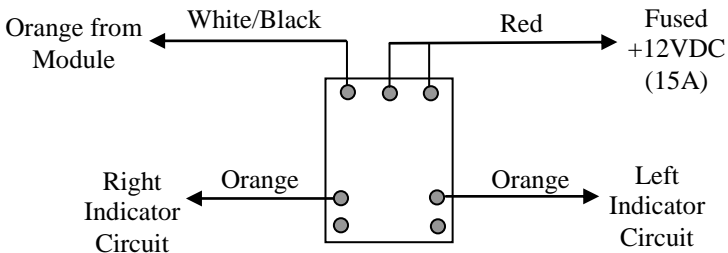

# Operation

---

## Normal Operation (Automotive – RCXi)

### Red button

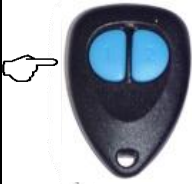

**Unlock  
Lock**

Press button 1 to **lock and unlock** the vehicle. When the vehicle is locked this will immobilize the vehicle. The dash LED light will begin flashing and the indicators will flash once.

When the vehicle is unlocked the dash LED light will stop flashing. The indicators will flash twice and vehicle can now be started.

### Green button



Press button 2 to open the **boot** (if connected). This operates independently and will not lock or unlock the doors. It will not enable the vehicle to be started if the vehicle is already immobilised.

## **Normal operation (general purpose – RCX)**

As this receiver may be wired to many different devices, we suggest that you fill in the spaces below.

### **Red button**

Press button 1 to operate Channel 1.



This will \_\_\_\_\_  
\_\_\_\_\_  
\_\_\_\_\_

### **Green button**

Press button 2 to operate Channel 2.

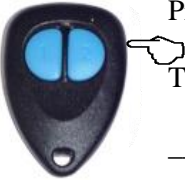

This will \_\_\_\_\_  
\_\_\_\_\_  
\_\_\_\_\_

## **Installers notes to the user**

\_\_\_\_\_  
\_\_\_\_\_  
\_\_\_\_\_  
\_\_\_\_\_



## Adding remote controls

Your RCX / RCXi incorporates a unique code learning system. This enables extra remotes to be added with ease if necessary. Up to 15 remotes can be added to system if required.

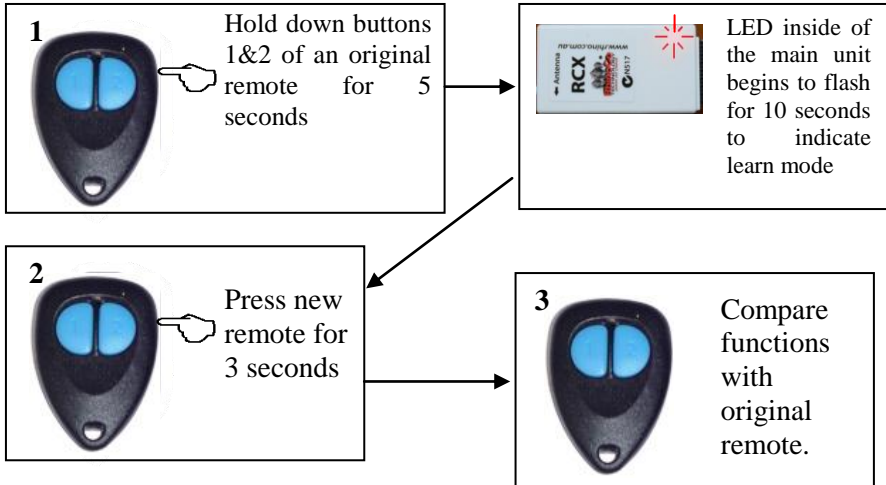

### **To learn in a new remote control:**

- 1) Press and hold buttons 1&2 of an original (learnt in) remote control together for approximately 5 seconds (LED inside the main unit will be flashing fast during this time) or until the LED inside of the main unit begins to flash once every half second for 10 seconds to indicate learn mode.
- 2) Immediately release the buttons on the original remote then press and hold button 1 of the new remote control for approximately 3 seconds.
- 3) Your RCX should now have learnt the new remote control - test this by comparing functions with the original remote control. If the learn procedure was unsuccessful, retry the procedure from step one.

## Override



If you have no working remote controls to operate your system because they have been lost or are not working then you may over-ride the RCXi system (if the over-ride switch has been fitted). The switch should be in a hidden position and switched in the opposite direction to enable you to start the vehicle.

The RCX, if wired to a control panel, can usually be overridden by using the hardwired keypad. It is important with any installation to ensure that an override procedure is in place in the event that all remote controls for the system are lost or are not operating.

### **Lost Remotes?**

If you are unable to find lost remotes you should have the system sent back to the Rhino Service Department for resetting. This is important to ensure that no unauthorised entry can occur from someone using the lost remote control(s).

Contact the qualified installer for removal and refitting of the system. For technical assistance contact Rhino Technical Support (details below).

## **Testing & Specifications**

- We recommend using a multi-meter to test any wires.
- All outputs are open collector switching negative.

### **NORMAL OPERATION RATINGS**

PARAMETER	MINIMUM	TYPICAL	MAXIMUM
Supply current @ Vcc = 12V	-	7mA	13mA
Supply voltage (Vcc)	10V	12V	14V
Operating Temperature (°C)	-20	+25	+85

### **ABSOLUTE MAXIMUM RATINGS**

PARAMETER	MINIMUM	MAXIMUM
Storage Temperature	-55	+150
Supply Voltage, Vcc Max.	0V	+16V

# Service and Technical Support

## Replacing the remote control batteries

The diagram shows how the remote control is assembled. This may help when it comes time to replace the batteries in your remote control.



A small Philips head (#1) screw driver is required to remove the 2 screws that hold the case together. Once the screws are removed you can then disassemble the case and replace the batteries.

The batteries must be installed the correct way (see diagram below).

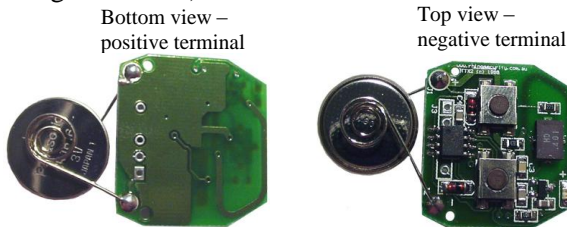

Both batteries are placed between the 2 terminals. The positive side of each battery faces the bottom. The positive side of each battery is indicated by a + symbol. Be sure not to touch the face of the new batteries with your fingers. Handle only from the edge so that the batteries make good contact with each other and the terminals.

Side view with  
batteries installed

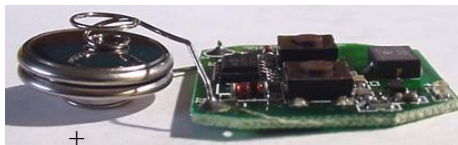

Replacement batteries are available from Rhino Electronic Security. Contact Rhino Technical Support on the number below.

Rhino Part #	Battery type	Description
TX3V	CR1616	3 Volt button cell Lithium battery

## Additional Diagrams

All relays depicted are changeover type.

### Connecting to a Rhino Central Locking Kit (CLK)

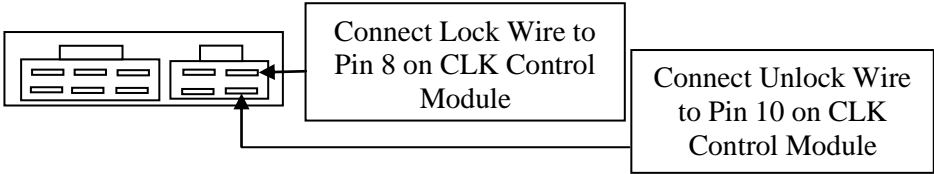

### Installing a New Motor

(Often required in vehicles that has factory locking but have no motor in the driver's door, or you would like "keyless entry" on driver's door)

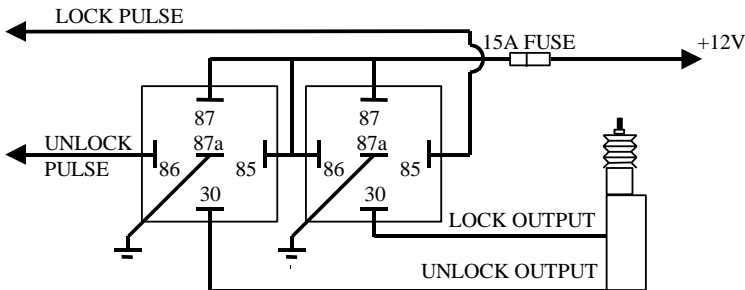

### Interfacing to "Positive Pulse" Central Locking Systems

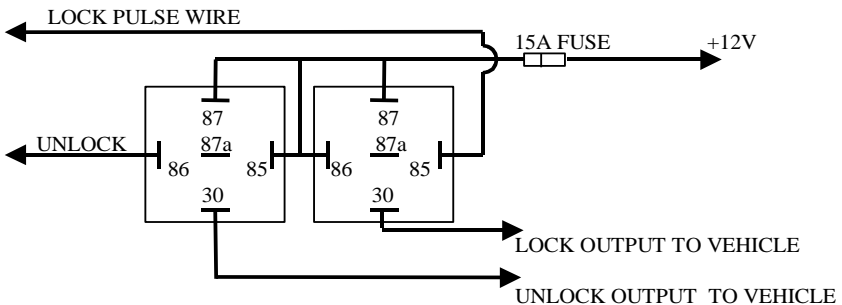



## Negative Trigger Existing Central Locking System (low current)

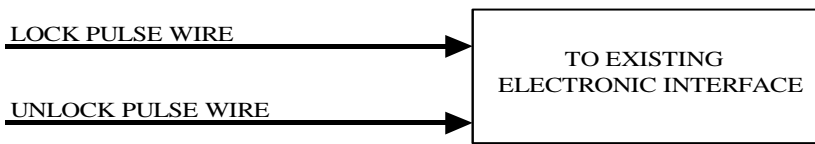

## Additional Central Locking hookup diagrams available from Rhino Technical Support

- Secure unlocking (similar to VS/VT central locking system).
- Positive at rest then going negative or negative at rest then going positive.
- Other various central locking hookups.
- Wiring colours and locations for various model vehicles.



We thank you for buying an Australian designed and engineered product from an Australian company



[www.rhino.com.au](http://www.rhino.com.au)