

### Dimensions

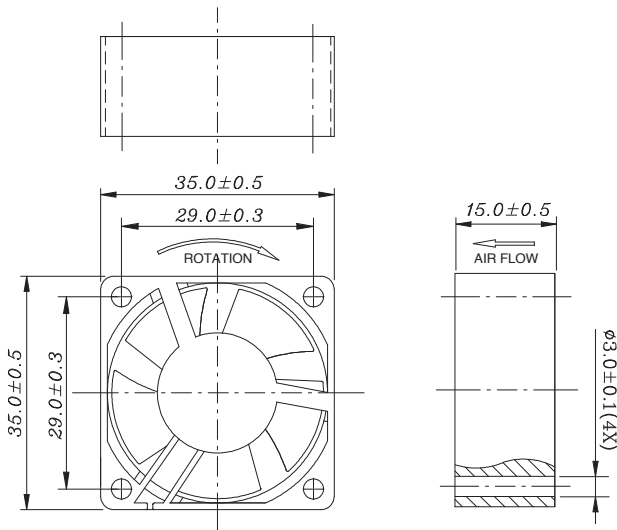

### Performance Curves

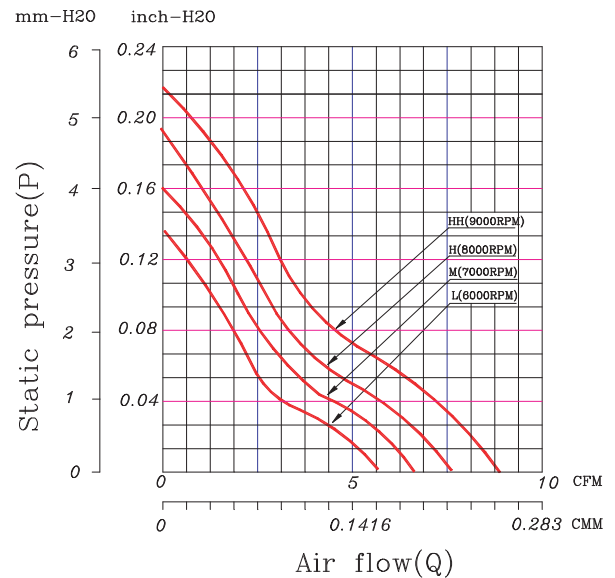

Air exhaust over struts. Rotational direction CCW looking at rotor.

Brushless DC Motor	Bearing Type
Weight: 16g Impedance protected Lead wire UL 1095 AWG 28	Ceramic

\* All fans are with electronic protection against reverse polarity. The fan only operates when the polarity is correct.

Function Options	
<input checked="" type="checkbox"/> Frequency Generator	<input checked="" type="checkbox"/> Auto Restart

- \* Please contact us for PWM function availability.
- \* Please contact us for IP55 availability.
- \* Safety Approval: CE, UL, TUV

### Specifications

Model	Rated Voltage (VDC)	Rated Current (Amp)	Input Power (Watts)	Nominal Speed (RPM)	Airflow (CFM)	Static Pressure (inch -H2O)	Noise Level (dBA)
FAN3515C5HH	5	0.28	1.40	8000	7.60	0.19	30.00
FAN3515C5H	5	0.22	1.10	7000	6.65	0.16	26.00
FAN3515C5M	5	0.17	0.85	6000	5.70	0.14	23.00
FAN3515C5L	5	0.12	0.60	5000	4.75	0.12	19.00
FAN3515C12HH	12	0.16	1.92	9000	8.55	0.21	34.00
FAN3515C12H	12	0.14	1.68	8000	7.60	0.19	30.00
FAN3515C12M	12	0.11	1.32	7000	6.65	0.16	26.00
FAN3515C12L	12	0.08	0.96	6000	5.70	0.14	23.00

\* Specifications are subject to change without prior notice.

\* Check with your distributor for models available.